

The Radio Dealer

Published Monthly by
The Radio Dealer Co.,
1133 Broadway, New
York, N. Y.

VOL. I No. 6

For The Radio Retailer

SEPTEMBER, 1922

Application pending for
entry as second class
matter at the Post Office
at New York, N. Y.

ONE DOLLAR THE YEAR

SATURN AUTOMATIC PLUG

**The More You Pull
The Better the Connection**

No more taking apart to make connections. Just insert the terminals into the Saturn and a perfect connection is made. So constructed that pulling on the cords makes the connection more positive. Let your customers try this test themselves. It will convince them that Saturn is far superior to any plug on the market.

List
\$1.50



**Instantaneous Disconnection
Just by touching this Lever!**

A simple move and both
cords are instantaneously dis-
connected. Another feature
that makes the Saturn Plug
easy to sell.

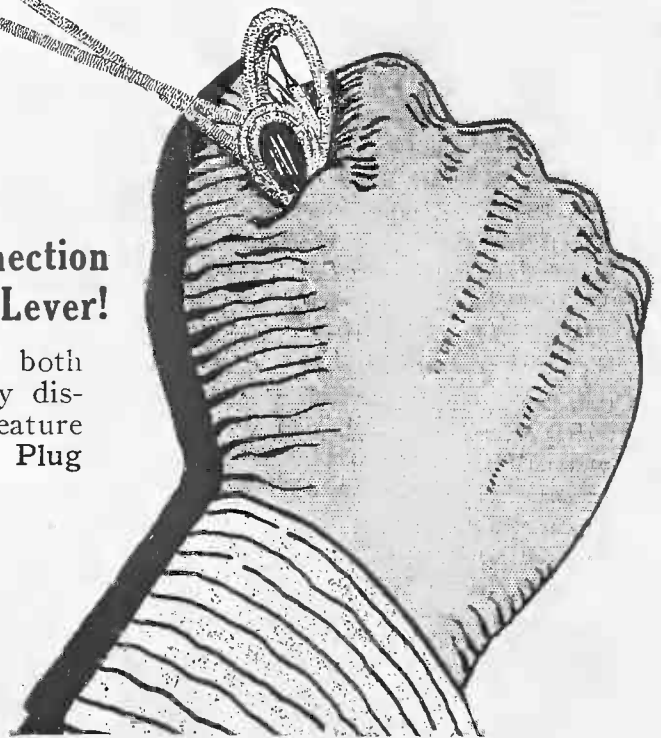

**The Only Perfect Automatic
Plug!**

A bold statement? We wouldn't make it if it couldn't be proved. Fully covered by patent application. You know that the Saturn is the kind of a plug you'd buy for yourself. So will your customers, if you give them a chance to see it and make this test. Just a small trial order of Saturn Plugs will show you a new source of profits. Write for catalog and discounts.

NORTH WARD RADIO CO.

72 A Orange St.

Newark, N. J.

**DISTRIBUTORS FOR
Brandes Superior
"Matched Tone" Head Sets**

**De Forest Radio Equipment
(Attractive new discounts
in effect)**

**Marle Audio Frequency
Transformers**

**FIVE SIZES OF JACKS
and other products of
distinguished quality**

The RECENT CHICAGO SHOW:

Resulted in quantity orders from concerns ranging from Florida to California on:

THE RADIO BUILDER SET

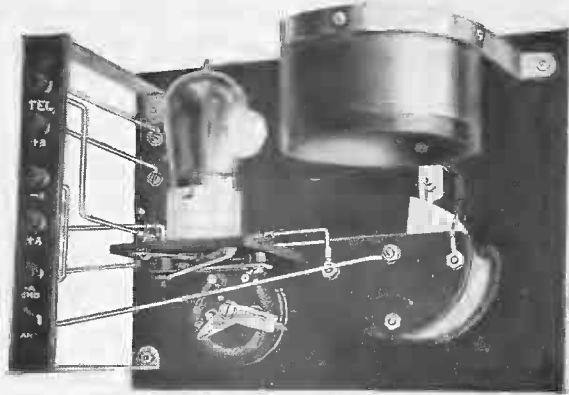

Shipped to customer in "knock-down" form and requiring only a screwdriver and a few moments to *complete* its assembly. When finished it provides a vacuum tube set which is very selective, giving extremely loud and undistorted signals..... **\$25.00**

Some dealer propositions still open

The above type set is available in one, two and three tube form

RAYMOND RADIO CORPORATION

Manufacturers to the Radio Industry

Offices: 309 Lafayette Street, New York

Works: Farmingdale, L. I.

SUNRAID

Patent Pending

PRODUCTS

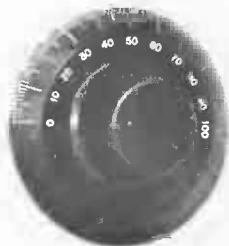

List
Price
3 in. \$ 1.00
4 in. \$ 1.50

Dials

The new improved SUNRAID DIALS are of one solid piece of moulded condensite. The Dials are so constructed that when mounted on a panel they set off 1/32 of an inch from the surface of the panel, which gives a maximum of efficiency in smooth operation—no gripping.

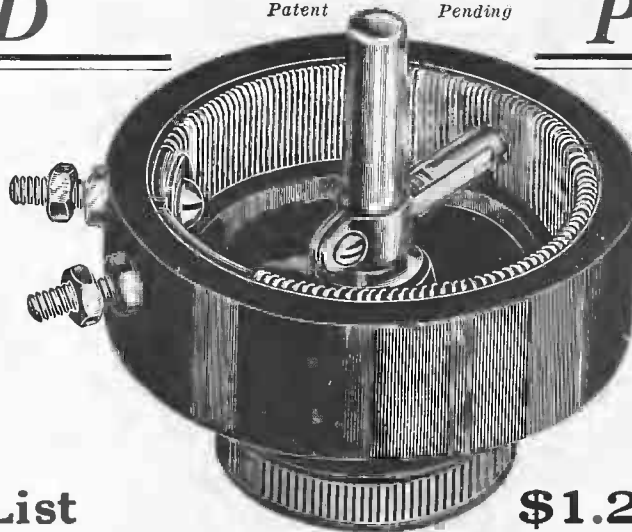

List

Rheostats

\$1.25

Radio men who want a Rheostat of high class workmanship that gives a maximum amount of service will find it worth their while to buy the SUNRAID RHEOSTAT. It gives perfect contact against winding at all times. (See spring attachment in above photograph.)

Windings guaranteed not to jump out.



List
Price
\$1.25

Plugs

SUNRAID PLUGS are made of the best of material—casement of pure bakelite with a high polish. These plugs will take cords with spade or wire tips.

SUNRAID PRODUCTS are guaranteed. Distributors wanted for all parts of the world. Write for proposition. DISTRIBUTORS—Samples will be sent to you C. O. D. upon request.

SUNRAID
534 EIGHTH AVENUE



RADIO CO.
NEW YORK CITY, U.S.A.

DEALERS

Does Service Mean Anything to You

PATRONIZE an organization for radio men, rendering personal, intimate and harmonized service with every article it sells.

DISTRIBUTING a high grade line of radio apparatus including the products of the most prominent manufacturers such as Radio Corporation, Westinghouse, De Forest, Clapp-Eastham, etc., apparatus manufactured in accordance with the latest designs and theories—apparatus guaranteeing you quality workmanship and rendering maximum results under working conditions.

DISTRIBUTORS FOR	
Radio Corp. of Am. (Westinghouse)	
General Electric	
Brandes	Baldwin
Acme	Amrad
Brach	Jacobus
Federal	Magnavox
Fada	Pacent
Hopewell	Signal
Cutler-Hammer	
De Forest	
Clapp-Eastham	
and others	

R-E SERVICE

*DEPENDABLE
EFFICIENT
SATISFYING*

WHEN in town drop in to see us. We will always be here to greet you with a glad hand, ready to render an "Individual Service" that will make you a satisfied customer.

OUR literature is yours for the asking and to request it does not obligate you in any way.

JUST OFF THE PRESS! Our New Data Sheets on Armstrong's Super Regenerative Circuit. All parts ready for immediate delivery. Dealers Write for Special Quotations

MAIL ORDERS SHIPPED PROMPTLY

THE RADIO  **ELECTRIC CO.**
Manufacturers and Jobbers in

RADIO EQUIPMENT

1427-29 LIBERTY AVENUE
PITTSBURGH, PA.



**THE SATISFIED CUSTOMER
IS THE DEALER'S GREATEST ASSET**

HE CAN ONLY BE OBTAINED
THROUGH THE SALE OF RELIABLE GOODS

**Federal
RADIO APPARATUS
SATISFIES**

THE MOST EXACTING DEMANDS

We Manufacture

A LINE OF COMPLETE INSTRUMENTS AND PARTS UNEXCELLED

in beauty of form and finish, Simplicity of Operation, Efficiency and Durability,
INCLUDING
Receiving Sets, Amplifiers, Transformers, Head Telephones, Rheostats, Potentiometers, Jacks, Plugs, V. T. Sockets, Knobs, Dials, Anti-Capacity Switches, Condensers, Battery Containers, etc.

ALL OF GREATEST RELIABILITY AND FULLY GUARANTEED

IF YOU SELL **Federal** APPARATUS
YOU SELL **SATISFACTION** THAT ENDURES

Write for Catalogue No. 115-W, and Dealer's Discount

Federal Telephone & Telegraph Co.

BUFFALO, NEW YORK

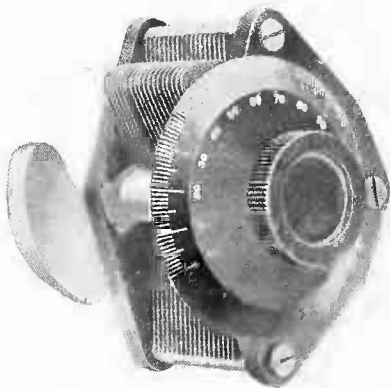
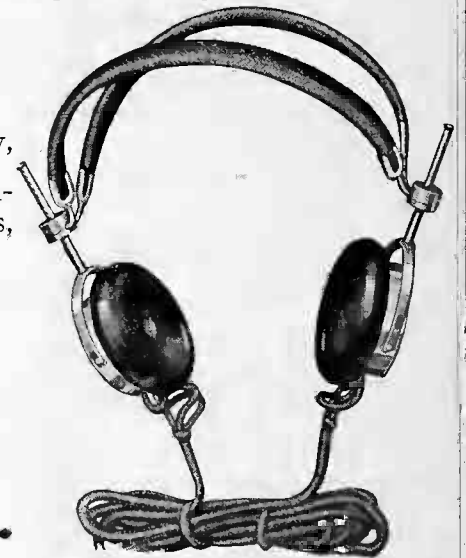

No. 3 Price \$4.75

Amplifying Transformer No. 50

The Chelsea Amplifying Transformer gives the highest amplification possible and at the same time will not squeal, howl, or in any way cause noisy circuits. It is beautiful in design and embodies electrical characteristics unequalled by any. Guaranteed for all circuits up to 500 volts with a high safety factor.

It will not fail in service.

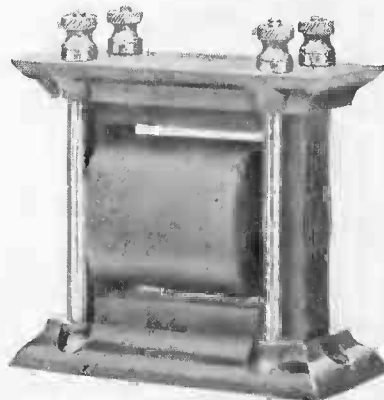

Price \$4.50

CHELSEA

Variable Condensers
(Die-Cast Type)

- No. 1.—.0011 m. f. mounted \$5.00
- No. 2.—.0006 m. f. mounted 4.50
- No. 3.—.0011 m. f. unmounted 4.75
- No. 3.—.0011 m. f. unmounted, without dial... 4.35
- No. 4.—.0006 m. f. unmounted 4.25
- No. 4.—.0006 m. f. unmounted, without dial... 3.85

Top, bottom and knob are genuine bakelite, shaft of steel running in bronze bearings, adjustable tension on movable plates, large bakelite dial reading in hundredths, high capacity, amply separated and accurately spaced plates.

Unmounted types will fit any panel and are equipped with counterweight.

Guaranteed for circuits up to 1,000 volts.



Price \$3.00

**No. 21. Variable Grid Leak
(Patented)**

Our variable grid leak consists of ten carefully calibrated values of leak resistance ranging from 1/4 to 5 megohms.

By proper adjustment of the grid leak the potential of the grid and hence the signal strength is accurately controlled. This results in the operation of the tube at its highest efficiency and with the elimination of all squealing and tube noises.

Purchase Chelsea Radio Equipment from your dealer. If he does not carry it send to us. Write for our new No. 6 Catalog

CHELSEA RADIO CO., 150 Fifth Street, Chelsea, Mass.

Manufacturers of Radio Apparatus and Moulders of Bakelite and Condensite

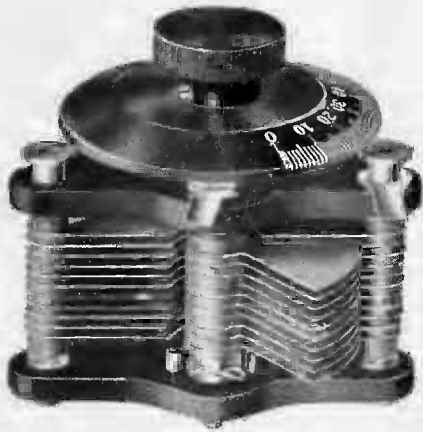

WRITE FOR
RADIO BULLETIN
No. 15

—CHELTEN—

- Complete line of Jacks
- Radio Plugs
- Filament Rheostats
- Dials and Knobs
- Variable Condensers
- Grid Condensers
- Phone Condensers
- Variable Grid Leaks
- V. T. Sockets
- Radio Switches
- Crystal Detectors
- Lightning Arresters
- Antenna Receptacles

C. T. R. RADIO
PRODUCTS

Our large manufacturing facilities combined with Experience and Craftsmanship enable us to offer the BEST

CHELTEN VACUUM TUBE
PANEL UNITS

CHELTEN ELECTRIC CO.

4859-65 STENTON AVE.

PHILADELPHIA, PA.

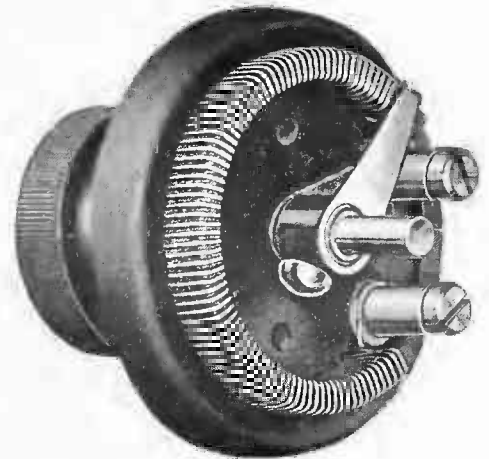

NATIONAL

SEAMLESS TUBING

in Large Diameters

For Vario-couplers, Variometers, Tuning Coils and wherever you use large diameter fibre tubing, National Seamless Tubing is less expensive and infinitely superior.

National Seamless Tubing is a specially developed, laminated tubing that retains its form and will not warp, swell or shrink. Exact in both diameters and easily worked.

Can be furnished in dark gray fibre, black fibre or dipped in insulating varnish.

Any quantities, diameters from 3" to 4 1/2" I. D. Any wall from 3/32 up.

Give us your specifications. We'll send samples and prices.

National Fibre for Panels

Hard Black Panel Stock of good dielectric strength. Gives satisfaction for condenser tops and bottoms, rheostat bases, washers, bushings, etc. Let us quote on the stock itself, or on completed parts machined to order.

Peerless Insulation

The standard thin weight fibre insulation or "fish paper."

NATIONAL FIBRE & INSULATION CO.

Box 452, YORKLYN, DELAWARE

NEW YORK
CHICAGO
PHILADELPHIA

DETROIT
SAN FRANCISCO

CLEVELAND
OMAHA

PITTSBURGH
BOSTON

ROCHESTER
BIRMINGHAM

ST. LOUIS
BALTIMORE
LONDON, ENGLAND

In CANADA, National Fibre Co. of Canada, Ltd. TORONTO



No. 47541
Simplex Condenser
Panel—Side View



No. 47488
Simplex Variometer,
Showing Side View of
Panel Mounted Type

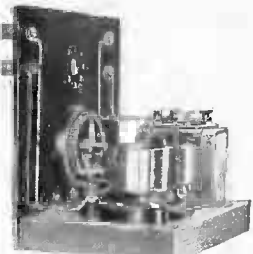

No. 47491
Simplex Amplifier Panel
Side View

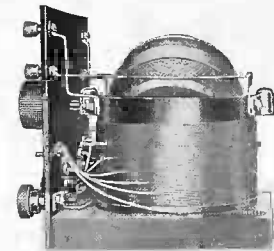

No. 47489
Simplex Vario-Coupler,
Showing Side View of
Panel Mounted Type

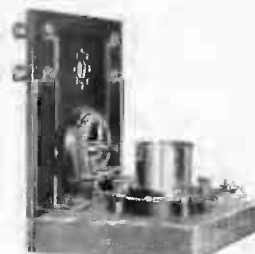

No. 47490
Simplex Detector Panel
Side View

SIMPLEX PANEL UNITS AND KEYSTONE RADIO LIGHTNING ARRESTERS

Write for Dealer Proposition

With Simplex Panel Units the user can easily change his hook-up and thus always have the benefit of the latest ideas in radio circuits. These are high-grade instruments and should be carried in every dealer's stock. Complete data and discounts on request.

Keystone Radio Lightning Arresters are approved by Underwriters; have no vacuum tube which in a short time loses and makes an arrester valueless. Weatherproof, sealed and fool-proof. Thousands and thousands in use. Write for discounts.

Electric Service Supplies Company

Manufacturers of Lightning
Arresters for 30 years

Distributors for Simplex Radio Co.

Philadelphia, 17th and Cambria Sts.; Pittsburgh, 829
Oliver Bldg.; Scranton, 316 N. Washington Ave.;
Boston, 88 Broad St.; New York, 50 Church St.;
Chicago, Monadnock Bldg.

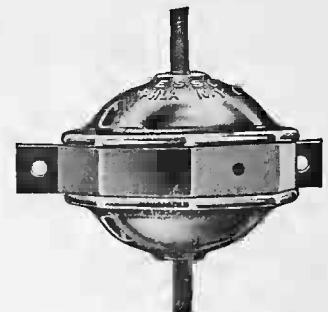

Type A, Keystone Radio
Arrester. Retail Price, \$2.00

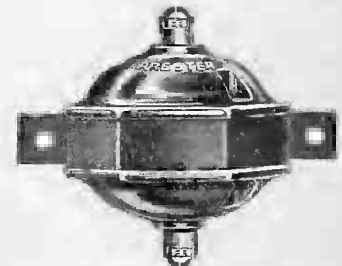

Type B, Keystone Radio
Arrester. Retail Price, \$2.00

This Quality Radio Apparatus is Priced to Attractive Levels. It Guarantees You a QUICK TURNOVER!

Mr. Dealer and Jobber: This line is without an equal in workmanship, finish, design and high-grade appearance. Place your orders *at once* with us. Be prepared for a rush of early Fall business with a line that is sure to repeat.

IMMEDIATE DELIVERIES ON LARGE QUANTITIES

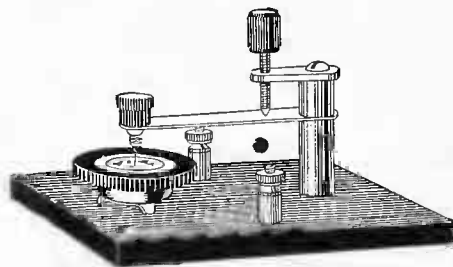

Type X. "The Whiz" Crystal Detector. Extremely sensitive. Triple adjustments—horizontal, vertical and circular—assure very sharp and clear receiving. It stays in adjustment until moved by hand. Sturdy in design and efficient in use. High-grade composition base, parts are solid brass highly nickled. Knobs are condensite. Individually tone-tested and guaranteed Pathfinder Crystal Point furnished with every instrument. Satisfactory service fully guaranteed. List \$1.50.

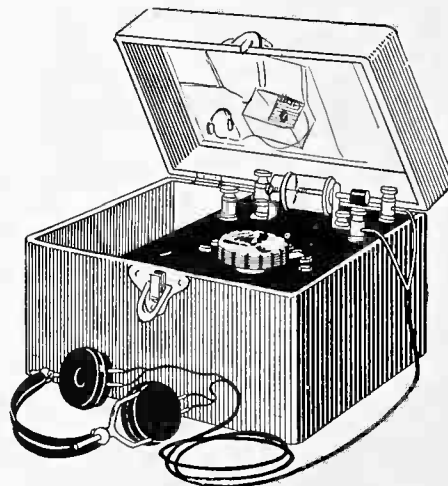

Type JR-2. Crystal Receiving Set. Complete with 2,000 ohm phones and A. & J. Glass-enclosed Crystal Detector with Pathfinder Crystal Point. Case is hand-rubbed mahogany with mitered joints. Scientifically constructed according to best practices. Gives A-1 results and stays sold. List, \$20.00.

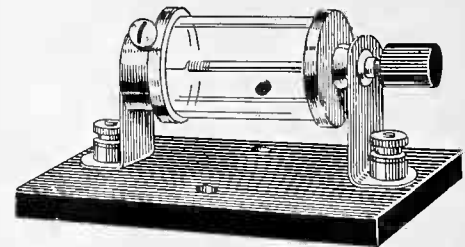

Type H2 (Assembled). "Baby Wonder" Crystal Detector. All that is implied by the name. This marvelous glass-enclosed instrument gives unusual service with tuner. Phosphor bronze contact point, concealed spring, ball swivel and friction slide. Superior quality sells it at the low list price of \$1.00.

Type H3 (Unassembled). Parts complete. Neatly packed. Easy to assemble. Base not included. List 85c.

AYAN-JAY SALES COMPANY

2918 Prairie Avenue

'Phone Calumet 4916

CHICAGO, ILLINOIS

WRITE WIRE OR 'PHONE FOR DISCOUNTS



Generous Profit, Rapid Turnover, Customers' Good-Will Orders, or Repeat Business?—

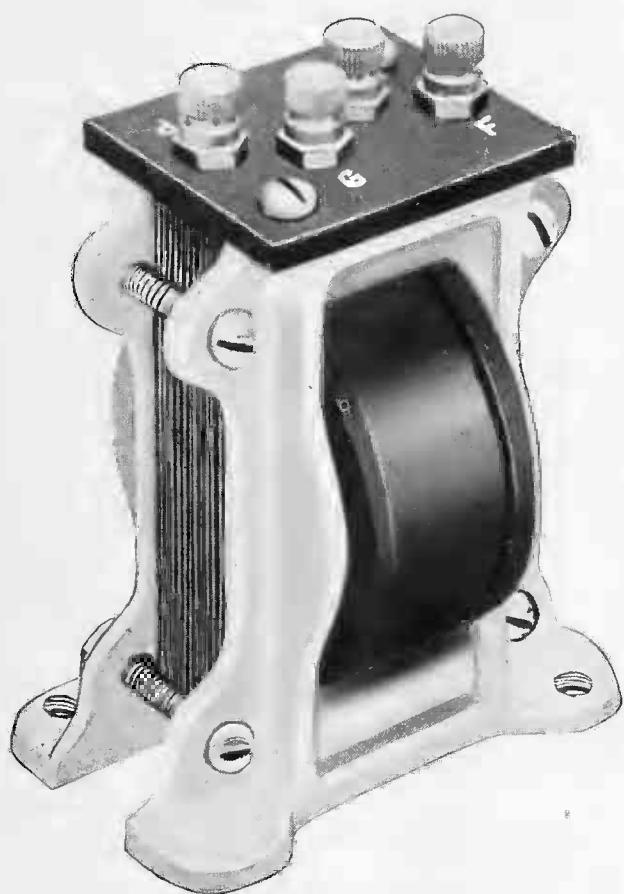

RETAIL PRICE, \$6.00

Maximum amplification without distortion. No exposed wiring to break or short. Can't be incorrectly connected. No impregnating compounds used for insulation, thus losses and rumbling noises are avoided. Tested for 600 volts A.C. Ideal for power amplification. Sell the 3 Y Q Transformer for use with any present day V T or any circuit.

The 3 Y Q safely meets the exceptional demands of the new Armstrong Super-Regenerative Circuit.

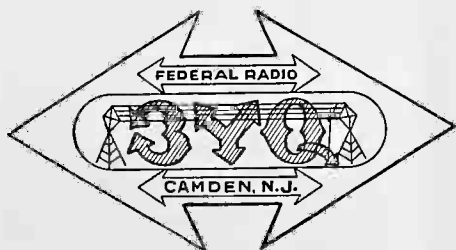

You Get All Four Selling 3 Y Q Audio Frequency Transformers

The 3 Y Q Audio Frequency Transformer gives you a generous profit because our price to the jobber and the jobber's price to you are both fair and designed to let you both make a living. The turnover is rapid because the reputation of the 3 Y Q Transformer is travelling ahead of it and as soon as your customers get using it another reputation is being made to your benefit.

Your customers will send their friends to you for 3 Y Q Transformers because a totally new principle of construction, discovered by a foremost Radio Technician, makes the 3 Y Q Transformer the most efficient of all Audio Frequency Transformers. This means good-will orders for you.

Repeat business follows from all who buy. If customers do not require more transformers for experimental work they return to you for their other needs because the 3 Y Q Transformer has proved to them that you sell EFFICIENCY as well as quality and service.

The 3 Y Q Transformer will not bring you any replacement business of the kind that wants a refund because the primary is open or because the wiring is burned out. EVERY 3 Y Q TRANSFORMER IS TESTED TO STAND 600 VOLTS A.C. BEFORE BEING SHIPPED FROM OUR FACTORY. This means satisfied customers and less operating expense to you.

Order 3 Y Q Transformers from your jobber. Ask for them by name and if you have any difficulty in getting them write to us, giving your jobber's name. We will see that you are supplied. Write at once for a free supply of our descriptive circulars for counter distribution. They help you.

Federal Institute of Radio Telegraphy
CAMDEN, N. J.

Over 10,000,000 People Will Read

About *Super-Antenna* Units

Our National Advertising Campaign starting September in the following Magazines is bound to create a Big Demand.



DEALERS!

JOBBER!

Will Your Cash Register Ring Up Your Share of Profits?



This "Super-Antenna" Unit

has been designed by *Mr. Robert Duncan, Jr., Chief Engineer of U. S. Signal Corps, Bureau of Standards, Washington, D. C.*, for Radio Reception over electric light-wires.

No Outside Aerial Necessary

This unit is made to conform to the requirements of the National Board of Underwriters. Is shock-proof—will not blow fuses—or damage receiving set.

Eliminates Lightning Hazards —

saves cost of antenna, switches, lightning arresters, and installation of same.

Insert plug in any light socket. Has 8 separate hook-ups giving perfect results, on any circuit. **List price..... \$2.80**
West of Rockies, \$3.00; Canada, \$3.70.

Order Your Stock At Once

SUPER-ANTENNA CO.

Dept. 149

QUINCY, ILL.

The F. R. L. Super-Receiver

has 2 Stage Radio Frequency and 2 Stage Audio Frequency Amplification. This set is 6 months ahead of any unit on the market. Made according to the most exacting standards.

30 Mile Range Without Antenna or Ground

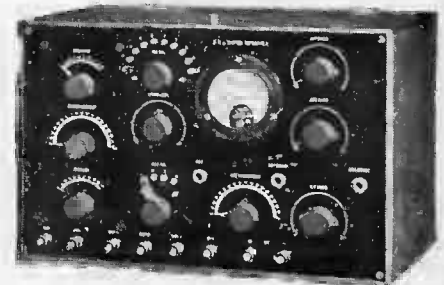

Most sensitive and efficient set made. Price, including tubes, \$240.00.

Descriptive Circulars

of our Super French Variometer and Variocoupler, our Hill Variable Condensers and Super Amplifier, will be sent on request.

Wire or Write Today for Attractive Discounts.

M U - R A D



MU-RAD MA-12 Receiver

SUPER

*Sensitive
Efficient
Value*

SETS

A REVELATION after regarding the ordinary set as the highest attainment of the art. *Mu-Rad* Sets have such delightfully distinct, clear tones—"natural as life." Work on small loop or coil. Stations 200 miles away can be clearly heard with a 3-inch pick-up coil. With tubes, batteries, phones and a loop, these sets are complete receivers. Beautifully finished and assembled with expert care. *Quality from start to finish.*



MU-RAD MA-13 Receiver

M U - R A D Amplifier Transformers

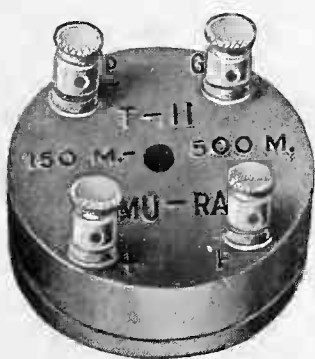

*Increases Range
Eliminates All Distortion
No Iron Core
No Howling or Squealing*

Wave-Length
Range

160—500 Meters

Mu-Rad Amplifier Transformers are exactly what thousands of crystal set owners and more advanced amateurs are looking for. These transformers give twice and more the amplification of iron core transformers. Not affected by low frequency or audio sounds. These are easily demonstrated **ADVANTAGES** that mean *good profits* for the dealer.

*The Name Sells Them—
Their Performance Brings
New Business*

THE *Mu-Rad Laboratories* have no real competitors. They boldly left the beaten track, casting off the burden of generally accepted handicaps, and produced greatly advanced apparatus. A simple comparison proves that *Mu-Rad Products* have more than mere claims in their favor.

Now that the tide of inferior merchandise is going out, the large radio buying public, its wisdom teeth well cut, says, Missouri-fashion, "Show me." You can show them, gain their confidence and more than hold your own if you sell *Mu-Rad Products*. Many know from past experiences the value of these unusually good instruments; others by reputation and the rest will quickly see the difference.

Our discounts allow you to make a worthwhile profit. Our methods of doing business will please you.

Your Inquiry Will Receive Prompt, Careful Attention

MU-RAD LABORATORIES, Inc.
806 Fifth Avenue - - Asbury Park, N. J.

Let Your Apparatus Speak for Itself

AMERICAN RADIO EXPOSITION

—A national exposition for radio manufacturers, dealers, inventors and amateurs, covering the entire field of radio.

—A complete exhibition of apparatus, accessories and materials.

—Daily demonstrations, broadcasting, lectures, orchestral concerts, Grand Opera artists in person, motion pictures illustrating practical uses of radio and the principles of its operation.

To be held at

Grand Central Palace

46th St. to 47th St. and Lexington Avenue

—The heart of the great terminal zone, close to the busiest shopping districts.

NEW YORK CITY

DECEMBER 21st to 31st, 1922

—Schools and colleges will be closed, making it convenient for young folk to attend. To these young people the magic of radio makes a specially strong appeal.

Manufacturers and dealers should contract for space now.

Address inquiries as to rates, etc., to

AMERICAN RADIO EXPOSITION COMPANY

120 Broadway, New York City, Telephone, John 0009

Educational and Interesting

GREGG SERVICE

For the Manufacturer

Gives an accurate, unbiased check on new models.

Rates and tests equipment that is under consideration by set assemblers.

Aids in the designing of instruments and parts.

Direct patent searches.

Gives service on the designing of plants, plant lay-outs by efficiency engineers, who get value out of every inch of floor space.

Checks costs and production methods.

The GREGG O.K. marks radio equipment that
ALWAYS MAKES GOOD

*Executives interested should write for appointment, with officials of
our RADIO DEPARTMENT*

GREGG & COMPANY

ENGINEERS

St. Louis, Mo.

Newark, N. J.

Radio Department

Washington, D. C.

Los Angeles, Cal.

Mexico City, Mexico

165 Broadway

New York

Gould Radio "A" Batteries are used by the various Radio Branches of the U. S. Government. Built for dependable, continuous service. Made in sizes from 60 A. H. to 160 A. H.



Retail Prices
\$17 to \$29
(f. o. b. factory)

A Fine Radio Receiving Set Deserves these Quality Batteries

THESE newest additions to a Famous Battery Family—the Gould "A" and "B" Radio Storage Batteries—are designed and built for Radio work by a manufacturer with over a generation of experience in making railroad, submarine, central station and automobile batteries.

Gould Radio Batteries are built by the same men who build the Gould Automobile Battery, known for "Longest Life by Owners' Records." They are equipped with the same

rugged Dreadnaught Plates and Armored Separators. No finer Batteries can be produced.

Gould Radio "B" Batteries are exceptionally compact owing to the unique insulating features of their design—require no more shelf space than a dry battery—provide a steady, continuous, noiseless service—are easily recharged and if given proper care will last many years.

Write for Gould Dealer proposition

GOULD

GOULD STORAGE BATTERY COMPANY
30 East 42nd St., New York Works: Depew, N. Y.



Patents Applied For
Retail Price
\$8.50 (f. o. b. factory)

The Gould Radio "B" Battery is uniquely designed, compact and attractive. Provides 24 volts variable in 2-volt steps. Non-slipping hard rubber case. A battery that does not detract from the appearance of the finest set and assures a steady, continuous, noiseless service. Ask any Radio Dealer.

RADIO EQUIPMENT SERVICE

(Trade Name Registered)

Offers an Exceptional
Proposition to Dealers

Write for Details

National
Distributors of
a Complete
Line

500 FIFTH AVENUE
NEW YORK CITY

RADIO EQUIPMENT SERVICE

Announces

A Sure Sales Builder,

RADIOLITE

Registered U. S. Patent Office

A Sensation in the World of Advertising

Receives Market Reports, Current Events, News Items,
Lectures and Entertainment from Famous Broadcasting Stations

COAST TO COAST

And Flashes Your ADVERTISING

“BROADCAST”

With Force and Dignity

**ESPECIALLY ADAPTED TO INDOOR OR OUTDOOR
ADVERTISING OR THE HOME BEAUTIFUL**

Name, Construction and Design
Protected by Patents Pending

For Proposition to The Trade, Write or Wire at Once

RADIO EQUIPMENT SERVICE

National Distributors

500 Fifth Avenue, New York City

200-Page Radio Catalog Ready !!

Illustrated by photographs, drawings and hook-up charts, showing a most complete line of radio telephone and telegraph equipment.

Have a copy available before you are flooded with Fall business.

Morscan Radio Co.
196 Market Street, Newark, N. J.

Morscan Radio Co.,
Newark, N. J.

Enclosed find ^{Check}
_{Money Order} for 50 cents for one copy of your new manual and catalogue of wireless telephone and telegraph parts, Fall and Winter issue, 1922-1923.

This 50 cents is to be rebated on initial \$10 order.

Name

Firm

Street

City State

Now Ready!
The DICTOGRAPH
 Radio Loud Speaker

THE radio public has been waiting for this Loud Speaker for the home—the *Dictograph Radio Loud Speaker!* From the first announcement of its development, popular interest has run high.

Here at last is the Radio Loud Speaker that meets the demands of the home. Here is the Loud Speaker built to Dictograph standards of supreme quality—that reproduces every sound clearly, naturally and in full volume, *without noise or distortion—and sold at a price within the reach of all!*

The great resources of Dictograph Products Corporation, its years of experience in making sound-transmission and Loud Speaking devices have made this wonderful Loud Speaker possible at such a low price. And the world-wide reputation of Dictograph products—the “Acousticon” for the Deaf, the Detective Dictograph, the Dictograph System of Loud-Speaking Telephones—has established an assured demand for this new Dictograph product.

Orders have been received in such volume, *in advance of production*, that we have been able to increase output and to reduce the price originally announced. Instead of \$25 the list price is now only \$20—complete with five ft. flexible cord.

Take advantage of the tremendous, waiting market for the Dictograph Radio Loud Speaker for the home! Will give splendid results in any vacuum tube set. Build big and **PERMANENT PROFITS** on the world-famous Dictograph name.

Protect yourself on delivery **NOW**. Get your order in quick! Wire your jobber or communicate direct for names of authorized distributors.

The Standard of the World



3000 ohms

Price
\$12

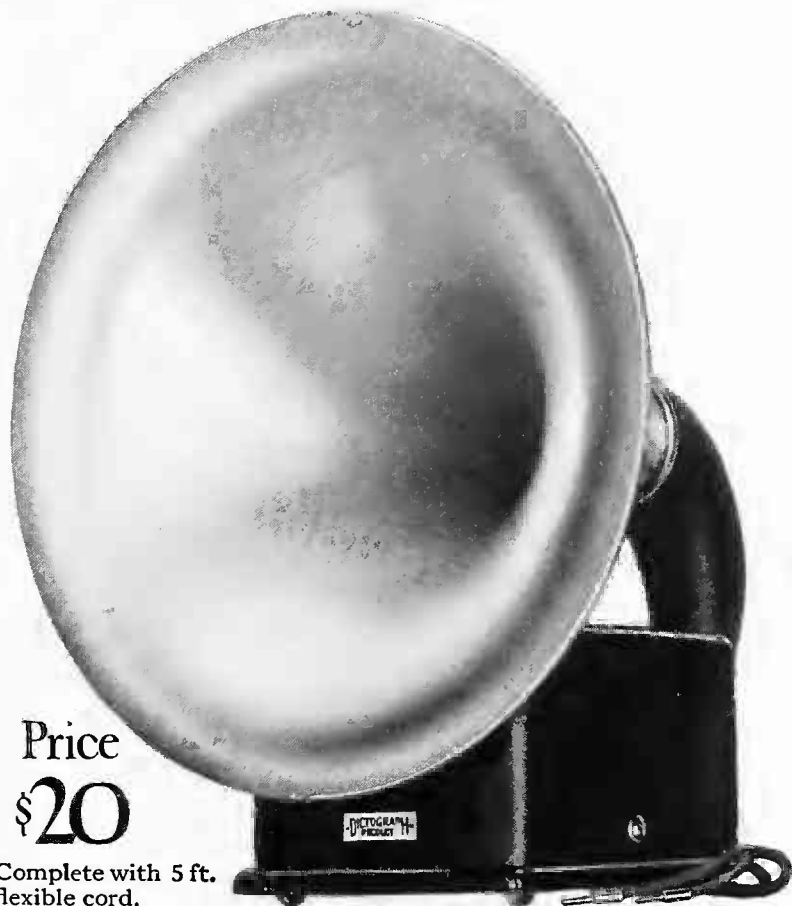

Price
\$20

Complete with 5 ft. flexible cord.

Cabinet of solid hardwood, ebony-finish, mounted upon rubber knobs. The eleven-inch horn is of burnished copper attached to die cast black enamel tone arm, finished with nickel trimmings.

Note: Electrotypes of Loud Speaker and Head Set are available for catalogs, etc., and will be furnished on request.

DICTOGRAPH *Radio* HEAD SET

A sensational success! Constantly increasing sales by dealers everywhere prove the recognition by the radio public of Dictograph supreme quality. Get your share of the demand for the Dictograph—list price \$12—the best Head Set in the world regardless of price.

DICTOGRAPH PRODUCTS CORPORATION

220 WEST 42d STREET

Branches in all principal cities

NEW YORK CITY

STIMULATE FALL SALES



Everything Needed to Stock Your Store

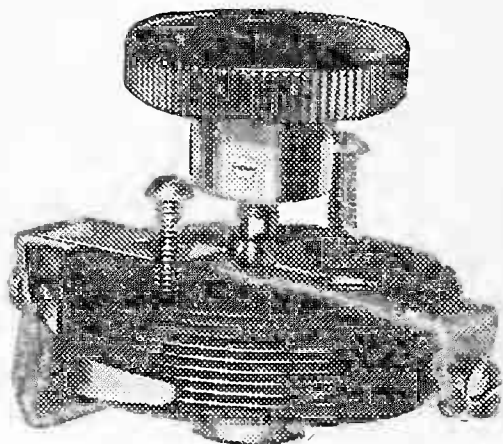

JENKINS RHEOSTAT

Vernier Throughout—2 Amps.—12 Ohms. Automatic Cut-out Switch in Knob makes exceptionally fine adjustment possible.

List\$1.75

RADIOMETER
VARIOCOUPERS
HEADSETS
VERNIER RHEOSTATS
PHONE CONDENSERS
GRID CONDENSERS

Other Specialties:
SOCKETS
COMPLETE SETS
CONDENSERS
RHEOSTATS
POTENTIOMETER
VARIOMETERS

DIALS
PLUGS
TUBES
SWITCH LEVERS
SPAGHETTI
ETC.

Discounts
35%
To
50%

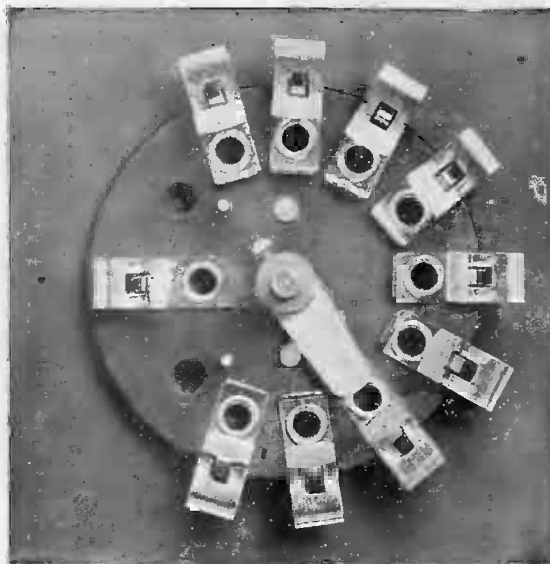

Drisco Panel Switch completely eliminates drilling of countless holes for switch points, and also does away with soldering connections. Complete with Switch Arm, Knob and Dial.

List\$1.00

Write for Descriptive Catalogue

HAROLD M. SCHWAB, Inc.

SOLE DISTRIBUTOR OF DRISCO PRODUCTS

419 WEST 42nd STREET, NEW YORK CITY

The Montclair Standard

The Aristocrat of Vacuum Tube Receiving Sets

Since 1909, the designers and engineer of this organization have been following closely the march of progress of Wireless Telephony and Telegraphy. Recently they decided to offer to the trade a compact, efficient, and aristocratic Receiving and Detector Unit in a single cabinet. It is, undoubtedly, the smallest Vacuum Tube Receiving Set manufactured for re-sale.



Much material and experimental work was required before we could give the public a Receiving Set that would be suitable for reasonable wave-ranges and distance, and still maintain loudness for which all seek.

List \$35.00

Special proposition to jobbers

We are proud to offer to you the Montclair Standard.

From the Quartered Oak Cabinet to the special small Battery, every detail has been carefully observed; therefore we know that in placing this Receiving Set on the market we can unqualifiedly guarantee its performance as well as workmanship.

Montclair Radio Manufacturing Corporation

Sales Office: 657 BLOOMFIELD AVE., MONTCLAIR, N. J.

NEW YORK COIL COMPANY RADIO PRODUCTS ARE BUILT TO WORK—NOT JUST TO SELL

THE LEADERSHIP THEY ENJOY IS DUE TO CORRECT DESIGN, EXCEPTIONAL WORKMANSHIP AND EIGHTEEN YEARS' EXPERIENCE IN THE MANUFACTURE OF WIRELESS AND PRECISION ELECTRICAL DEVICES. TWO ESPECIALLY EQUIPPED FACTORIES IN QUANTITY PRODUCTION ARE RESPONSIBLE FOR OUR LOW PRICES AND EXTREME POPULARITY WITH THE JOBBER AND DEALER.

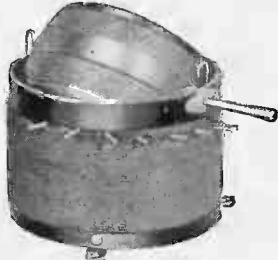

Price, \$1.00

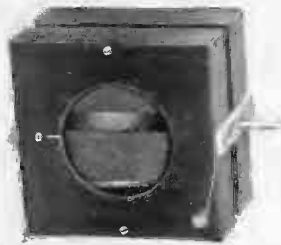

Price, \$4.00

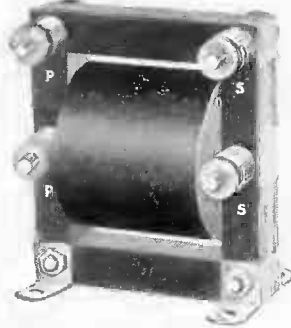

Price, \$4.00

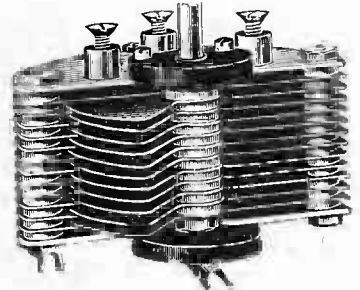

11 plate, price..... \$1.50
23 plate, price..... 2.00
43 plate, price..... 3.00
3 plate veneer..... 1.25



Mounted Vario-coupler for panel or table use,—but three holes in panel saves all laying out, drilling and soldering—nothing else like it. Price, \$8.00.



Entertain-a-phone Receiving Set No. 2 detector and two stages amplification. Price, \$50.00. Greatest value in Radio.

NEW YORK COIL COMPANY, Inc.
338 Pearl Street New York City, N.Y.

VARIO COUPLER

VARIOMETER

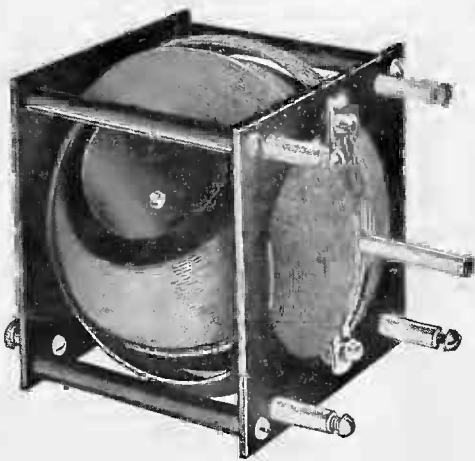

Unique in Design—Efficient in Operation

List Price - - - \$4.50

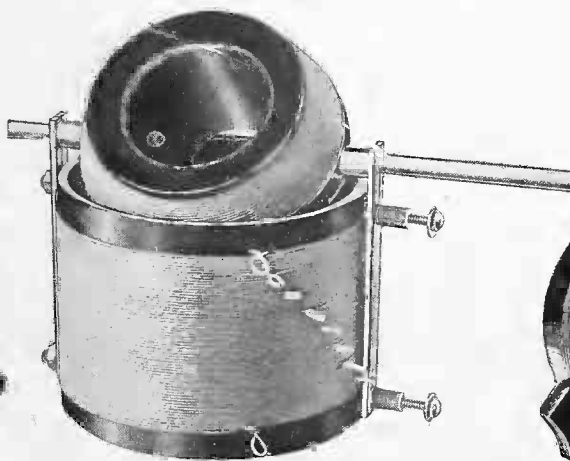

List Price - - - \$3.50

Dealers and Jobbers Write for Particulars

SHORT WAVE UNIT

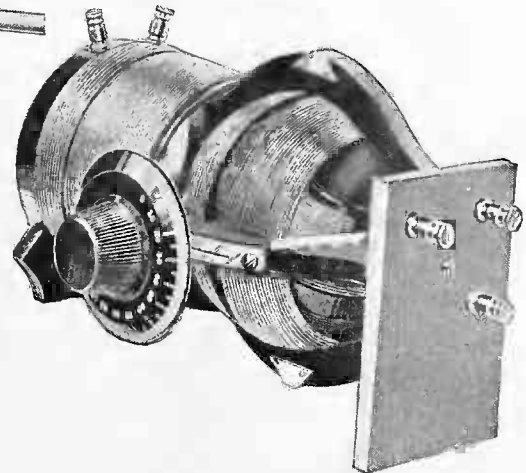

An Exclusive Utility Combination

List Price - - - \$10.00

NELSON RADIO PARTS CO.

89 ACADEMY STREET,

NEWARK, N. J.

Let Our Free Service Bureau Help You Supply Your Needs

Tell us your needs and we'll put you in touch with reputable firms to the end that you will receive information on the latest and best equipment. A post card will do or use the coupon below.

- | | | | | |
|--------------------------|---------------------------|---------------------------|----------------------------|--------------------------|
| A | 62 Condensers, mica | I | 182 Patent wire | 238 Switches |
| 1 "A" Batteries | 63 Condensers, loading | 126 Indicators | 183 Patent wire terminals | 239 Switch levers |
| 2 Aerials | 64 Connection blocks | 127 Inductances, C. W. | 184 Plans | 240 Switch points |
| 3 Aerial wire | 77 Contract work | Transmitting | 185 Phonograph attach- | 241 Symbols |
| 4 Aerial protectors | 65 Control panels | 128 Insulators | ments | |
| 5 Aerial switches | 66 Condenser parts | 129 Insulation | 186 Plate condensers | T |
| 6 Aerial insulators | 67 Copper wire | 130 Invention develop- | 187 Porcelain | 246 Tapes |
| 7 Aerials, loop | 68 Cords | ments | 188 Porcelain cleats | 247 Telephone cord |
| 8 Air condensers | 69 Cord tips | | 189 Porcelain insulators | 248 Telephone plugs |
| 9 Adapters | 70 Crystals | J | 190 Porcelain mountings | 249 Telephone receivers |
| 10 Amplifiers | 71 Crystal detector units | 131 Jacks | 191 Porcelain tubes | 250 Telegraph keys |
| 11 Amplifying units | 72 Crystal receiving sets | K | 192 Porcelain V. T. recep- | 251 Telegraph teachers |
| 12 Aluminum wire | 73 C. W. Transmitter | 132 Knock down units | acles | 252 Testing instruments |
| 13 Ammeters | sets | | 193 Porcelain V. T. sock- | 253 Testing clips |
| 14 Amplifying tubes | 74 C. W. Filament heat- | L | ets | 254 Terminals |
| 15 Amplifying horns | ed transformers | 136 Lead-in wire | 194 Precision instruments | 255 Thermometers |
| 16 Amplifying transform- | 75 C. W. Inductances | 137 Lead-in switches | 195 Polarity indicators | 256 Tools |
| ers | 76 C. W. Power trans- | 138 Lead-in bushings | 196 Plate connectors | 257 Trade marks |
| 17 Antennae, cage | formers | 139 Lead-in insulators | 197 Paste solder | 258 Transformers |
| 20 Antenna light wire | | 140 Levers, Switch | 198 Phosphor-bronze wire | 259 Transmitters |
| plugs | D | 141 Lightning arrestors | sheets | 260 Transmitting sets |
| 18 Audio frequency | 81 Detectors | 142 Lightning switches | Q | 261 Towers |
| transformers | 82 Detector panels | 143 Loading coils | 307 Quenching spark gaps | 262 Three coil mounting |
| 19 Automatic transmit- | 83 Detector tubes | 144 Loading inductance | | 263 Tin foil |
| ters | 84 Detector minerals | 145 Loose couplers | R | 264 Tuning coils |
| | 85 Detector units | 146 Loud speakers | 308 Radio books | 265 Tubes, amplifier |
| B | 86 Dictionary, Radio | 147 Locked lever switches | 309 Radio schools | 266 Tubes, detector |
| 21 "B" Batteries | 87 Dials | 148 Lock nuts | 310 Radio publications | 267 Tubing, flexible |
| 22 Batteries, "A" | 88 Dial switches | 149 Loop aerials | 199 Radio frequency | 268 Tube sockets |
| 23 Batteries, dry | 89 Drawings | 150 Lugs | transformers | 269 Tubes |
| 24 Batteries, storage | 90 Diagrams | | 200 Reactor, plate circuit | 270 Tuner and detector |
| 25 Battery chemicals | E | M | 201 Reactor, filter | cabinets |
| 26 Battery chargers | 91 End mountings | 313 Mailing lists | 202 Receiving sets | 271 Two stage cabinets |
| 27 Battery testing in- | (tubes) | 314 Metals | 203 Receiving head sets | 272 Two stage amplifier |
| struments | 92 Engraving | 151 Magnetic modulator | 204 Receiving transfor- | unit |
| 28 Battery switches | 93 Electrotypes | 152 Modulation transfor- | mers | U |
| 29 Battery rheostats | | mers | 205 Receptors | 276 Unit type receiving |
| 30 Battery clips | F | 153 Machine screws | 206 Receiver magnets | sets |
| 31 Battery handles | 95 Fibre spools | 154 Magnet wire | 207 Rectifiers | 277 Unassembled sets |
| 32 Battery potentiom- | 96 Fan switches | 155 Magazines, Radio | 208 Rectifying tubes | |
| eters | 97 Filter reactors | 156 Mica | 209 Regenerative sets | V |
| 33 Binding posts | 98 Fixed condensers | 157 Mica diaphragms | 210 Rheostats | 281 Vacuum tubes |
| 34 Books | 99 Fire extinguishers | 158 Mica condensers | 211 Rheostat wire | 282 Vacuum tube sockets |
| 35 Boxes | 100 Filament rheostat | 159 Mica diaphragm trans- | 212 Rods | 283 Variable condensers |
| 36 Brass parts | 101 Filter coils | formers | 213 Rotary lever switches | 284 Variometers |
| 37 Bushings | 102 Flashlights | 160 Microphone transfor- | 214 Rotary spark gaps | 285 Vario couplers |
| 38 Buzzers | 103 Fuse terminals | mers | 215 Rotary variable con- | 286 Variable grid leak |
| | | 161 Milliammeters | densers | 287 Vernier adjusters |
| C | | 162 Milli-voltmeters | 216 Rubber parts | 288 Vibrators |
| 41 Cabinets | G | 163 Motors | 217 Rotors | 289 Vocalouds |
| 42 Cam switches | 106 Gaps, Spark | 164 Motor generators | S | 290 Voltmeters |
| 43 Carbon potentiomet- | 107 Generators | 165 Mounting coils | 221 Safety switches | 291 Vulcanized fibre |
| ers | 108 Glass | 166 Minerals | 222 Safety fuses | sheets |
| 44 Change-over switches | 109 Grid condensers | 167 Mountings | 223 Sliders and rods | 292 V. T. receiving sets |
| 45 Charging rectifiers | 110 Grid leaks | | 224 Sockets | 293 Variogrid leak |
| 46 Choke coils | 109 Grid leaks | N | 225 Soft metal | 294 V. T. detector units |
| 47 Cat whiskers | 110 Grid leaks, variable | 171 Name plates | 226 Shielded dials | 295 V. T. control units |
| 48 Cap nuts | 111 Grid coils | 172 Nickel parts | 227 Short wave sets | 296 V. T. receptacle |
| 49 Carbon walls | 112 Ground clamps | 173 Nuts | 228 Solder | |
| 50 Cardboard tubes | 113 Ground wires | O | 229 Solder, bar | W |
| 78 Charts | 114 Ground switches | 176 One stage amplifier | 312 Soldering irons (elec- | 297 Washers |
| 51 Chopper, rotary | | units | tric) | 298 Watch case receivers |
| 52 Clamps | H | 177 Oscillation transfor- | 230 Spark transformers | 299 Wattmeters |
| 53 Clips | 116 Headsets and bands | mers | 231 Spark coil selectors | 300 Wavemeters |
| 54 Coils | 117 Honeycomb coils | P | 232 Spaghetti tubing | 301 Wave tuner |
| 55 Coil mountings | 118 Honeycomb moun- | 178 Panels | 233 Special apparatus | 302 Wire |
| 56 Coil plugs | tings | 179 Panel plugs | 234 Spark gaps | 303 Wire, aerial |
| 57 Coils, spark | 119 Honeycomb plugs | 180 Panel controls | 235 Spring clips | 304 Wire phosphor bronze |
| 58 Condensers | 120 Hook switches | 181 Paper tubes | 236 Storage batteries | 305 Wire, copper clad |
| 59 Condensers, fixed | 121 Horns | 311 Patent registration | 237 Sectional receiving | 306 Wire, magnet |
| 60 Condensers, variable | 122 Hydrometers | | sets | |
| 61 Condensers, air | | | | |

Note the number of the item you want to buy—then check the corresponding number in the coupon below and mail to us.

TEAR OFF HERE

1	2	3	4	5	6	7	8	9	10	11	12	13	14	15	16	17	18	19	20	21
22	23	24	25	26	27	28	29	30	31	32	33	34	35	36	37	38	39	40	41	42
43	44	45	46	47	48	49	50	51	52	53	54	55	56	57	58	59	60	61	62	63
64	65	66	67	68	69	70	71	72	73	74	75	76	77	78	79	80	81	82	83	84
85	86	87	88	89	90	91	92	93	94	95	96	97	98	99	100	101	102	103	104	105
106	107	108	109	110	111	112	113	114	115	116	117	118	119	120	121	122	123	124	125	126
127	128	129	130	131	132	133	134	135	136	137	138	139	140	141	142	143	144	145	146	147
148	149	150	151	152	153	154	155	156	157	158	159	160	161	162	163	164	165	166	167	168
169	170	171	172	173	174	175	176	177	178	179	180	181	182	183	184	185	186	187	188	189
190	191	192	193	194	195	196	197	198	199	200	201	202	203	204	205	206	207	208	209	210
211	212	213	214	215	216	217	218	219	220	221	222	223	224	225	226	227	228	229	230	231
232	233	234	235	236	237	238	239	240	241	242	243	244	245	246	247	248	249	250	251	252
253	254	255	256	257	258	259	260	261	262	263	264	265	266	267	268	269	270	271	272	273
274	275	276	277	278	279	280	281	282	283	284	285	286	287	288	289	290	291	292	293	294
295	296	297	298	299	300	301	302	303	304	305	306	307	308	309	310	311	312	313	314	315

Service Bureau The Radio Dealer,
1133 Broadway, New York City.

We are interested in buying radio equipment and have circled the numbers on this coupon of the items we are ready to buy now. Please have manufacturers of these lines quote us dealers' prices.

Name

Address

We are
—Retailers
—Jobbers
—Manufacturers



THE RADIO
TRADE MARK
OF QUALITY



VICT-RA-PHONE
 CONSOLE TABLE

WE manufacture a complete line of Radio Sets and Parts consisting of:
 Complete Receiving Sets, Tuners,
 Tuners and Detectors, Tuner, Detector and Two-Stage Amplifiers,
 Tuner, Detector and Three-Stage Amplifiers, Detector Units,
 Detector and Two-Stage Amplifiers,
 Single-Stage Amplifiers, Two-Stage Amplifiers,
 Variometers, Variocouplers,
 V. T. Sockets, Rheostats,
 Grid Condensers, Plate Condensers,
 Variable Condensers, Knobs, Dials, Binding Posts, Etc.

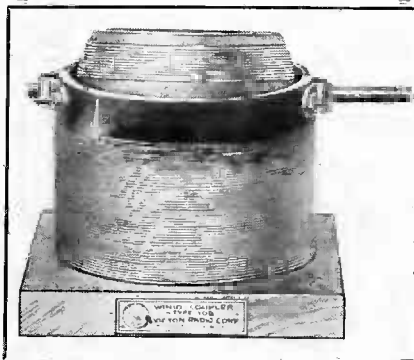

VARIOCOUPLER
 TYPE 108

MR. JOBBER AND DEALER, DOES years of experience in manufacturing Radio Transmitting and Receiving Apparatus for **THE UNITED STATES GOVERNMENT** mean anything to you?

VICTOR engineers and workmen have had this experience and are capable of producing highly satisfactory Radio Apparatus.

OUR LINE of Receiving Sets and Parts is extensive—in fact we can supply you with practically all Radio requisites.

JOBBER AND DEALERS are invited to write us for complete information in regard to our attractive proposition.

CATALOGUE ISSUED ON REQUEST



TUNER, DETECTOR AND TWO-STAGE AMPLIFIER
 TYPE 115



VICTOR RADIO CORPORATION

799 East 135th Street, New York City

Manufacturers of Complete Radio Sets and Parts

AMES RADIO PRODUCTS

Manufactured by Heinze Electric Company, one of New England's foremost and oldest electrical organizations. Noted for its skill, quality of workmanship and efficiency for nearly one quarter of a century.

All radio products bearing the Ames trade mark are manufactured complete by the Heinze Electric Company and distributed nationally exclusively by Picard Radio Corporation.

Each product is uniformly guaranteed and due to large production prices are generally lower than competing articles of similar quality.

Distributors, jobbers and manufacturers write Picard Radio Corporation, 16 West 46th Street, New York City, at once, for special discounts.

AMES Audio Frequency Transformer



Completely encased in non-magnetic metal, it is perfectly shielded.

Appearance and performance of the Ames Audio Transformer are second to none.

The round casing enables placing of the cores at right angles without detracting from the appearance of the set.

List price, \$5.00. Write for discounts

AMES Vario-Coupler

The appearance of this coupler alone is a guarantee of its salability.

Dealers everywhere pronounce it not only the best in appearance, but in performance.

All connections may be made without soldering if so desired. This is practically an exclusive feature.

Effective range 150-600 meters.

List price \$6.00.

Write for discounts.

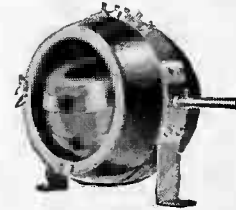

AMES Variable Condenser

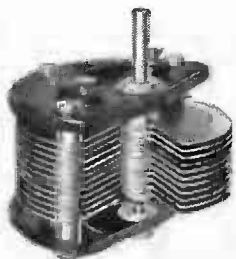

In this condenser special attention has been paid to accurate spacing of the plates and to rigidity of construction, which is achieved by our own patented brass enameled end mountings.

Thus the annoyance of "shorts" between plates has been practically eliminated as well as unequal variations in capacity.

All insulation is genuine *Micarta*.

11 plate, maximum capacity .00029 Mfd., list price. \$2.00
23 plate, maximum capacity .00036 Mfd., list price. 2.50
43 plate, maximum capacity .0008 Mfd., list price. 3.00

Write for discounts

Genuine Picardite Dials

"Fit any shaft"

A real man's size clean-cut dial with our exclusive inter-changeable center bushing of brass, made to fit either 3/16" or 1/4" shaft, thereby reducing the stock necessary to be carried by radio dealers.



Write for sample dial sent postpaid 25c.

List prices 2 1/2" size, \$0.60

3" size, .75

4" size, 1.00

Maximum discounts on minimum quantities

Sold only to recognized distributors, jobbers and manufacturers.

Distributed nationally only by

Picard Radio Corporation

16 West 46th St. New York

Musio

The Voice from the Air

\$12.50
Retail

Complete
Ear Phones
Excepted

36%
on the
Sale



56%
on the
Investment

*With the New
Musio Perfected
Crystal Detector
Found only in
Musio*

*With Antenna,
Ground Wire,
Ground Clamp,
Insulators, Tube,
Knobs and Connectors*

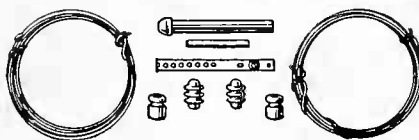

Sensation of the Radio Trade

Here's a new and bigger radio value. It is recognizable on sight and every one who sees it will say so. Everything about it—from its handsome

mahogany finish to the last mechanical detail—marks it as the radio receiving set that will set the standard of radio values for a long time to come.

Bigger Value—Greater Profits

In Musio you cannot only supply your trade with the greatest radio value yet offered, but you gain a fast selling item with a splendid

profit. Thousands of dealers will get behind Musio because it pays. It will soon be the most popular receiving set on the market.

Nationally Advertised

A great publicity campaign on Musio is about to begin. Over *ten million people* will read about Musio and the Musio Perfected Crystal Detector which helps make Musio

the equal of receiving sets at double and more the price. Be one of the first to stock Musio and the first to treat your trade with this rare value.

Enormous Sales—Get Your Share

There is hardly a home that can't afford Radio when it comes in such quality at so low a price. Sales will be enormous. There isn't a dealer who can afford not to stock Musio now in preparation of a big and prosperous radio winter. Musio with accessories comes packed to make a

display that spreads unprecedented value before the customer's eye and makes the sale quickly. Send for a sample Musio. If you are not surprised and pleased with it, return it, and get your credit. Every Musio is thoroughly tested and absolutely guaranteed.

Radio-Musio Co., Inc.
PITTSBURGH

RD-30 Nernst Bldg.
PENNSYLVANIA

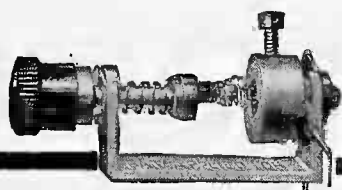

Musio Perfected Crystal Detector
Pat. Pend.

CRYSTALS

OF THE BETTER KIND

*Radiophone
Tested*

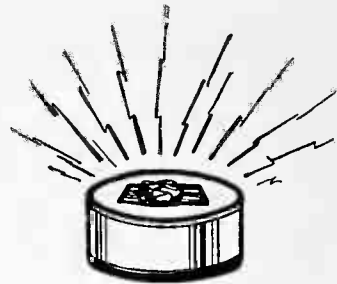

*Quality
Guaranteed*

GOLDITE—GALENA—SILICON

PACKED IN NEAT INDIVIDUAL CONTAINERS

Price 6c for either Mounted or Unmounted in lots of 1000; combination shipments if desired. Made up with your own advertisement upon request.

J. F. BISHOP & COMPANY

Telephone Market 2236

91-93 MADISON ST., NEWARK, N. J.

MICA RADIO INSULATION

Keeps Customers Coming for More

EMPIRE OILED TUBING (CALLED SPAGHETTI)

Amateurs who buy Empire Spaghetti Tubing from you will come back for more. Unsurpassed in insulating qualities and has great dielectric strength. Very flexible, durable and smooth. Right angle turns easily made. Supplied in yellow, black and other colors in all radio sizes, 36 inch lengths. Be sure to get the genuine "Empire."

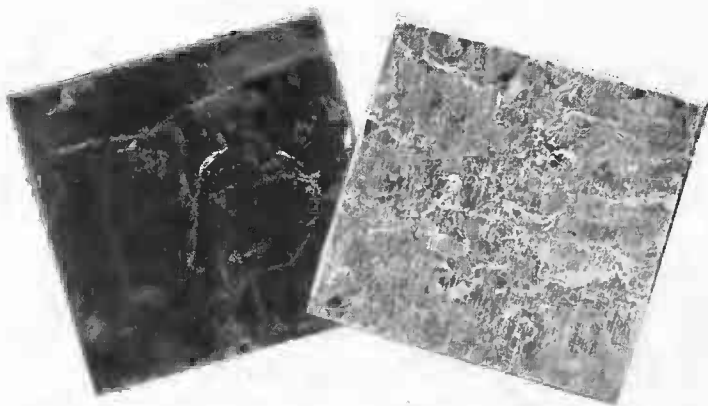

MICANITE PANELS

Every experimenter will want to try this remarkable insulating material, proved by years of use in the electrical industry and employed by professional radio operators. Made in sheets 36 inches square and in various thicknesses for various purposes, or supplied as washers, tubes, rings, etc. Samples or quotations on request.

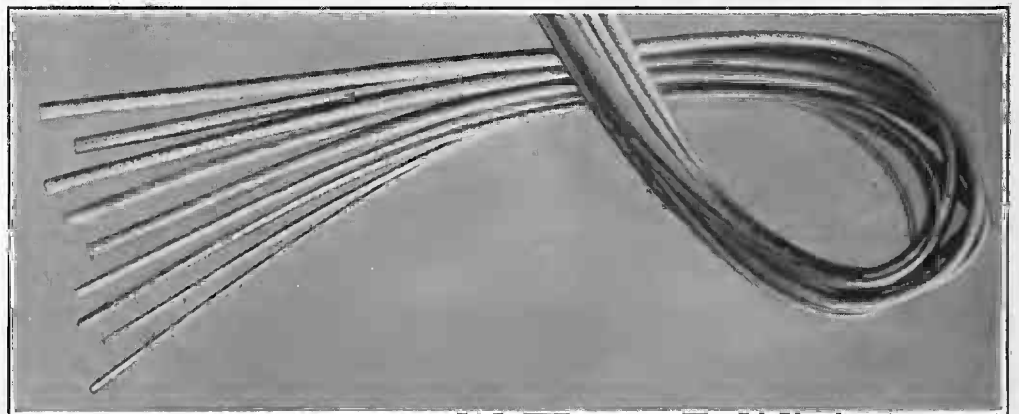

2018-F

MICA INSULATOR COMPANY

68 Church Street, New York.

542 So. Dearborn Street, Chicago.

Works: Schenectady, N. Y.

Agencies—Monroe Brass & Wire Co., Cincinnati; G. Arthur Morrell, Cleveland; Electrical Specialty Co., San Francisco and Los Angeles

INTERNATIONAL AND ANNUAL

CHICAGO RADIO SHOW

AT THE COLISEUM CHICAGO ILLINOIS

SATURDAY TO SATURDAY
OCT. 14TH TO OCT. 21ST



THE PUBLIC WILL MEET THE MANUFACTURER THE PUBLIC WILL MEET

IN THE LARGEST STREET-FLOOR EXPOSITION BUILDING IN THE UNITED STATES

A COMPREHENSIVE PROSPECTUS NOW READY. WRITE FOR IT.

BUSINESS OFFICE 549 McCORMICK BLDG. PHONE WABASH 1844

MR. DEALER

How many of these sets equipped with phones can you use at \$12.75 each net?

1500 ohm "Royal-fone"

Five foot cord

Tungsten Steel magnets

Norway iron pole pieces

Adjustable head band

Every phone guaranteed

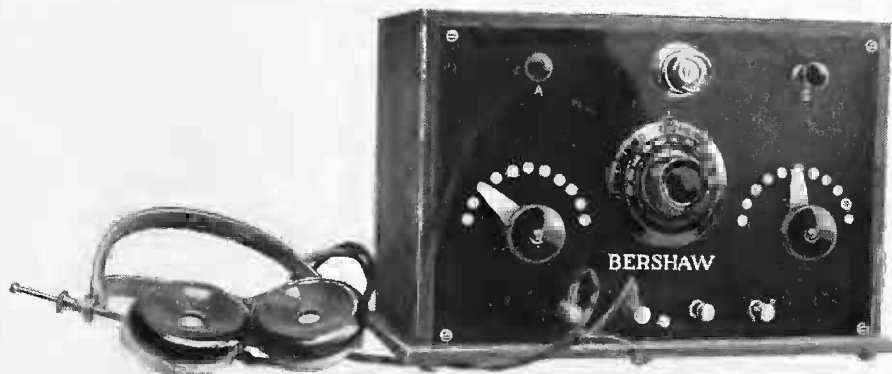

7 3/4" x 11" x 5 1/8"

Grewol detector

Vario coupler

Primary and secondary taps

All connections soldered

Bakelite panel 7" x 10 1/2"

Cabinet sturdy and well finished

We can make immediate shipments
It is the biggest selling event in Radio history
It can retail at \$25.00 to \$35.00
You can set your own selling price
Let us send you one C.O.D. on trial

BERSHAW RADIO & MFG. CO., 82 Barclay St., Newark, N. J.



THE "NORTH STAR" RECEIVER—Type 1-GR
(Regenerative)

Designed and developed by experienced Radio Engineers for those who demand modern radio apparatus of high efficiency and scientific construction. This Type 1-GR Receiver is the best to be had. Our method of assembling the various units assures perfection in operation. The cabinet is made of hand polished walnut. The panel and dials are of the very best grade of bakelite. The variometers and variocoupler are Atwater-Kent. All connections to the set are made through the rear of the cabinet, thus concealing all unsightly wiring. The wave length is 150 to 650 meters. Regeneration is perfect on all wave lengths.

At our Minneapolis, Minnesota, station, with a 70 foot, two wire antenna, we are able to hear wireless 'phone concerts sent out by the following stations, plainly and distinctly:

Atlanta, Georgia.

Detroit, Michigan.

Pittsburgh, Pennsylvania.

Denver, Colorado.

Kansas City, Missouri

Cincinnati, Ohio.

Schenectady, New York.

PRICE, WITHOUT TUBE, PHONES OR BATTERIES:

\$57.50

PRICE, COMPLETE WITH EQUIPMENT, AS FOLLOWS, READY TO INSTALL:

1 Radiotron UV 200 Tube. 1 Novo "B" Battery. 1 Aerial. 1 Pair 2000 ohm Frost Phones. 1 Grant 80 Ampere Storage Battery

\$78.50

THE "NORTH STAR" TWO STAGE AMPLIFIER—Type 2-GA

Designed and developed to match the above Type 1-GR receiver. By means of this amplifier and the above receiver all of the larger broadcasting stations in the United States are heard at our Minneapolis, Minnesota, station, with sufficient volume for use with a Type R-3 Magnavox. With this outfit concerts broadcast from Atlanta Journal, Atlanta, Georgia; Detroit News, Detroit, Michigan, and the Sweeney School, Kansas City, Missouri, are heard plainly and distinctly throughout the entire building.

PRICE, WITHOUT TUBES OR BATTERIES:

\$50.00

DEALERS:
WRITE OR
WIRE FOR
SAMPLES.

WE CAN OFFER YOU ATTRACTIVE DISCOUNTS, MAKE IMMEDIATE DELIVERIES, GIVE YOU *EXCLUSIVE* TERRITORY, and FURNISH YOU WITH AN INSTRUMENT THAT WILL BOTH SELL AND SATISFY.

MINNESOTA RADIO SALES CORPORATION

Manufacturers

512 PALACE BUILDING

MINNEAPOLIS, MINNESOTA, U. S. A.

1500 Ohms
\$5.00 List



2200 Ohms
\$7.50 List



"Hello Everybody

You can hear me, can't you?
You are listening thru a 'Royalfone,'
King of all. You can connect me
To any set and hear very clearly.
I am sensitive and sturdy. When
I am on your head you do not
Know I am there. I know you
Will like me. Most any radio
Dealer knows me and will tell
You more about me. You can
Get me at either \$5.00 or \$7.50 depending
On your pocket. I am guaranteed, too.
Until we meet again, Good Bye."

"ROYALFONE," *King of All.*

MR. JOBBER: Get in on this wonderful phone.
Let us send you some literature. We only sell to
jobbers thru our sales force, and our discounts are
attractive. We supply circulars, window displays,
counter cards, pasters, specialties, and electros.
Watch for our ads in the leading radio publications.
We make immediate shipments.

ROYAL ELECTRICAL LABORATORIES
MANUFACTURERS OF
Electrical and Radio Equipment

207 Market St., Newark, N. J.

Royalfone

Gilbert Radio Apparatus



No. 4023

RADIO FREQUENCY

Long Distance Receiving—Splendid Tone Quality

For long distance receiving and splendid tone quality this new Radio Frequency Set is unrivalled at anywhere near the price. It is based on the wonderful principle of Radio Frequency Amplification, the highest type of receiving set yet produced.

This and other outfits together with a number of the most advanced radio parts go to make up the Gilbert Line—a line of good, serviceable radio apparatus, efficient and at the same time priced to meet the popular demand—with good profit to yourself.

Send for catalog No. 54 illustrating and describing this new Radio Frequency Set with all other Gilbert Radio Apparatus.

THE A. C. GILBERT COMPANY

DEPT. C

NEW HAVEN, CONN.

In Canada: The A. C. Gilbert Menzies Co., Ltd., Toronto

THE RADIO DEALER

The Radio Trade Journal
For The Radio Retailer

CONTENTS SEPTEMBER, 1922

SPECIAL ARTICLES

A Song Well Sung.....	By L. N. Allen	107
A Valuable Form of Advertising.....	By Anderson Dwight	40
Better Detectors.....	By C. C. Culin	73
Concerning Canned Music Now Broadcasted.....	By George H. Fischer	34
German Radio Apparatus Industry.....	By N. B. Davis	111
Interviewing Marshall Beymer.....	By N. Beesey	48
Many Important Details in Manufacturing Phones.....	By Chas. H. Lehman	35
Mica Diaphragms Minimize Phone Troubles.....	By R. P. Clarkson	44
More Business on a Smaller Investment.....	By R. H. Butler	33
Nominations for Head of Association.....	By Bernard J. Farrell	29
Offering Varied Parts.....	By Frederick W. Germer	110
Outlining Program for Fall Business.....	By J. McKerchar	32
Packing of Sets Important.....	By B. D. Browne	86
Radio Trade Unaffected by Inventions.....	By Joseph Frank	121
Territorial Limitations of Trade Marks.....	By Chauncey P. Carter	42
The Future of Radio.....	By Edw. J. Nally	121
The Radio Dealer an Important Factor.....	By H. G. Cisin	34
The Radio Situation.....	By E. F. Durkis	80
The Wave Antenna.....	By J. Bernard	66
Victra-Phone Console Cabinets for Radio.....	By Thomas J. Ryan	112
Who Owns This Name?.....	By Chauncey P. Carter	47
Wonderful Radio.....	By Edward G. Egloff	77
What Is a Jobber?.....	By John R. Hall	82

DEPARTMENTS

Editorial	36
Ideas for Live Wire Retailers.....	46
Philadelphia Pointers.....	94
Questions and Answers.....	83
Radio Securities.....	128
Trade Mark Department.....	87
What the Manufacturers Are Doing.....	72

THE RADIO DEALER, THE RADIO TRADE JOURNAL, published monthly on the first, at 1133 Broadway, New York, N. Y., by THE RADIO DEALER COMPANY, in the interest of dealers in Radio Supplies. HARRY M. KONWISER, Publisher; LAURENCE A. NIXON, Managing Editor; JOHN L. SIMMONS and BERNARD J. FARRELL, Editors; A. L. KONWISER, B.S., Technical Editor; N. B. ZIMMERMAN, BERNARD FREEDMAN and EUGENE J. SCANLON, Associates; R. DESRAU, Circulation Manager; M. JAY KLEIN, Research Manager; B. B. STERN, Manager Service Bureau.

REPRESENTATIVES IN THE TRADE: ELMER W. MOORE, JOHN R. HALL, H. E. BENNETT, WM. B. WILKINSON, JR., J. MAURICE CASPER, J. A. DOUCET, H. L. KRENZ, M. A. CLARK, C. L. GEESEY, S. A. FRANK, C. M. MINIER, M. P. MCNEELEY, W. H. OKE, C. B. CABANISS, R. C. HULL.

PUBLICATION OFFICE
1133 Broadway, New York, N. Y.
Telephone Watkins 8926-8927

PITTSBURGH
Suite 570, Union Arcade, Pittsburgh, Penna.
PACIFIC COAST
Suite 510, 456 S. Spring St., Los Angeles, Calif.
Telephone Los Angeles 12052

CENTRAL STATES
35 South Dearborn Street, Chicago, Ill.
Telephone Dearborn 4053

SOUTHERN STATES
730 Gravier Street, New Orleans, La.

CANADIAN OFFICE
23 Lily Street, Winnipeg, Manitoba

NEW JERSEY
845 Broad Street, Newark, N. J.
Telephone Market 4659

Advertising Rates and detailed statement of circulation and other information for advertisers furnished on application. Advertising forms close the 15th of the month prior to date of issue.

Circulation restricted to manufacturers, jobbers and retailers in wireless equipment. Subscription in the United States, one dollar the year, payable invariably in advance. Subscription in foreign countries, two dollars the year, payable invariably in advance.

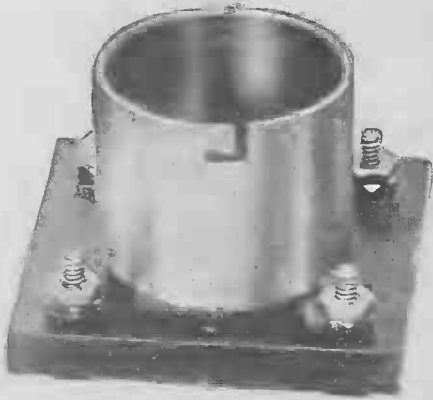

V. T. SOCKET
Type R104
Price, 85 cents

"RECO PRODUCTS"

PUT 'EM IN STOCK
AND WATCH 'EM MOVE

"Reco Products" Are Constructed of
the Best Materials Obtainable.

We Guarantee These Products and
Will Gladly Replace any Goods Which
Are Not to Your Satisfaction.

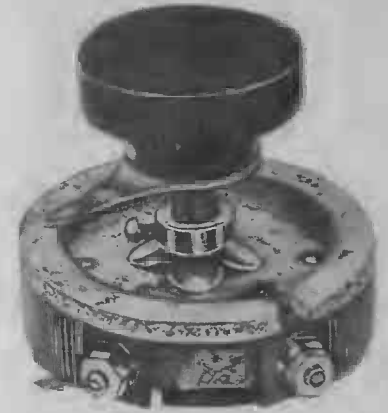

RHEOSTAT
Type R101
Price, \$1.00

*We Can Make
Prompt Deliveries*

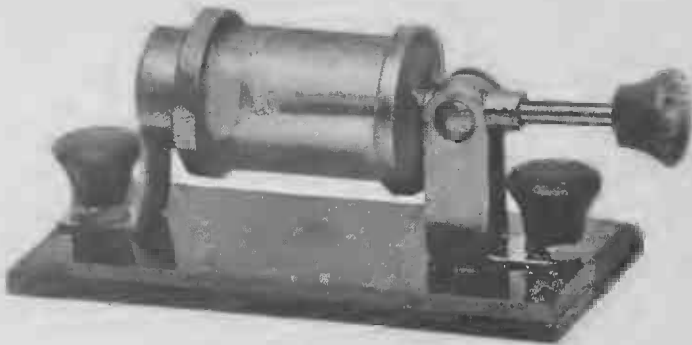

CRYSTAL DETECTOR
Type R102. Price, \$1.30

JOBBERS AND DEALERS

Are Invited to Wire or Write Us for Attractive
Proposition and Liberal Discounts. We Will
Gladly Submit Samples for Your Inspection.

RECO RADIO ENGINEERING CO.

16 UNION AVE.

NEW ROCHELLE, N. Y.

American Radio & Electric Co.

1133 BROADWAY

NEW YORK CITY

— — — — —
WRITE FOR OUR CATALOG
JUST OFF THE PRESS

The Radio Dealer

THE RADIO TRADE JOURNAL

Edited and Published at

1133 Broadway, New York, N. Y.

FOR THE RADIO RETAILER

VOL. 1. NO. 6

SEPTEMBER, 1922

ONE DOLLAR THE YEAR

Nominations Made For Head of Association

Full Staff of Officers of Radio Trade Association Will Be Elected at An Early Date

By BERNARD J. FARRELL

In response to nomination blanks sent out to members of THE RADIO TRADE ASSOCIATION a large number of nominations have been made for officials in this organization.

Officials to be elected are: President, Treasurer, Secretary, and seven Vice-Presidents as well as fifteen Directors. Over two hundred business men in this industry have been nominated for these various offices, due notice of which will be given to members of the association.

Membership applications continue to come in with a speed that promises the largest membership for this association of any organization in the radio field.

Dues of the organization, as voted during the week prior to publication of this article, will likely be one dollar. Due to the fact that the polls have not yet closed an exact figure as to votes received cannot be given.

Until the first meeting of the association no paid employees will be carried, nor will there be any pay roll or other expenses for the association. Postage and perhaps some small items for job printing, membership blanks, etc., will cover the cost of operation of the association until such time as the members can get together and elect a paid secretary, etc.

All stenographic work will be handled by the regular force of THE RADIO DEALER. No charge for quarters or other office expenses will be made until such time as the association can establish its own offices in some other section with its own staff of employees.

Dealers, jobbers and manufacturers reading this article are urged to fill in the blank that appears on this page, mailing it to THE RADIO TRADE ASSOCIATION, 1133 Broadway, New York, City.

USE THIS COUPON TO JOIN

THE RADIO TRADE ASSOCIATION

THE RADIO DEALER,

1133 Broadway,
New York City.

Please count us in as charter members of

THE RADIO TRADE ASSOCIATION

and send us all bulletins regarding same as they are issued.

We are jobbers . . . , retailers . . . , manufacturers . . . of radio equipment.

Name

Town

State

Date

Why Is a Distributor In The Radio Industry?

Being a Tale of How a Radio Jobber Is Improperly Made In These Stirring Days of Radio Activities

By HAROLD M. SCHWAB

The time—February. The year—1922. The place—any fair sized American city of usual progressiveness. Cast of characters include: Butchers, bakers, cloak and suit manufacturers, milliners, piano teachers, and last of all electricians and radio men.

Richard Doe, to be classified as any one of the above characters except the last two, reads in the newspapers day after day of the wonderful growth of the radio industry. Riding about town in a jitney bus he notices aerials appearing everywhere. Day by day he notices more and more red and white signs with the magic word radio appearing on them. He notices that behind most of these signs is a well filled shop, from which emerge from time to time customers, all carrying packages. The thought gradually grows that he, with experience for the past ten years in the novelty business, has the right to go into the radio, and besides his line, like most of others, is very slow and he sees a golden chance in this new industry.

Gradually this thought takes root and the outcome is an order to this printer for two hundred letter heads, envelopes and business cards, reading as follows:

RICHARD DOE & CO.,
Jobbers & Distributors of Radio
Supplies,
8864 Main Street,

Having thereby made himself a radio jobber he goes out to solicit business. It may be stated here that Mr. Doe is the proud owner of the Unicorn Art University Service Company, with desk room in a prominent office building in his town. He pays rent of \$15 a month and includes telephone service and two letters a day by the general office stenographer.

Supplies of all kinds are in great demand. The first store he visits asks if he can supply immediately 500 Crack Lightning Arresters as they need them at once and their regular jobber cannot fill their order. Richard assures them that he can, and with their written order in his pocket he rushes to the Crack Factory and presents his card. The sales manager eventually sees him and Richard explains that he has been in the radio

business for many years and is anxious to handle the Crack line. As an evidence of his good faith he will give them an order at once for 500 arresters, if they will make prompt delivery and give him a jobber's discount.

Mr. Sales Manager is far too busy a man to investigate Mr. Doe's statement, but an order is an order after all in his mind, and he accepts it and orders it filled immediately by depriving his regular jobbers of their weekly shipments in order to satisfy the newcomer. Mr. Doe then rushes uptown to his brother-in-law and tells him what he has done, explaining that he needs \$200 just for overnight in order to cover himself on this first order, which is being shipped C. O. D. He gets the money, giving note, receives the arresters and delivers them, making his profit with little or no expense.

The next day another dealer needs head sets. Mr. Doe rushes about to various manufacturers and distributors telling the same story of being in business for years and refers them to the Crack Lightning Arrester Company. Result, the same as in the Crack case. He gets his jobber's discount and fills or practically fills his orders and Mr. Doe, feeling himself established as a jobber after one week's business, takes a one inch space in three magazines and tells his story to the world. Richard Doe & Company, Distributors and Jobbers of Radio Supplies.

And thus we have a man accepted by manufacturers and magazines, doing business as a jobber with no earthly right to do so. He carries his office in his hat. He is his own general manager, salesman, shipping clerk and errand boy. He is here today, does business tomorrow, and is gone the next day. He creates havoc in the industry by cutting manufacturers' discounts. Through over expansion and a desire to grow into a million dollar concern over night he overbuys, ties up his capital and then unloads at a ridiculous price to save himself, thereby causing a tremendous downward rush in prices, on even staple merchandise, reaching the entire trade, that is caused by this cut of

price. He ties himself in many knots and finally goes bankrupt, leaving behind a list of down-hearted creditors, and causing throughout the entire industry a feeling of uncertainty and an attitude of indifference on the part of manufacturers to extend credit facilities to even substantial concerns.

It will be found upon investigation of the present conditions that nine out of ten of the failures are caused by over expansion and poor business policy. Something should be done in the industry to protect the legitimate distributor, carrying thousands of dollars worth of stock on his shelves, extending credit to his customers, traveling salesmen on the road and rendering real service to the trade at large in advertising, circularizing, etc. Protection is badly needed from the man who carries in stock only accepted merchandise for which he actually has orders, delivers everything C. O. D., extending no credit, travels no salesmen, and does the industry harm rather than good.

It is unfortunate that there is not a real organization for Radio jobbers with a branch for Radio dealers. So far, to the knowledge of the writer, the only organizations formed have been so called "paper" associations, more interested in obtaining a few dollars in dues with which to pay the salaries of the officers than in the well being and progress of the radio industry at large.

Personally it is felt that the ideal organization can only be really started by the jobbers and dealers themselves. No outside interests should enter into the organization or the handling of such an organization. Trade papers, fostering associations of this kind, would greatly benefit the entire industry. Through such an organization we might well take action against the present English embargo on American made radio supplies and demand of our representative in Congress retaliatory measures, protecting our industry from an influx of foreign radio merchandise. Through such an association, broadcasting schedules and expenses might well be regulated, and last but far from least, through such an organization the line between

(Continued on page 70)

Testing Radio Receiving Sets Important

Need in Trade for Tests That Will Give Better Information to Prospective Purchasers of Sets

By PAUL G. WEILER

Of Gregg and Company, Engineers, New York, N. Y.

While numerous tests have been developed to determine electrical characteristics of condensers, coils and other individual parts going to make up radio receivers, very little has been done so far toward testing complete receivers.

Most of the tests now in use are developed purely to serve the purposes of the technically trained. The results, expressed in highly scientific form, mean little or nothing to the average purchaser of radio equipment, whether he be an individual purchaser or a dealer.

Experience has shown that radio sets may vary in design and in the quality of their constituent parts more than any other scientific instrument. There are radio sets on the market today retailing at \$20.00 which will bring in broadcasting within a limited range quite well. Other sets costing as much as \$250.00 will give the purchaser probably more value for every dollar spent than the \$20.00 receiver. Yet, even a close inspection would reveal no difference in construction proportionate to the difference in price. Two receivers of similar design may vary tremendously in effectiveness according to details of construction which are not very conspicuous. Consequently, there is considerable confusion in the radio trade, and with the number of makes offered to the buyer increasing at a rapid pace, the situation is constantly becoming more bewildering. This condition makes the buyer suspect everything that is offered and creates a general impression that radio equipment is sold at any price the traffic will bear instead of being priced in accordance with cost of production and value given.

There is, therefore, a crying need for methods and facilities of testing and comparing receivers offered to the trade. As most of these receivers are used for broadcast reception, the tests applied should take into consideration especially those features which are recognized as most desirable in a broadcasting receiver and the results should be expressed

in such a way that even the less experienced might compare the testing certificates issued. These certificates could then be used as a basis for the valuation of different makes. If a larger number of manufacturers were to subscribe to such a service, it would give them a much more accurate idea of the comparative value of their own product.

The public probably values loud signals in a receiver more than any other quality. A good receiver used in connection with a horn or loud speaker should be as loud as the average phonograph, or nearly so. Therefore, tests should furnish information as to the comparative signal strength of the receiver. It is entirely feasible to obtain such data.

Curiosity on the part of the purchaser as to what distance he may be able to get should be satisfied so far as possible.

A familiar question of the purchaser in the metropolitan district is: "Will this receiver get Pittsburgh?" This question is difficult to answer definitely, as local conditions, the skill of the operator and certain conditions within the set which are not always under control may affect very considerably the range of a set. It is, however, entirely possible to ascertain the degree of sensitivity of any instrument in comparison with a given standard. This means, practically speaking, that if a set made by manufacturer "A" will bring in Pittsburgh in a certain location with some degree of reliability, any set rated better than "A" would give better results, and any set rated lower in sensitivity should not be relied upon to bring in far distant stations except under particularly favorable conditions.

Possibly the feature next in importance may be sharpness of tuning. Within the New York territory the question "Can you tune out the Navy Yard?" is common. The sharpness of tuning can be fairly well expressed in figures.

Another quality of sets is the trueness of reproduction or absence of distortion. While there is no

way of expressing this condition accurately in figures, certain characteristics of amplifying transformers together with other factors, will give a fairly good indication of the amount of distortion to be expected. These characteristics, in connection with actual comparison of tone qualities with a well designed standard, will give sufficient information for a pretty close rating of sets on this point.

There are some other points on which information would be desirable and may be had, but in the present status of the art, the four above mentioned are probably the most important and would give the trade necessary guidance in making purchases and fixing sales prices. A consistent application of standardized test methods would go very far toward bringing order out of the present chaos.

SCHWAB'S CATALOGUE

Six types of variable condensers ranging in prices from three to six dollars and featuring the new wire ring washer, giving perfect alignment, are listed under the Drisco line in the new catalogue recently issued by Harold M. Schwab, Inc., of 419 West 42nd Street, New York. This firm is the sole factory distributor for Drisco radio products.

Other Drisco specialties are the Drisco Radiometer designed to efficiently take the place of the conventional variocoupler; Drisco panel switches designed to eliminate the drilling of holes in the panel for contact points; potentiometers rheostats, series parallel switches, tuning coils, etc. The Drisco laboratories are equipped both for the assembly of radio equipment and other class of manufacturing such as die making, stamping, winding, screw machine work, etc.

Among other items listed in the Schwab catalogue are the Jenkins Vernier, Estru Lattice variometer and variocoupler, Planet loud speaker, and the Schwab brand of dials, sockets, switch levers and binding posts.

Outlining a Program for Fall Business

A Carefully Thought-out Sales Program and Strict Adherence to the Same Means Better and Larger Business

An exclusive interview with
M. F. CLIFFORD ESTEY

Gen. Sales Mgr. of Clapp-Eastham Co., by J. McKerchar

The cry throughout the radio industry at the present time is that the fall will see a big boom in radio. But is this true for every one connected with radio, regardless of the individual effort put forth by the many of the radio concerns? Doesn't the saying "You get out just as much as you put in and no more," apply to this business of radio? In a recent interview with F. Clifford Estey, general sales manager of the Clapp-Eastham Company of Cambridge, Mass., the answer to these queries was well answered. Mr. Estey is of the opinion that the fall will see a decided increase in business not because the so-called "summer static" is ebbing nor because the "folks are back in town" but rather because it has been generally advertised that good business is coming and everyone believing it, is planning to get a good share of it by carefully paving the way with a good sales program. The "summer slump" was a mental affliction suffered by a great many in the radio field and to a great many more the "fall boom" is but another such affliction. The "summer slump" was here only for those who slept while it passed. They will sleep through the fall "boom," too, for it will be here only for those who have taken care to put forth their best efforts to kill the much-advertised bugaboo the "summer slump," and who are now in a position to take care of the increased business that the fall will bring them as a class; an increase that will not be shared by those who were the drones during the summer months.

Probably the Clapp-Eastham Company is fortunate in that it has been manufacturing radio products exclusively for the past sixteen years. The company is in an enviable position in so far as its long experience is concerned and the many lessons they have learned regarding slumps and booms. Its preparation for fall business shows the touch of the master; a preparation that stands in contrast to the lack of preparation of many of the newcomers in the field.

The sales program of the Clapp-



M. F. CLIFFORD ESTEY

as General Sales Manager of the Clapp-Eastham Company is well informed on the radio situation. His advice in this article, to the trade in general, is worthy of the strictest attention.

He is a firm believer in the coming of "good times," but only after a period of hard work, followed by more hard work. He is strong for the hardworking conscientious dealer.

Eastham Company includes the territorial distribution of jobbers and a carefully planned advertising campaign to which the same jobbers and their respective dealers can attach their local sales plans. The program assures the Clapp-Eastham products an aggressive sales effort throughout the country. The company's advertising is already appearing in national, non-technical mediums, such as *The Saturday Evening Post* and *American Magazine*, and has penetrated the farm territory through the *Country Gentleman, Farm and Fire-*

side, Successful Farming and the *Farm Journal*. This advertising is in addition to that appearing in technical and trade journals and is of a directive nature, directing the consumer to his local dealer and the local dealer to his nearest Clapp-Eastham distributor.

The equipment that formerly went under the Clapp-Eastham name together with many new and important items, will appear in the future under the trade name of "Radak" which has already been disclosed. With this short, snappy and easy-to-be-remembered trade name, which is copyrighted, it is believed that the merchandising of the Clapp-Eastham apparatus will be made much easier for the thousands of dealers throughout the United States, who have carried the Clapp-Eastham line.

The company also keeps in intimate touch with its jobbers and dealers by distributing weekly sales letters containing usable information regarding the progress of the sales campaign as a whole and successful sales methods reported by jobbers and dealers in other parts of the country.

The result of this aid to jobbers and dealers is inevitable, a pleasant relationship between the Clapp-Eastham Company and its jobbers as well as the various dealers carrying the "Radak" line and also a resulting cooperation among all three classes,—the aim of all good business.

Such a plan as this, carefully thought out and then, strictly adhered to, means an increase in business that is not to be obtained by sitting back and awaiting booms and by advertising slumps. Only by keeping hard at it continually, can the men in the radio or any other field expect an uptrend of business. Many automobile concerns have shown that autos could be sold in the winter time but not until some progressive salesman backed by a progressive concern lead the way. The radio trade will get over its slump propaganda by everyone putting their shoulder to the wheel for bigger and better radio business.

More Business on a Smaller Investment

Turnover is as Important as Profit; Concentrate on Advertised, Fast-moving Stock; Phone Market Situation Discussed

By R. H. BUTLER

Merchandising Expert, Multiple Storage Battery Corp., of New York

The unprecedented growth of radio—from a small, struggling hobby of a few thousands to the daily necessity of millions, almost overnight—has been in many respects extremely harmful. No dealer needs or wants to be reminded of the utter impossibility of securing adequate stocks of established makes of radio merchandise from recognized producers. Irresponsible manufacturers were of course attracted by the scores and hundreds,—and most unfortunate of all, good dealers were forced to buy their unknown, unsatisfactory products for their own protection, to supply the insistent demands of their customers, and to hold their own against the new stores arising daily.

Let not this article be taken pessimistically, however. Nor should anyone think that the purpose is to disparage *all* the new concerns entering the industry. Some of them are responsible fair dealing concerns, who deserve to be ranked alongside of the old leaders. But at the same time, careful dealers must remember that these youngsters in radio cannot be as well known and respected as the old timers, and it is unwise to make the products of such concerns the backbone of your stock, unless the product is exceptionally meritorious, and is backed by a national advertising campaign sufficient to establish the necessary standing and prestige.

From personal contact with many of the established manufacturers in radio, the writer is familiar with the general trend of their plans. The information at hand clearly indicates that these concerns will this fall be fully able to take care of all legitimate dealers properly, and will keep a sufficient supply of reliable apparatus on the market to satisfy everyone.

In fact, the situation may very probably arise in a few months that the production of radio apparatus will considerably exceed the widest possible market. A recent investigation, covering over 80 important cities in the United States, made for a large producer of head phones revealed a startling situation. According to the most accurate fore-

casts of the plans of *all* the makers of head phones, their combined production will be between two and a quarter and two and a half million sets of phones *per year* starting this fall. Now head phones are not replaced every year by any means. The average life is approximately four or five years. On this basis, therefore, it means that ten million families must each buy one set of phones to keep up a demand for such a production. For reasons of means, location, inclination, etc., we certainly cannot expect to sell radio sets to one out of every two families in the country. It is quite obvious that a production of over two million sets of phones per year cannot possibly be met by the demand. A substantial proportion of the phones produced on this schedule will remain *unsold*.

The dealer's problem is in selecting the brands of phones he stocks. For one thing, it will not be necessary to order from half a dozen people in the hopes of getting delivery from one. It will be perfectly safe, and by far the most logical thing to do, to order only what you estimate your actual requirements to be, from the makers whose brands will sell easiest. Of course, by all means make this perfectly clear to the jobbers or manufacturers from whom you buy, and also place your order as far in advance as possible, specifying, if you prefer, future shipment dates.

Another important thing will be to keep your stocks down! *Not* by ordering small quantities of many brands, but by ordering larger quantities (at larger discounts, remember) of *fewer* makes. Three or four brands of head phones should be ample to complete a stock which includes different types of phones covering the complete price range. The idea that a "complete" stock must include every known make is one of the biggest faults with radio retailing today. Certain makes will be preferred. When these are available, the others become extremely hard to sell. Are you rendering your customers any service by stocking makes which are *not* their *first* preference? Or are you really playing fair to

yourself to stock brands which will require difficult selling and price cuts to move?

The selection of the particular brands on which to concentrate becomes the difficult question. Up till now, radio merchandising has lacked the stabilizing force of national advertising. This situation, too, will change this fall. Dealers no longer will be called upon to bear the entire selling burden. Great national magazines and powerful newspapers will carry the story of worthy radio products into the homes of America long before the contemplated sale. This fall and winter, purchasers will be actually created, and prompted on their choice by the powerful advertising which will segregate in their minds the wheat from the chaff.

By all means, therefore, find out the exact advertising policy of every concern whose products you consider seriously. Nation-wide advertising, giving the impression of nation-wide sale, in itself cannot help create a feeling of confidence. The head set manufacturer, for whom the investigation cited was made, has laid out a policy calling for a great advertising campaign, fully adequate to create a consumer demand for *his* entire production. Of course, experience has already proven that his product and his price satisfy the purchaser, and he is taking no chances whatever, in widening his market. A few—still only a few—of the other phone makers are acting similarly. Naturally enough, these far-sighted concerns are in nearly every case those whose products have already proven their worth in actual use, and who now enjoy an enviable reputation among the radio "hams."

Any dealer can easily find out just who these particular concerns are. Then, by concentrating exclusively on those few brands, you will not find yourself loaded up with unknown (to the great consuming public) hard-to-sell makes. It is far better to offer a customer a brand of apparatus with which he is familiar, and in which he has confidence, and which he accepts without question, than to waste ten or twenty minutes of time explaining, arguing, and as-

(Continued on page 57)

Concerning "Canned Music Now Broadcasted"

Don't Be Too Hasty in Condemning Broadcasting Station Programs Now in Evidence

By GEORGE H. FISCHER, JR.
Radio Dept., Pierce Electric Company, Tampa, Fla.

Merchandizing of radio apparatus like any other mechanical or electrical device requires demonstrations. We could hardly expect to sell an electric washing machine or a vacuum cleaner without first demonstrating, nor a phonograph without playing a record or two.

An electrical appliance business could not be successfully operated where no current was available nor a phonograph sold where records could not be procured. What then is the likelihood of selling radio sets where nothing can be heard during the day? All the sales cannot be made at night when atmospheric conditions are favorable.

In the territory where broadcasting stations are found in great numbers the "canned music" may have little appeal but in the territories at a distance beyond the daylight range of the big stations it is almost a necessity.

Our dealers had been obliged to try to sell a radio set without being able to give the prospective "fan" any idea of what radio was like other than to let him listen to an occasional ship out in the gulf or the ever-present "static." Realizing this, we installed a small broadcasting station, now WHAW, for the purpose of aiding these dealers. Of course, phonograph music was used. The thing took well and we established a schedule, playing from 12 to 1 p.m. and 4 to 5 p.m. This permitted demonstrations at times when the business people were on the street, at lunch hour and after office hours in the evening.

To our surprise we received many requests from radio "fans" for evening programs which we now give from 8 to 10 p.m. on Mondays and Saturdays. Our modulation is good, about 80 per cent. and our program, made up entirely of phonograph records. "Listening in" on some of the "live programs" of some broadcasting stations the writer has heard attempts of amateur entertainers which would have failed to get by at the local picture house. Aside from the value of the broadcasting of "canned music" to the radio retailer the phonograph concert can be made an enter-

taining one for most any type of listener.

Too many stations have persisted in filling the air with "jazz" and nothing else. Following is a sample program of ours made up of phonograph records:

Bed time stories: Cinderella and Little Red Riding Hood, Porter.

Overture: Rifle Regiment, Marine Band.

Tenor Solo: O-sole-mio, Caruso.

Piano solo: Prelude F, Rachmaninoff.

Popular number: The Sheik, Club Royal Orchestra.

Violin solo: Souvenir, Kreisler.

Quartette: My Mammy, Peerless Quartette.

Soprano solo: Barbieri, Galli-Curci.

Orchestral: Walküre, Philadelphia Orchestra.

This much gives a good idea of what a variety can be obtained and the class of entertainment furnished. On the other hand we have listened to "live" programs on which appeared choruses from a Sunday school and amateur "pick-up" jazz band and lectures by long-winded orators with no time limit and uninteresting subjects.

Some day, in the near future, we hope, the broadcasting stations will be served through an entertainment circuit similar to our vaudeville or Chautauquas and that the material shot into the air will be acceptable to all.

Meanwhile, let us not be too hasty in "Canning the Canned Music" for in many cases it is well worth listening to.

The Radio Dealer The Most Important Factor

By H. G. CISIN

Author of the Radio Telephone Handbook

The radio dealer should realize that he is the final and perhaps the most important link in the manufacturers' chain of distribution. He is the one who comes into actual contact with the radio-buying public, and he is the first to feel the effects of changes in the radio situation.

In order to protect himself and to insure success, there are certain things which the radio dealer has the right to expect and even demand from the manufacturer whose goods he handles. High-grade equipment is one of the most important of these. As one who is in the radio business to stay, the dealer should make it an inflexible rule to handle nothing but quality apparatus and should absolutely refuse to deal with manufacturers of cheap, shoddy material. The dealer should get a fair margin of profit and in addition he should have the unqualified support of the manufacturer. That is to say, the radio

dealer has the right to expect the manufacturer to advertise widely and in such a way that the dealer will directly benefit. Rapid turnover of stock means prosperity for both manufacturer and dealer. The radio dealer has already recognized the fact that he is merchandising a specialty and not a necessity, and he should confine his purchases of radio equipment to manufacturers who also recognize this and act accordingly.

The manufacturer should back up his dealers, not only by widespread national advertising but also by local advertising. The dealer should be just as much a part of the manufacturers' organization as the manufacturers' salesmen who come in contact only with jobbers. Up to the present time the radio manufacturers have been exerting their efforts in lining up their jobbers, and the dealers have been left to shift for themselves. This

(Continued on page 102)

Many Important Details in Manufacturing Phones

Valuable Pointers on Head Sets That Will Aid Manufacturers and Dealers in Their Buying

By CHAS. H. LEHMAN

President, Dictograph Products Corporation

It is a recognized fact that the telephone head set is a vital element in every radio receiving set and this holds true regardless of whether a crystal set or a vacuum tube set is involved. In the case of a vacuum tube receiving set, it is essential that the telephone head set should compare in sensitiveness with the remainder of the apparatus. With the crystal receiving set the substitution of sensitive telephone receivers for poorly constructed ones will practically double the efficiency of the set.

In view of the extreme importance of the head set in radio work, it is rather surprising to find that the average user does not understand the basic principles involved in the choice of a telephone receiver for radio work. There are still a number of radio fans and also radio dealers who judge a head set solely on the basis of its resistance. Without a correct comprehension of other elements involved, such a basis is sure to prove extremely misleading. The reason for this will be explained later. Since the telephone head set used in connection with radio receiving must respond to very minute currents, its most important requirement is that of high sensitivity. It must also be designed to give loud responses without rattling or distortion. The materials used must be such that the receiver will retain most of its magnetism indefinitely. Beginners often bring up the question as to why good telephone receivers cost more than the poor ones although the latter apparently look the same and are claimed by their makers to be suitable for all radio purposes. It would be just as logical to compare an Elgin or a Waltham watch with the ordinary dollar variety. It is true that both are watches and both perform the function of telling time but the high-grade watch is an accurate, dependable instrument which will stand the test of time. In many ways the high-grade telephone receiver is comparable to the quality watch. Like the watch, it is a sensitive, finely constructed precision instrument made to give service for years. However, it differs from the good watch essentially in its ruggedness and ability to stand abuse. While the analogy between telephone head sets and watches is very apt, it should be noted that the

difference in price between a high-grade telephone head set and a poorly constructed one is not nearly as great as the difference in price between the good and the poor watch.

The telephone receivers used for radio receiving sets operate on the same principle as ordinary telephone receivers. The incoming currents pass through electromagnets, thus affecting the strength of the magnetic field and in this way causing the soft iron diaphragm to vibrate and emit sounds of practically the same nature as those entering the distant transmitter. As in the case of any other electromagnetic circuit the magnetic force is directly governed by the current strength and by the number of turns. Our technical friends would state that the magneto-motive force is equal to the product of the amperes flowing times the number of turns. Since the current flowing in radio receiving circuits is necessarily small, it is therefore essential to have as many turns as possible in order to build up the ampere-turns, and hence the magnetic force. In order to get a large number of turns into the small space available it is necessary to use very fine wire. The use of this wire results in a high-resistance telephone receiver and this is what originally gave rise to the resistance method of judging telephone receivers referred to above. Because of the difficulties involved in winding very fine wire, certain unscrupulous manufacturers substituted thicker German silver wire having high resistance in the place of the fine copper wire. In this way they obtained a high-resistance receiver, but one lacking in sensitiveness because of the vastly decreased number of turns. From this it is obvious that in order for a resistance rating to mean anything in connection with a telephone head set, it should be accompanied by a statement of the size and material of the wire used in winding the receiver as well as the number of turns.

When the fact is taken into consideration that No. 40 B. & S. gage wire takes up more than twice as much room as No. 44 wire, the advantage of using the finer diameter No. 44 wire becomes apparent at once. More than double the number of turns can be put in the same space and thus a very sensitive telephone receiver can be ob-

tained. However, trouble comes as soon as the inexperienced manufacturer attempts to wind his magnets with No. 44 wire. In order to get quantity production the magnets must be wound rapidly. Anyone who has had experience with No. 44 wire knows what is likely to happen to the novice who tries to handle and wind it commercially. His machines cannot wind such fine wire rapidly without breaking the wire time and again. As a result, the inexperienced manufacturer compromises by using No. 40 wire. Even if he makes a much larger, heavier and bulkier receiver he finds it impossible to get the same number of turns as in the case where No. 44 wire is used and hence at the very start he is unable to make the most sensitive possible telephone receiver. Of course, size of wire is only one of the factors entering into the construction of a quality head set. Accurate construction is very important in order to insure a minimum air gap and one which will be absolutely the same in every telephone receiver turned out. The soft iron diaphragms must be of uniform thickness throughout and each diaphragm must be tested to respond to the same frequencies. The magnetic circuit must be properly designed to insure a strong magnetic field and permanency of magnetization. In this connection it should be stated that the materials used for constructing the permanent magnets must be specially selected. If the steel used for the permanent magnets is not properly selected and heat treated it will be found that these magnets will be anything but "permanent."

High-grade telephone head sets receive a number of factory tests before they finally receive the foreman's stamp of approval. The raw materials are carefully inspected and if not up to the requisite standard are rejected. Each piece, as it comes from the machine, is subject to inspection and test and the slightest flaw is sufficient to cause its rejection. Each magnet spool is tested to determine its resistance and when the receiver is assembled the total resistance is again measured. The receivers are next tested for grounds and if all tests are satisfactorily passed they are finally

(Continued on page 59)

Editorial

Industry Bound to Grow Day by Day

"How big is the radio business going to be?"

That's the question often heard in the radio trade and is often not answered because the recognized "leaders" in the industry do not care to hazard a guess.

Judging from the broadcasting activities the interest likely to be developed is very large, for there are now just about 500 licensed broadcasting stations.

Stop and consider the fact that broadcasting stations cost at least \$5,000 and sometimes as much as \$25,000 to instal. Taking the smallest figure it means that \$2,500,000 has been invested in broadcasting stations.

The operation of these stations is another expense, running from \$1,000 upward the month.

No one knows how much money is already invested in factories producing radio apparatus. Most of us are aware of the fact that there are almost one million receiving sets in use in the United States.

Some of us know that there are more than 20,000,000 homes in the United States and almost every one of these homes can be reached by the present broadcasting stations.

Over three thousand manufacturers are reported by one agency—Estimates as to the people employed in these factories place the radio industry well among leading businesses of today.

There is no "stop" to radio. It must go on to the point where almost every home will not be considered complete without a radio receiving set.

With proper care every home can have a set and then the radio business will have surpassed the phonograph and motion picture business, in importance.

Epidemic of Expositions Due This Fall and Winter Season

Not enough warning has been made, it develops from talks with the trade's leaders, about the expected Fall epidemic of expositions.

Radio came along with a great big bang and promoters of all sorts jumped on the band wagon and proclaimed themselves managers of "radio expositions" and conventions.

Some of the schemers put over their pet money-making schemes and more will surely make similar attempts this coming Fall and Winter season.

Writing about radio exhibitions in the *Q. S. T.*, Kenneth B. Warner, editor of that excellent periodical, declares the great interest manifested by the public in radio made it possible for promotions of expositions.

Here's the way Editor Warner tells the story:

"The stage was all set for showmen, exposition promoters, manufacturers, jobbers, dealers' associations and what not to jump in and introduce the curious public to a mystifying, stupendous, alluring, educating, magnificent, inspiring conglomeration of radio shows, exhibitions, expositions and conventions, such as the country has never seen before.

"Some of these have been successes and have given as well as taken, but how many have been nothing more than schemes for making money quickly with the least possible outlay at the expense of the novice and general public?

"Or of advertising apparatus of inferior production * * * or of promoting stock-selling companies.

"In each morning's mail we get a notice of radio exposition in some out-of-the-way place, where we will be given the privilege of renting a booth absolutely free for \$100. An opportunity we cannot afford to overlook!

"How long will the public fall for this stuff; how long will it enjoy looking at a cheap crystal apparatus with a 1,000-mile receiving record or listen to loud, but not clear speakers, blaring forth some drunken refrain, or examining with interest a booth completely equipped with a table and porch furniture.

"Just about one season more and then we'll settle back to a couple of big classics each year like the automobile and electric shows."

The *Q. S. T.* secretary says the promoters are trying, very, very hard to enlist the support of the American Radio Relay League—but the association is not for sale.

Like *Q. S. T.*, THE RADIO DEALER is disgusted with the antics of some of our get-it-quick folks in the radio industry, who are always aiming to be on the receiving end. They know nothing of service and do not care what opinion is expressed anent their activities. Some of these get-it-quick fellows are in the "show business," while others are sitting in the high places in the radio industry.

But their reign is short and will be made decidedly briefer by the honest opposition of papers like *Q. S. T.*, and THE RADIO DEALER congratulates the *Q. S. T.* folks on their stand, endorsing every word of their August editorial.

THE RADIO DEALER is not opposed to radio expositions, but we do not believe that the trade's best interests are to be served by a great number of shows. There are too many announced now for the Fall and Winter season.

The real exposition should be supported and THE RADIO DEALER will give publicity to show promoters who deserve the trade's support. THE RADIO DEALER declines to support the fly-by-nights, just like *Q. S. T.*

Curbing the Fake Stock Promoters

Many daily newspapers and magazines are now giving a great deal of publicity to activities of the fake radio stock promoters, and the timely warning being given will be of great benefit.

For one thing it will save a lot of people considerable money and, secondly, will have the tendency to destroy the ambitions of promoters whose only desire is to fleece the public.

THE RADIO DEALER urges every legitimate business man in the radio industry to make a personal issue of every fake stock promotion that becomes public.

Investigate every "offer" you hear about and if it is not legitimate pass on the word to the Post Office Department for investigation, or report to the nearest district attorney for attention.

If you read a radio stock advertisement in a newspaper, write a letter to the publisher of the newspaper, asking whether he will guarantee the radio stock advertised.

In the interests of the radio industry every retailer is justified in displaying a sign, reading: "Don't buy radio stocks without consulting your banker."

THE RADIO DEALER has within the past few weeks, declined to carry advertisements offered by certain concerns claiming to be "radio manufacturers" because our investigations have disclosed the fact that these "manufacturers" are operating "factories" as mere "blinds" for stock selling purposes.

Some of these concerns have high-sounding names, and apparently are making a big drive for their business. They are interested in showing "suckers" a lot of unfilled orders—that being their excuse for seeking capital.

One concern, capitalized at \$1,000,000—operating from New York City—has had four different offices in the past six months—due to poor business, at stock selling and worse business in their factory.

Another concern—capitalized at \$100,000—cannot pay bills for electros and while it advertises its big factory, in reality, hasn't made one single piece of radio apparatus in its plant.

The "daily takings" for stocks sold, apparently, are going to the promoters.

One other concern claiming to operate wholesale "branches" in many cities isn't meeting its bills for radio parts purchased. Their daily receipts

for stock goes to pay office and "factory" rentals and to salesmen.

Pass on the word, brethren—let's scotch the fakirs now. This is the time. When the fall business rush comes along, it may be too late for the fake stock promoters are certain to take advantage of the increased activities in the radio industry.

Trade Associations

When the RADIO DEALER, in its first issue, urged the organization of a trade association, there was no organization in the field covering the dealer or manufacturer.

Since that date several attempts at organization of associations of one kind or another have been made. Of some of these organizations the less said the better, while some others have striven with high aims and attained little success because of the narrowness of the promoters.

Out of the mass of organizations that have been promoted a few have managed to survive, standing head and shoulders over the rest. Of these few, even, all may not survive, but out of the mass of confusion and duplication of aims will eventually spring strong trade organizations that will truly represent this great industry.

After the meeting at Washington last month the National Radio Chamber of Commerce elected new officers and outlined a series of plans that, if followed, will identify this exclusively manufacturers organization as one of the leaders in the field. While no final official report of the work they plan has been issued, reports from the officers point to a long period of usefulness for this organization.

With its membership restricted to manufacturers this organization has a great work cut out for it—a work that should benefit the industry at large in no small measure.

The RADIO DEALER wishes to go on record at this time as being opposed to its designation as the "official organ" of any trade organization. Trade organizations and publications have many things in common, but no organization can afford to tie itself to the policies of any publisher, nor can any publisher afford to tie himself to the policies of any trade association.

There are other worthy organizations in the field. Local associations in several states, the Pacific Coast Association, and last, but not least, The Radio Trade Association.

The RADIO DEALER wishes to go on record now as having no private axe to grind in the organization of the

Radio Trade Association. This body is absolutely separate and distinct from this publication. The RADIO DEALER is doing nothing more than what is conceived as its duty to the trade in pushing this organization. As soon as the organization is strong enough to walk alone the editors of this publication will urge that offices be rented in another building where the connection between the paper and the association will be completely severed.

The Radio Trade Association is FOR the radio trade. Nominations for officers are now coming in. Full details will be sent to members in a few days after publication of this issue. As soon as the final nominations are in the entire membership will have an opportunity to vote on the officers for the preliminary months before the first meeting.

No member of the RADIO DEALER organization will vote in any of the contests, nor will any member of this organization accept any office in the association after the annual meeting.

Properly managed the Radio Trade Association can be a great power in this industry. The RADIO DEALER has no other desire than to see this association properly started. Once working full blast our connection should be no more than that of *Radio News* or any other publication in this field.

Business Improving

Conditions in the radio trade, as shown by the RADIO DEALER trade research now being conducted, point to better business for the trade.

Cooler weather is bringing residents back home and the forecast of long winter nights has brought many people to thinking about their radio sets, and ways that they can be improved.

The willingness of retailers to sell on terms, similar to methods used in the music and phonograph trade is also having a beneficial effect on trade.

Broadcasting stations that have been suspended for the heated term are resuming and broadcasting programs are being improved.

Unless all signs fail business is already better than for some weeks, and will continue to improve.

Service

It is with pleasure that THE RADIO DEALER reports numerous letters expressing satisfactory returns obtained through our Service Bureau. Each mail brings many inquiries as to where needed parts may be obtained. If you need anything "Ask Our Service Bureau."

No Need to Worry Over Foreign Goods

Some of our American business men are worried at the possibility of large imports of German-made radio apparatus. This is an idle fear. There is no danger to the radio industry from this source.

It is said Germany is "going ahead" manufacturing complete sets that retail at five dollars, but these German-made crystal sets can hardly be sold in the United States—for we have sets at such prices, and our sets are the better made.

Patents (basic and otherwise) now held, or claimed by American radio manufacturers will prevent the importation of parts from Germany.

America has gone so far ahead in radio development that it will hardly be possible for Germany ever to "catch" us.

The Future of Radio

Some of the "weak-kneed folks" in the radio industry—and such are in evidence—should bear in mind the fact that there is a vast interest today in commercial radio; that right now the wireless is used for telegraphy and has now been perfected for telephony.

What will the next few years bring forward? Who can tell?

The best electrical engineers in the country are studying radio and may reach scientific heights undreamed of by the present developers of radio.

This does *not* mean that the present apparatus—tube sets and everything will become "junk." Don't get that impression.

New things are being developed rapidly, of course, but these new things are to be used upon present "sets" and as adjuncts to current radio equipment.

The future of radio is unknown—except that it will always remain as a business for thousands of retailers, jobbers and manufacturers.

Broadcasting Censorship

Federal officials in the Custom Service, which branch has supervision over radio activities, it is said, favor strict censorship of broadcasting, with power to eliminate inferior or objectionable material.

It is believed that this censorship will be of great value to the entire industry and will make for more pleasant ether entertainment.

"Experts" would check up, it is said, on the various features offered on the programmes, thereby eliminating all sorts of duplication of entertainment.

It is obvious, in the Metropolitan section, for illustration, that if several broadcasting stations desire to broadcast the results of baseball games or Wall Street prices the public will receive the same news at various times. This makes for unfavorable opinion and one of the things most essential for radio today is the acquirement of the good opinion of radio apparatus owners.

As the radio buyers are pleased so are they increased, for they do advertise and the best publicity that can be had is via the radio public.

This valuable public approval can be had only in one way and that is through the offering of real entertainment.

Some of the licensed broadcasting stations are not now employing their license and it might be interesting to learn why they are not broadcasting.

Are they awaiting the time when they can sell air advertising?

It is interesting to note that the Westinghouse folks at Pittsburgh are on record as being opposed to the use of the air for advertising. They "tried it out" and found that the public did not approve and of course, immediately, changed their programmes.

It seems plausible to assume some sort of censorship shall be developed—not because the air will be befouled with indecencies, but because the radio industry will best benefit from such censorship.

Why cannot the several broadcasting stations agree among themselves on programmes, rather than place themselves under governmental dictation?

To permit the Government to dictate broadcasting programmes seems a far-fetched idea. It will not help the industry, because governmental activities are often bureaucratic.

Broadcasting folks are, in the main, interested in the development of the industry. This is fairly so. Why shouldn't they encourage air entertainment? Newspapers and department stores benefit from the advertising developed by their activities. There can be no complaint about this.

But to get back to censorship, it should not be developed to burden the industry; there should be no handicaps to broadcasting; there should be no restrictions to the point where one concern is favored over another. Governmental supervision may make for unnecessary censorship of activities rather than good programmes.

At this time the best interests of everyone can be conserved by a mutual understanding between broadcasting stations and an honest effort to please the public. Competition will make for real programmes.

In this connection it might be pointed out that the broadcasting efforts of the Metropolitan stations are commendable. Their programmes have been delightful, they have been diversified and intelligent, and they have been pleasantly received.

Censorship, after a fashion, is necessary, but the RADIO DEALER believes that the censorship should be controlled by the folks in the trade rather than by the Government.

Radio Retailing Property of Radio Retailers

The time is ripe "for so-called national radio concerns to advertise to the point where radio dealers can proudly point out to their customers that their line is properly a "standard, advertised line."

Some of the large concerns are preparing Fall campaigns, it is said, to promote a demand on the part of the public for their brands and some have already commenced their appeal to the consumer.

THE RADIO DEALER believes that its reading clientele—the present radio retailers and jobbers—will heartily support any and every movement that will tend to bring standard equipment before the public.

The retailers of radio are today, in great numbers, exclusively handling radio. Only a percentage of electrical stores do carry radio apparatus and too many do so in a desultory manner.

Too many electrical retailers believe they have "a divine right" to the radio industry.

Who had "a divine right" to the automobile business? The makers of wagons and carriages! Where are they today?

Who had "a divine right" to the selling of phonographs? The piano stores. We know better today?

Who had "a divine right" to the movie industry? The folks in the theatrical business. Not so, for the big men in the movies were not theatrical people in other days.

Radio is not an adjunct to any business. Radio apparatus can be sold by hardware dealers, drug stores, department stores and electrical stores.

But, the major part of the business will be done by radio dealers and as the makers of radio apparatus are, in the main, newcomers to industry it becomes them to "hew to the line" and to advance in proper fashion.

They know that the new retailers, the radio retailers, must be "educated" and advertising for the public approval will make for stabilization and assured success.

Broadcasting Stations Should Know Government Owns the Air

The question of air ownership in the United States, it is said, has never been properly decided in courts, but several cities and some states now legislate against certain aeroplane activities, and their edicts have been upheld by the courts.

The sovereignty of the Federal Government seems unquestioned, however, when attention is directed to the fact that the United States attended the convention for the regulation of air navigation, and agreed, under "General Principles," to the following:

"The high contracting powers recognize that every power has complete and exclusive sovereignty over the air space above its territory."

This is the international rule, yes—but it makes it obvious that the Federal Government believes itself properly within its rights in taking command and issuing dicta on radio and aeroplane air usage.

At this time the five hundred licensed broadcasting stations are in accord anent their activities—due to a "gentlemen's agreement"—and if they can maintain that attitude the radio industry will profit properly.

If the "broadcasters" start warring the entire trade must suffer, and it behooves the so-called "big fellows" not to assume that they, alone, can properly produce pleasing programmes, or that they, by "divine right" of some sort, are to be favored when broadcasting schedules are made out.

Broadcasting activities should be carried on by the trade—of course, but if department stores and newspapers are anxious to extend service, it's quite all right.

Some of our so-called "big folks" in the radio industry are maintaining "a divine right" attitude. This is unfair to themselves, to the public, and to their competitors.

Naturally some of the older business organizations in the radio field resent the advent of many newcomers. Some of the "big fellows" seem to think the new folks are of one mind; that they are mere money-grubbers—in the main "fly-by-night" concerns which are in the radio industry only for the profitable moment.

It is true some of the newcomers in the radio industry have not helped along the industry in any manner. It is true some of the "pioneers" have done much to make the radio industry what it is today.

There is no sure rule anent these matters. No one knows just who among us is legally or morally authorized to cast the first stone.

To get back to radio broadcasting, the broadcasting stations should agree among themselves, and if the gentlemen cannot foresee what is likely to happen if they commence an "air war," then they're indeed stupid.

THE RADIO DEALER doesn't believe any of "the divine right" radio folks will dare violate any gentlemen's agreement, because the moment they do the Federal Government will step in. Do the "big fellows" want that?

Some of us believe they do, because the "big fellows" in industries other than radio appear to have the Federal ear, as against the people.

But radio is different. If the "big fellows" will not "play square," the American public can resent such mischievousness properly, and it is generally believed the "fans" can properly interfere with broadcasting if it is, in any manner, made a monopoly.

Broadcasters, gentlemen—let's agree to agree.

A Valuable Form of Advertising

A Few Practical Hints that May Be Applied with Profit; The Advantage of the Sign at the Store Entrance

By ANDERSON DWIGHT

Advertising in one of its various forms is recognized by alert manufacturers, jobbers and retailers in every field as a necessity in present-day trading. Of course, there is a wide difference in opinion as to what constitutes sane and profitable advertising. To be odd and freakish is accepted by some merchants as good advertising because of its intrinsic powers to attract attention. Aside from the point of luring the eye there is a more important duty which a business man owes to himself and those about him, and that is: To help in building up a thriving trade.

It is a general tendency, not to say a weakness, for a business man, responsible for the growth of an enterprise, to wander into a far-off and unknown channel and there experiment and receive his first lesson in advertising. This is especially so in the case of new men in the radio and electrical field. Students who graduate from that school of hard knocks—experience—pay dearly for their lessons. The time and trouble invested, in many instances, could have been saved if the person to whom is assigned the duty of guiding the destiny was not of the sort to give way to sky-rocketing ideals.

Advertising is a matter which must be decided upon after one thoughtfully considers the merit and nature of a proposed medium. It is not a question whether or not a merchant should aim for an exacting clientele, but it concerns him as regards advertising to associate himself with the better class of advertisers. It is easy enough to become popular, but popularity often consists of persons saying things that they assume to be so. Advertising leads the reading public to think. What they think of the article or articles advertised and the advertiser depends upon the medium adopted by the merchant to some extent.

An advertisement in a publication that is of a class nature is assuredly better than a similar expenditure in a publication of a general circulation which is read by men, women, grandmothers and grandpas. More than once manufacturers and retailers have decried the value of advertising, and

that because they were not successful in disposing of sufficient quantities of the articles they advertised. What is said in an advertisement, too, figures prominently in what may be expected in return for the outlay. A large space may be used for "advertising" in good sized type an article of true merit, and to this may be coupled glittering generalities as to the wonderful qualities of the article set forth. But flowery speech has seldom been known to satisfy the seeker of quality. At any rate if he is located in a distant place and pins his faith to the honesty of the advertiser he will naturally select the advertiser who describes his merchandise in a clear and concise manner. The public seeks the truth in most things and what is most pleasing to the ear is an expression of honesty. The giving of real value for money has been repeated so successfully in advertising that it is needless to enter into detail on this summary.

Just above the door-spot of every wholesale house or retail store may be found a space which may be adapted at little cost and much to the profit of the parties concerned. Many business merchants are awake to the fact that a handsomely-lettered, neatly-designed sign in front of the business place is an advertisement of great attracting power. This is at present being overlooked by the busy radio merchants whose eyes are fixed on the distant horizon. In the far-off lies his future, it would seem, and to that distant zone he will give his attention as a poet would dream.

It is not well to say that a manufacturer or retailer is not successful because he estimates his time as of greater value if directed along the lines of a hobby. Business is a thing which can be developed in numerous ways and if a merchant succeeds in keeping his creditors from the door legitimately and with profit to himself he deserves the respect of his colleagues.

The business place or store is the foundation upon which is built a monument of brains and energy. What is done in this structure is known to the public through the medium of advertising. In a new business enterprise the sign on the door is the first

intimation an outsider has that such-and-such a business is conducted there.

If the sign is small and represents cheapness, a like impression of the business itself is conveyed to the mind of the beholder. If the sign is neatly planned and prepared the importance of the firm or person is greatly enhanced in the estimation of the person or persons who gaze upon it each day. But it should not be so gaudy or over-elaborate as to excite the suspicion that the exterior decorations are the only asset an establishment has, or that an attempt is being made to attract people on the strength of them alone.

There are signs and signs—some of which carry a meaning and others which leave the passersby to guess for themselves. A shingle on the house front may read: "John Smith, Electrical Store," but this does little in the way of influencing the person who viewed the sign. Electrical stores are quite numerous and electrical things can be purchased in so many places that the product of John Smith must take its place among the thousands of things electrical made by many factories and "advertised" by sign space in a similar way by merely saying that they sell electrical things. It never occurs to them, perhaps, that the word "quality," before "Electrical Store" would prove a valuable addition and seem to distinguish the Smith product from that of other manufacturers. Or even the word "modern" would mean something.

Advertising space in front of the place of business does not involve an expense. The only real cost necessary to reap the advantages of this advertising is a little thoughtful consideration of the best way to impress on the public the merit of the goods and the importance of purchasing them. Paint is cheap compared with other outlays which bring little or no return, and an investment in a good-sized sign expressing a strong point in favor of the merchandise sold is a form of advertising that pays big dividends. A big sign is synonymous to a big front and the merchant big enough to exploit his

(Continued on page 62)



G R L Products

Every business has back of it an ideal—the principle on which it is founded. The General Radio Laboratories have endeavored to pick out from amongst the many varied, and often not too reliable radio equipment, items which after thorough laboratory and practical test it feels it can offer to jobbers, dealers, and manufacturers with every assurance that the item is all that its manufacturers claim it to be.

We offer for immediate shipment the following reliable and practical equipment, at attractive discounts. Write for catalog.

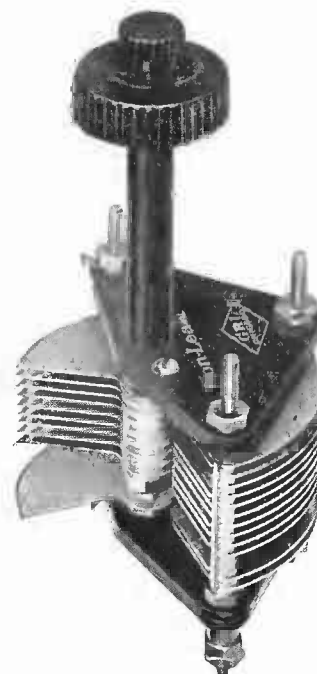

Red Star
Head Sets
2000—2400
—3200 Ohms

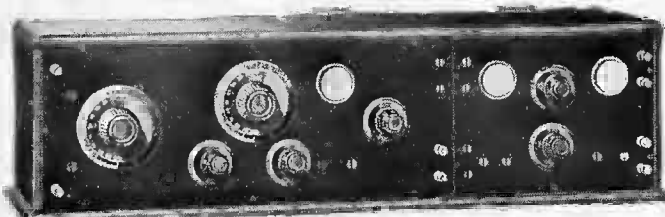

Series B2

- Red Star Radio Telephone Receivers
- Non-Leak Variable Air Condensers
- Uradiola Receiving Sets
- Uradiogrand Receiving Sets
- Variable Condensers "S" Type
- Radio Plugs and Jacks
- Amplitone Wire
- French (Ray-o-Vac) "B" Batteries
- GRL V. T. Sockets

- GRL Variometers — Variocouplers and Potentiometers
- Dials and Knobs
- Binding Posts
- Magnet Wire

7 S. Dearborn
Street

General Radio Laboratories

Chicago,
Illinois

INCORPORATED

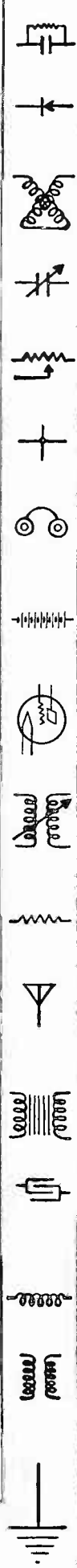
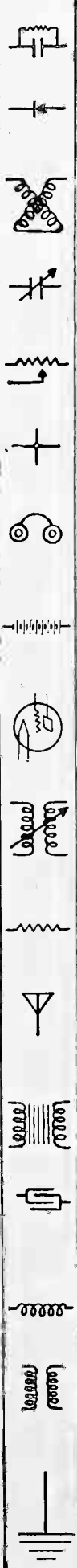

Territorial Limitations of Trade-Mark Rights

Use of Trade-Mark Must Be National to Ensure National Protection

By CHAUNCEY P. CARTER

It not infrequently happens that the use of a given trade-mark is for many years restricted to a limited territory, sometimes its use does not extend outside of the State in which the proprietor has his place of business. It also not infrequently happens that the same or a closely similar mark is being used by another firm on the same or similar goods but in another restricted locality. Each user is unaware of the other's use until expansion of business by one or both brings the conflicting marks into the same territory. Then the fireworks start.

If the courts had only to consider the interests of the two trade-mark owners their task would be a simple one, as award might properly be made in every case to the one who first adopted and made use of the mark anywhere or at least anywhere in the United States. The interest of the consumer and middleman must be considered, however, and it is this interest that has led to the so-called doctrine of territorial limitation of trade-mark rights in this territory, a doctrine that has within the last few years become firmly established under sweeping decisions of our highest court.

As far back as 1909 a Federal court held that where one firm had sold rye whiskey under the name "Baltimore Club" in Baltimore and vicinity for over thirty years, and another firm had also used this name for whiskey in New York City and vicinity for over thirty years, even though the Baltimore firm were the earlier user, it would not be proper for it to invade the territory of the New York firm since whatever reputation or value attached to the name in New York and vicinity arose from the efforts of the New York firm and the quality of its whiskey, and to permit other whiskey to be offered in that territory under the same name would simply act to deceive the public.

In 1913 another Federal court enjoined an Ohio company from using the name "Tea Rose" on flour sold in the States of Georgia, Florida, Alabama and Mississippi, where another firm had been using this name since 1893, although the Ohio company had been using the brand in question since 1872 in other territory. This decision was upheld by the Supreme Court in 1916.

The question came before the Supreme Court again in 1918 in the leading case of *United Drug Co. v. Theodore Rectanus Co.* The circumstances in this case were that a party in Massachusetts adopted the trade-mark "REX" for certain articles and registered it under the trade-mark law of Massachusetts and under the Federal trade-mark law of 1881. The use of the mark by this party was confined to the New England States during a long period of years. In the meantime a firm in Louisville, Ky., in good faith and without knowledge of the prior adoption and use, adopted and commenced to use the same mark on similar goods in Louisville and vicinity. The rights of the Massachusetts firm were eventually purchased by the United Drug Co., which soon pushed the use of the mark into

the territory of the Louisville firm, whence arose the lawsuit. Here again the Supreme Court disregarded the question of earlier use and upheld the right of the Louisville firm to continued and exclusive use of the mark in the territory in which it operated.

Trade-mark owners would do well to bear these decisions in mind, as the growing use of trade-marks and the failure of so many users to put their claims on record in the Patent Office is resulting in more and more duplication of trade-marks. When such duplication comes to light it is well to know that evidence of earlier use may not be sufficient to prevent continued exclusive use within a given territory by the late comer.

(Copyright, 1922, by Chauncey P. Carter, U. S. A. and Foreign Countries.)

The First Radio "Ad" Well Investigated

As a part of the regular Westinghouse broadcasted program, H. Gernsback, editor of *Science and Invention* and *Radio News*, and a radio pioneer, lectured from the Westinghouse sending station at Newark, N. J., on "The Radio of Twenty Years Ago." In the course of his talk he told how, when he first advertised a complete wireless telegraph set for ten dollars the New York Police Department investigated his plant upon the advice of the district attorney.

"I well remember the day," said Mr. Gernsback, while several thousand stations listened, "when the stalwart officer walked into my office 'looking for the fakir with a wireless telegraph.' Our set was operated by four dry cells and a one inch spark coil. In order to make it work at all we had to have a miniature antenna on the coil and a similar miniature one on the receiver, the latter composed of a coherer, decoherer and a dry cell. We demonstrated the outfit to our satisfaction but not to that of the policeman. He was not at all convinced, because, as he put it, 'If this is a wireless telegraph, why do you need all of these wires dangling and sticking out from it?' This may be thought of in the

light of a joke today, but in those dark days of radio it was anything but a joke and the police department came near branding wireless as a positive fraud. We finally convinced the officer by allowing him to walk around with the receiving outfit in his hands, while we tapped away at the other end of the room. Although he still growled about 'those wires' he finally departed more or less convinced."

Those were the wild and woolly days of wireless. It was then that the wireless experimenter was born. Now we have a new being, the radio amateur, who since 1904, when there were not one hundred stations in this country, has increased the working stations to several million.

In the beginning there were no laws affecting radio. Whoever owned the biggest spark coil and controlled the heaviest "juice" was czar and master of the situation. He simply drowned out everyone else and cared not a rap whether the other fellow put his message through or not. Not that it mattered very much, for the messages in those days were of the new and famous variety of "How do you get my spark?" and other similar existing news.

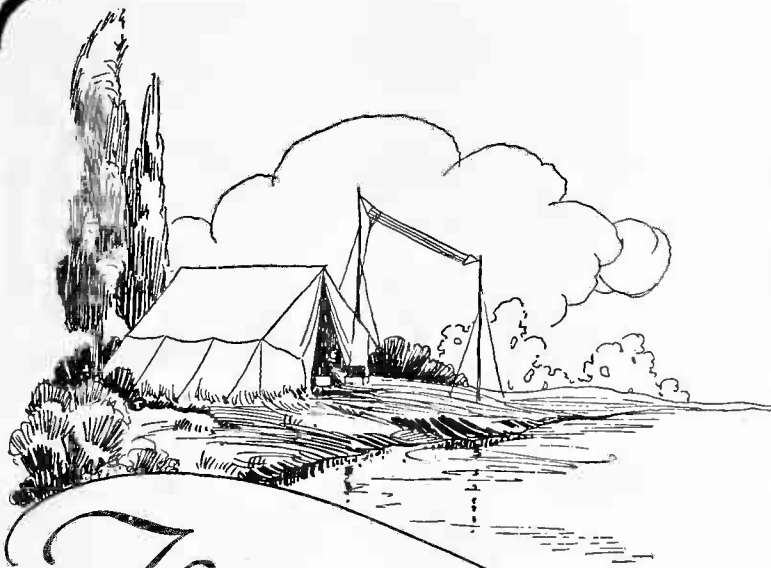

The ideal combination for VT control without the use of jacks or plugs.

We are the inventors and sole manufacturers of the famous Klosner Vernier Rheostat, Model 100, still being sold at retail price of \$1.50.

Dealers and jobbers send for proposition and discounts on the "Amplitrol" and the Klosner Rheostats. Ask for Booklet SN.

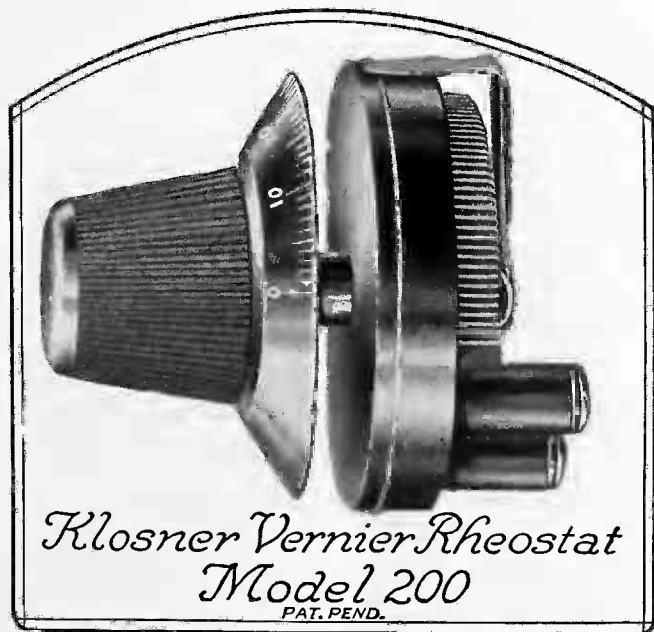

Klosner Vernier Rheostat Model 200
PAT. PEND.

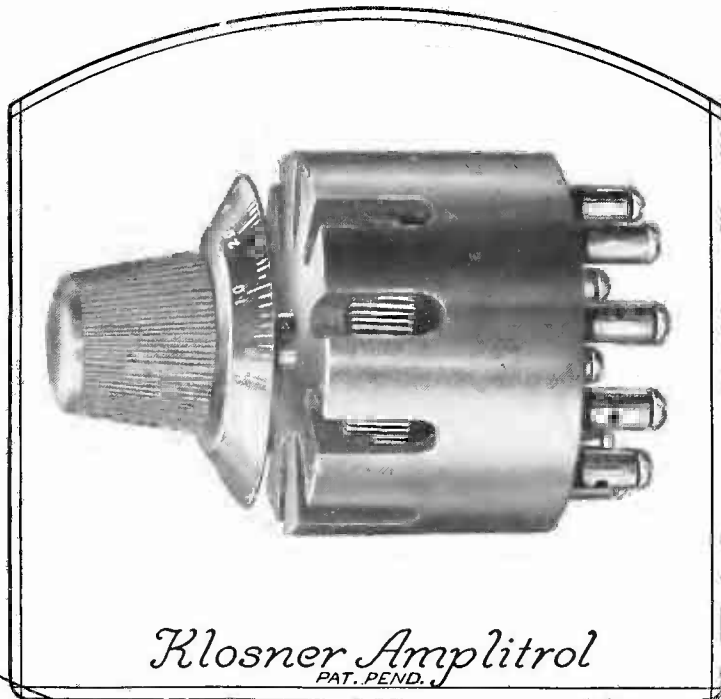

Klosner Amplitrol
PAT. PEND.

THE long looked for has at last arrived. The Klosner "Amplitrol" fills that long felt radio want—that of controlling the vacuum tube circuit without the use of jacks, plugs or any additional switches. A real radio necessity. Every amplifier tube deserves one. No more plugging in from one stage to the next. Simply attach phones or loud speaker to binding posts and turn on any stage at will.

The "Amplitrol" not only adjusts the filament to its maximum efficiency, but it automatically controls the plate circuit at the same time, thus eliminating an extra operation. Unlike an automatic filament control, the "Amplitrol" does not put a sudden strain on the filament. It provides a gradual current increase for the filament, thus prolonging its life.

Made of moulded condensite. Contacts of phosphor bronze. Exposed metal parts highly nickel plated. New style tapered knob, and dial correctly numbered in white lettering. List price \$4.00.

What the "Amplitrol" is to the amplifying tube, so the Klosner Rheostat is to the detector tube. The new improved Rheostat Model 200, embodies some vast changes and improvements. These are too numerous to list, but your inspection will immediately win your approval. The "Amplitrol" and the new improved Klosner Rheostat are the ideal combination for vacuum tubes. Klosner New Improved Rheostat Model 200. List price \$1.80.

The "Amplitrol" and the Rheostat do not employ the graphite-disc principle, but that of wire wound. This feature insures perfect contact at all times, making tuning 20 times quicker and louder and giving greater range.

Klosner Improved Apparatus Co.,
2024 Boston Road
New York City

Mica Diaphragms Minimize Phone Troubles

Most Excellent Results Obtained by the Use of Ruby Mica in the Construction of Radio Head Sets

By R. P. CLARKSON

General Manager, Radio Mica Products Co.
Chief Consulting Engineer, American Mica Works

In far off India, 300 to 400 feet below the surface coolies are working to make your radio set more perfect. There is no modern machinery there, but piece by piece these natives dig the rock from which we get the famous bell-tone India ruby mica for all our mica diaphragms for radio head sets. Not even blasting is used. A fire is built on the surface of the rock and as soon as it is heated, water is thrown on and the rock is cracked, then iron wedges are driven into the cracks breaking up the rock. These broken pieces and the waste are then passed from hand to hand along a line of coolies and women extending through narrow passages and up rude bamboo ladders until the surface is reached.

Very little of the mica rock that comes to the ground can be used for diaphragms. In some sections not more than a pound or two to the ton of rock can be trimmed into sheets and not more than twenty per cent of that can pass the tests given in laboratories for micaphone diaphragms. Much of the rest can be made into punchings of various kinds such as for magneto armatures. Some can be used for transmitter diaphragms in the ordinary house telephone. Much of it in small pieces is used for the best fixed condensers.

Mica must not be confused with isinglass. Mica is a mineral found in many parts of the world, the bulk of commercial mica coming from India, Africa, Canada and the United States. Isinglass, on the other hand, is a manufactured product of no value in radio. It is made from the air bladders of certain fish and is both soluble and combustible. Mica, although not very hard by scratch tests, is extremely durable, so durable in fact that when granite decomposes the mica particles still remain resistant long after the rest has decomposed. In elasticity, toughness, flexibility, transparency, high electrical strength, resistance to high heat and temperature changes, and resistance to weather, there is no substance known which approaches mica even closely enough to be known as a substitute.

Not all mica has these properties to an equal degree. There are micas and other micas. In general for diaphragm purposes there is little domestic mica of value. All first class clear ruby diaphragms must be of India mica although the South African green mica is splendid for this purpose but is objected to by many because of the darker color.

Many attempts have been made to devise something "just as good as mica" for diaphragm purposes in all kinds of sound producing machines but mica has always won out even though the cost is rather higher than what we would like it to be. The companies with which I am associated have made many hundreds of thousands of mica diaphragms for all kinds of purposes and they have gone out to nearly every important phonograph manufacturer, first in small lots and then in larger lots until today there is scarcely a well known phonograph but what uses mica diaphragms exclusively. The same change is now coming over the telephone field. The radio fan is responsible. For many years the entire effort has been devoted to getting volume—every beginner wants lots of volume. Today, however, the radio fan wants to hear what is going on. He wants clearness in speech, pure tone in music, sharp, clear signals. He wants static softened, all the metallic, tinny sounds eliminated.

The manufacture of phone mica diaphragms is in itself a considerable task. Stamping is impossible because the die or punch will ruffle up the layers of mica at the edge of the mica disc and spoil the resonant character of the diaphragm. Each piece must be carefully turned and this is hand work, very slow and laborious. A number of squares of the superfine ruby bell-tone mica are stacked together, interleaved with soft tissue paper to keep the mica from scratching and also to furnish a friction between the sheets. Mica is naturally highly polished when split and this polish is retained. The squares are clamped together and turned down to the size desired. Only a single cut

can be taken with any one tool without resharpening. A final finishing cut in oil is sometimes given to get a perfect edge and remove all dust and powder.

These turned discs ranging from four thousandths to twelve thousandths of an inch in thickness are then clamped in a drilling jig and by special means employing a peculiar type of drill, the center holes are drilled. The completed discs are then inspected and separated into grades. Number one diaphragms are as nearly perfect as possible for such delicate crystals to be. Number two diaphragms—second grade—are perfect except for possible stains, slight imperfections, air rings or bubbles. Number three or third grade have ruffled edges, imperfect machine work and possibly a tiny crack. They can be used only for experimental use while number two may be turned down and the imperfection removed. After once forming the diaphragm they cannot be split without spoiling them.

Of course, mica is not magnetic so a magnetic material must be added to the mica disc before the diaphragm is of any value commercially for head sets. This, too, is a delicate hand job. The little round armature that is added must be of a certain iron, a certain carefully determined weight and thickness, and of a proper diameter. It must be balanced at the center of the mica disc and still must be spaced from the mica just so far to give perfect results. Then the mica disc and the armature must be firmly fastened together so there can be no possibility of any loosening under the most severe loud speaker use and yet care must be taken not to crush the mica even the slightest amount or the tone is ruined. Inspection at this point is very severe and to avoid any poor diaphragms getting by, another inspection is made when the micaphones are marked with our trade mark. Two more inspections are made when wrapping the individual diaphragms in the tissue instruction sheet with the adjustable spacing rings so made as to permit

(Continued on page 60)

Station WBAY

American Tel. and Tel. Explains Air Advertising

The publicity department of the American Telegraph and Telephone Company recently sent out the following announcement:

"A musical program will be given between 11:00 A. M. and 12:00 N. and 4:30 P. M. and 5:30 P. M. weekdays over the new radio broadcasting station WBAY, which was recently erected on the Walker Street Building of the American Telephone and Telegraph Company. A program will also be given on Thursday evenings from 7:30 P. M. to midnight, to be announced later.

"Such a station, which is intended for commercial broadcasting, has been assigned, for the present, by the United States Department of Commerce, a wave length of 360 meters. This does not permit simultaneous operating with the other broadcasting stations operating on the same wave length in this area. As a consequence the available hours have been assigned to the different stations operating in the vicinity of New York by an agreement between the stations themselves and with the approval of the Department of Commerce. The above schedule of two hours in the daytime and four and one-half on Thursday evenings is the temporary schedule which has been assigned to WBAY.

A. W. Drake, General Commercial Manager, in charge of this station, says that there have been close to 100 applicants for the use of this station and he has taken steps to arrange with these applicants for the programs which they will provide.

"While radio advertising has not as yet been prohibited by laws or regulations, it is considered, in the public interest, that applicants for the use of this station should provide programs of general interest.

"Until the details of the scheduling of private programs can be arranged, WBAY will continue to furnish a miscellaneous musical selection."

RADIO A LA CARTE

Several hotels have recently installed receiving sets in their dining rooms and with the use of an amplifier and horn have given their guests music with their meals; but it remained for the Hotel Belleville, San Francisco, to substitute individual head sets for the horn so that each diner could listen in or not, as he saw fit.



No Wireless Receiving set is complete without

To show your customers the full use and enjoyment of a receiving set, demonstrate it equipped with the Magnavox Radio—the Reproducer Supreme.

The Magnavox Radio opens up your largest and most profitable radio market—by making it possible for the entire family to "listen in" at the same time.

Your profit margin is ample—your turnover on the sale of Magnavox Radio is rapid and sure. Carry it—understand it—demonstrate it—push it in your community.

Magnavox Radio consumer folders and other valuable "sales helps" link you up with the most interesting consumer advertising campaign in the entire industry.

The Magnavox Company

Oakland, California

N. Y. Office: 370 Seventh Avenue

MAGNAVOX

Radio

The Reproducer Supreme

Ideas for the Live-Wire Retailer

Courtesy and Sales

If Your Customers Think Well of You They Will Come Often

In the operation of a retail radio store great stress should be laid on courtesy. Its value as a business-getter cannot be overestimated, for in the practice of this quality the clerk wins the appreciation of those who come into the store, and the register each day will show the importance of this trait. The ways in which a clerk may reveal this all-important essential is the "thank you," which is lost in the soul of most retail store clerks. It costs nothing to be courteous, and the moral it teaches is obvious. Not long ago a customer forgot his umbrella in a retail store. He was a regular visitor at the store, and while he was not a liberal purchaser he was of the sort desirable.

The clerk remembered his name but vaguely as he had sent goods to the gentleman. He lost little time in getting hold of the telephone book and in a few minutes he was in communication with the party. He informed him that he had left his umbrella at the store. The customer called for the umbrella and while he offered to reward the clerk for the kindness shown, the offer was not accepted, so he placed an order with the clerk that made the receipts for that day soar far above that of any day for years.

The lesson of this is obvious, the clerk realized for the first time the great value of doing little things well, and today his store is one of the most thriving in his part of the city, and many persons go a long way to visit the establishment.

Window Dressing

A Practical Art to Which Radio Sets and Parts Are Well Suited

Window displays of a tasty sort are a real asset to any business. A skilled observer can detect enterprise, carefulness, judgment, good taste and discretion in window displays. If the displays are frequently changed the passerby is bound to notice it with approval.

Not only is it possible to make entire changes of window displays that will improve the entire appearance of the store from week to week, but it is also true that burlap in various

colorings is cheap, and by substituting a background of dark green and then changing to another color, the impression is given to an observer that an entirely new store has been started, and he will stop in one case out of three and look the place over with renewed interest.

Many a store has run down and become a white elephant because of the dirty and dusty appearance of the windows. People not only get a bad impression themselves but if the store is in any way prominent they pass the undesirable word along and the business capacity of the store is ruined. Even though the store be small, if it is situated in a little village or suburb, the whole community is passing judgment on it all the time, and if the opinions are of the approving kind the future of the store under discussion is almost assured from that fact alone.

In some radio stores the same identical window displays are adhered to for months. The dust quickly collects on the stock and the general appearance is decidedly bad. In fact some windows are more stock rooms than display stands.

A careful window dresser with an eye to the artistic will hit on various designs in placing the stock and various little incidentals may be brought into play to make a general effect that is most pleasing.

Retail Store Service

The Sensitiveness of Customers Not to Be Overlooked

The man who has made his way up the ladder from the bottom to the upper rung knows full well that it is not good policy to intrude upon the sensitiveness or reserve of a customer. Some men have their own individual peculiarities, while others appreciate a full share of "joshing."

It is for the man behind the counter to learn to quickly size up a customer. This is a long step toward the cultivation of the art of good salesmanship. Very often it happens that a customer wants quick service, and to hold them up at such a time with some sort of frivolous question or yarn would mean that that customer would go next time to the store where he is not so delayed or imposed upon.

Another customer may be found who likes to linger about and who would appreciate a little sprightly con-

versation. Should it happen that such is the case, it would be best for all concerned to let him lead and make known the topic he most desires to discuss. Nothing is more detestable to most persons than a salesman who evinces a desire to find out about the personal affairs of customers. The man who can recognize the different peculiarities of customers who come into his establishment each day has done much toward learning one of the real essentials in the art of salesmanship.

He could do no more than this toward holding his clientele and winning for his store new buyers each month. The man who forgets himself and who loses sight of the value of exercising the faculty will in time find out that he is ruining a business which no doubt could be built into a constantly growing enterprise. Next in importance to the goods carried in the store, which of course should be of real quality, comes the salesman and almost as much devolves upon him in making the venture a success as the quality of the goods.

Something for Nothing

Furnishing Radio Entertainment Is Very Desirable

A certain percentage of people are on the alert to get something for nothing. Whatever it is and how trifling it may be is a matter entirely foreign. As long as it is for nothing it is desired. Puzzles and contests have brought many additional dollars into the cash registers of retail storekeepers, but it is proper to make these contests interesting.

The picture puzzle has been successful on many occasions. This consists of a picture preceded by a word out of which the student is requested to form a single connected sentence. Cards are given out in the store and the many ridiculous answers received in reply are amusing.

The best contests are those which require little thinking to bring them to a conclusion. Most persons do not care to spend many minutes or even hours in solving some tricks upon which a thousand other persons are working.

A simple arrangement effective every fall is to offer a prize to the persons who can guess the name of the
(Continued on page 68)

Who Owns This Name?

Confusing Trade Marks of Light Value

By CHAUNCEY P. CARTER

In a recent issue, we called attention to the disadvantages in choosing as a trade-name for radio goods a simple combination of commonly-used radio terms. No better example of the difficulties that may arise therefrom can be found than the following aggregation of claims to combinations of the word "air" and the abbreviation "phone":

AEROFONE—claimed by the Prometheus Electric Company, of New York, N. Y.

AEROPHONE—claimed by Essex Specialty Co., Berkeley Heights, N. J.

AIRFONE—claimed by Laurence Radio-Electric Co., of 854 Locust St., Cincinnati, O.

AIROPHONE—claimed by A. W. Bowman & Co., of Cambridge, Mass.

AIR-O-PHONE—claimed by Air-O-Phone Corp., of New York, N. Y.

It is understood that **AIRPHONE** is also claimed by another manufacturer.

Certainly, confusion is bound to result from the contemporaneous use of these various arrangements of these common elements but as to whether any one of these claimants is in a position to enjoin the others has not yet been decided.

It is just such situations as this that **THE RADIO DEALER** aims to guard against by providing a **COMPLETE** and **UP-TO-DATE** record of all radio trade-marks in use. Those contemplating the adoption of a trade-mark should certainly have the records of this Bureau searched before proceeding to spend any money on the mark, and those who are already using a valid trade-mark should not fail to put the same on record in this Bureau where it may be found by those who seek novel trade-marks from time to time.

NEW RADIO PAINT

A new finish for electrical and radio apparatus is announced by the Chemical Products division of the Du Pont Co., Wilmington, Del. Known by the name of "Viscolac" this material is said to be water proof and has exceptional insulation qualities. Its use for radio cabinets, etc., should improve the appearance and efficiency with no increase in cost and little or no change in the process of application.



New ABC Tuner No. 5750—a dependable apparatus that meets the big demand for a quality tuner at a very low price.

The Ideal Tuner for Popular Broadcast Reception

AN intimate and extensive experience with the conditions that make for real use and enjoyment of radio programs, has produced the new ABC Tuner No. 5750, as illustrated.

This inexpensive yet expert tuner is constructed especially for receiving broadcasting sent out on 360 meter wavelength—the popular demand now, and in the future.

The ABC Tuner is compact, accurate, selective, and comes complete in beautiful kodak-finish cabinet, making one more of the well known ABC Standardized Radio Sectional Receiving Units.

The perfect hookup of ABC Units is illustrated below. Send today for full information about ABC Units and Parts, and how we help you sell them.

Jewett Manufacturing Corp.

342 Madison Ave., (Dept. F.) New York City

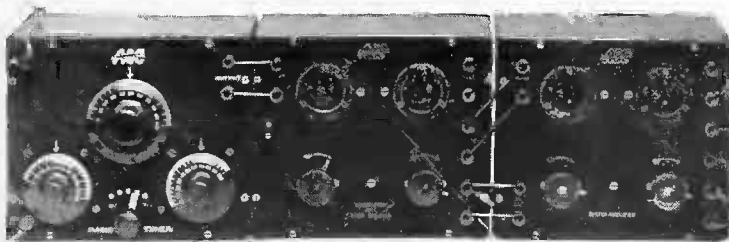

ABC Radio Tuner No. 5750

ABC Detector and One Step Amplifier No. 5013

ABC Two Step Amplifier No. 5014



ABC Loud-speaker No. 5500

Interviewing Marshall Beymer

Manager of New Haven Radio Company Talks in Practical Manner About Radio Industry and Radio Days to Come

AN INTERVIEW WITH MARSHALL BEYMER

MANAGER OF THE NEW HAVEN RADIO COMPANY, NEW HAVEN, CONN.

By N. BEESEY

Many men in the radio industry are students of the industry from a technical standpoint and some are watching the many business activities of the leading manufacturers, jobbers and retailers.

Some of our business men learn by observation and apply their knowledge in a practical way, and it is the thought of Marshall Beymer, manager of the New Haven Radio Company, that the radio industry will be "in better hands" in days soon to come, meaning that the business will be entirely in the hands of modern business men, applying modern merchandising methods.

In an exclusive interview with THE RADIO DEALER Mr. Beymer says:

"While radio, as the child of wireless, is not really new, yet it came so fast when it did finally take hold, that the merchandising side of the business was, and is today, in a chaotic condition.

"The hysterical demand or the buying public in the last year and a half, threw the retail dealers entirely off their balance as to methods of getting the greatest and most far-reaching results out of the radio business. This, coupled with the general unsettled business conditions following the war, lends much to be desired from a manufacturer's point of view, as to having before him a stable trade to sell to.

"One outcome of the hysterical demand was to create what may be characterized as 'Bootlegging Radio Dealers,' who were in the market to turn over as much money as they could while the demand was on, and unload most anything they could get their hands on, at a high price, and get out of the game. Along this line here are two experiences, which we had with retail dealers, which illustrate a condition which is passing, we are glad to say.

"A certain dealer, now out of business, in New York City, heard that we were making variable condensers, and bothered us to death to accept an order for half a million condensers (or as they expressed it, 'something that looks like a variable condenser'), and because we refused the



MARSHALL BEYMER
New Haven Radio Co.

order, they getting the impression that we did not have enough money to undertake such an enterprise, offered to advance us funds for the purpose."

Mr. Beymer started to smile at this moment and the writer smiled, too—but we doubt whether the New York retailer who wanted this order filled ever will realize that the New Haven Radio Company laughed at his order. They are not of the type to produce "something like" apparatus.

"Recently," continued the New Haven radio man, "in a large Eastern city, a retailer confessed he had on hand 250 variable condensers that were no good.

"This confession was brought about because a customer had come to the store with one of the condensers and wanted his money back, because he claimed that it would not work. I asked the dealer what he was going to do with his condensers, commenting, 'I guess you will have to throw them away.' 'Oh, no,' he said, 'I purpose to make a price on them, and get rid of them.' My later comment was that he would simply create 250 dissatisfied

potential radio buyers, and it would eventually work him a hardship. He said he would take his chance on that, as he could get away with most anything.

"This is a condition which will gradually be 'washed out' as the trade stabilizes, but in view of the fact of the semi-professional advisory capacity the average radio dealer is placed in in negotiating with his customers, and the high confidence a customer is compelled to repose in the dealer, there is a certain kind of professional ethics, such as is undertaken by the average druggist, which must be developed among the trade if the radio business is to be a successful business venture. It does seem to me that it is the duty of the radio publications, who also purpose to stay in the field, to begin an education of the trade in this direction."

Business ethics, Mr. Beymer agrees, will drive the fly-by-nights out of the radio business and most of us have seen this development. The lack of business ethics on the part of any radio dealer works hardships on the legitimate merchants. The public's confidence must be attained.

"One angle from which the legitimate radio magazine should start in assisting to develop the radio business, is the matter of credits.

"Our greatest problem today is the problem of fixing the credits from our many customers. So many new stores are springing up over the country, 98% of them apparently starting on a 'shoe-string,' that we are really put to it to know how to serve the orders that come to us. If we exercise what seems to be ordinary good business methods, in asking them for a statement or references, we get back a hot letter, usually accompanied by a cancellation of the order, and frequently we get no reply whatsoever.

"Owing to the hysterical condition seriously referred to, many manufacturers and jobbers demanded cash in advance on their orders. This was due to two things, apparently: first, the desire to get the goods and make a quick turnover; and second, due to

(Continued on page 119)

Two Radio Shows

Greater Cincinnati to Stage Two Shows in October

Greater Cincinnati is to have two radio expositions in October, and according to present indications, both will have a plentiful supply of wireless receiving sets and parts on display.

The first of the two will be conducted at Music Hall, and will be known as the Cincinnati Radio and Electrical Exposition. This will open on October second and close on the night of the seventh. The second show will be conducted under the name of the Tri-State Tobacco Fair and Fall Festival and will open on October 21 and close on the night of the 28th. This will be held in an enormous warehouse in Covington, Kentucky, directly across the Ohio river from Cincinnati.

The Covington exposition will be opened by President Warren G. Harding, who has promised either to be there in person or to deliver the inaugural address by wireless, to be picked up and amplified by radio exhibitors. Governors of Ohio, Kentucky, Indiana and West Virginia have promised to be present, and will deliver addresses. It is expected by the managers of the exposition that at least 100,000 persons will attend the show.

The Music Hall exposition will embrace exhibits, contests and entertainments more diversified and extensive than ever previously undertaken in this city. Everything electrical will be shown, including devices for communication, notification and safety warnings, but particularly specializing in appliances for household use and radio equipment.

TELEPHONE AS AERIAL

The Products Distributing Corporation of New York City has placed on the market a new attachment which eliminates the use of an inside or outside aerial, according to a recent circular. This attachment is novel in that it can be attached to a telephone instrument as well as the light socket. The Presto Aerial Superseder as the attachment is named, is adjustable to suit the wiring of any house. There are seven adjustments. The company also claims that good results have been obtained without the use of a ground.

RADIO CHAIN STORE CO.

The Radio Chain Store Co. has been incorporated, with a capitalization of \$125,000, by Leon Abrams, Abraham Young, New York, and Maurice Abrams, Newark, N. J.

The NEW
**ATWATER
KENT**

2-STAGE AMPLIFIER



Price \$16⁰⁰

THE OUTSTANDING *Advantages* OF THIS INSTRUMENT are

- § Excellence of reproduction.
- § Amplification regulation by small steps.
- § A complete instrument in itself.
- § Compactness.
- § Regulation entirely by knob, no jacks to equip.
- § Transformers protected by steel housing.
- § Short wiring connections eliminate capacity effect.
- § Hermetically sealed, absolutely no moisture troubles.

THE LOW PRICE IS MADE POSSIBLE AS A RESULT OF
20 YEARS' EXPERIENCE IN QUANTITY MANUFACTURE
OF SCIENTIFIC ELECTRICAL INSTRUMENTS

An Excellent Merchandising Proposition

ATWATER KENT MANUFACTURING COMPANY
4941 STENTON AVE. Radio Department PHILADELPHIA, PA.



**Worth More, Yet
Costs Less**

Perfection in Performance and Appearance. "True-Tone" Phones embody every factor of Scientific Design and Construction.

Backed By a Real Guarantee

3000 Ohm Resistance
Maximum Wire Turns
Super-Strength Magnets
of Tungsten Steel

\$5.00
List
3000 Ohms

"True-Tone" Phones—Just what the name implies. *Clear* and *Loud* with all types of sets and loud speakers.

**Jobbers—Dealers: Write or Wire
NOW**

"TRUE-TONE" RADIO MFG. CO.
186 No. La Salle Ave., CHICAGO, ILL.



**Dealers All Over the
Country Handle Our
STANDARD
RADIO GOODS**

**OUR TRADE PRICES
AFFORD GOOD MARGIN**

*Write for catalogue
and price list*

**WIENER WIRELESS
SPECIALTY COMPANY**
21 ACADEMY ST.
NEWARK NEW JERSEY

Adjustable Phones

Standard Electric Sales Co., Bring Out New Phone

The Standard Electric Mfg. Co., who have specialized in the perfection and manufacture of electrical measuring instruments for the past fifteen years, have come forward with a phone that bids fair to upset all production records. The phone was designed by their Mr. Broggar, who is responsible for the wonderful success of the Standard Ammeter, known all over the world.

The feature that puts this phone in a class distinctly its own is the adjustable pole pieces, which, according to the makers, have been tested by the best radio engineers and is claimed as the nearest approach to phone perfection possible.

Heretofore, it has been next to impossible to use a phone unless specially constructed for the heavy stages of amplification without diaphragm rattles that are most discouraging and annoying.

This phone was brought out to supply demand for a phone that will work equally well on crystal sets and several stages of amplification.

This is only possible with a phone with adjustable pole pieces so that the poles can be either moved to the diaphragm or away, depending on the volume of amplification, or sensitivity.

The pole pieces are made of laminated iron, having four doubled laminations to each pole piece, which allows them to store a greater magnetic force than has heretofore been possible with the solid pole pieces.

The selling organization of the factory is the Standard Electric Sales Co., located in offices at 843 Broad street, Newark, N. J.

The men behind this sales force are Henry Bender of Newark, N. J., who has long been identified in the sales and refining of precious metals, and C. E. Godley of the same city, who spent years with the Marconi Co. when wireless was in its infancy. Both these men are the kind that do not make promises that cannot be kept, and are putting the Standard phone on a sales basis that is only enjoyed by companies that have long been in the business and have done all in their power to maintain principles that insure the protection of the distributor, jobber and dealer, and last, but not least, the consumer.

A great number of phones have been placed on the market at a high list price in order to give the dealer a long discount, and in the end the majority do not take advantage of it and the result is that these phones are

DEALER SECURITY

When the dealer buys, he must know he is getting goods which will give his customers complete satisfaction.

Write for details on the Aerovox line—radio equipment that satisfies. We are supplying our dealers with complete Armstrong Super Regenerative Booklets for distribution.

The new circuit will increase the sale of Duo-Lateral Honeycomb and Remler Coils, 12,000 ohms resistance and 100 mil-henry iron core choke coils.

We have this material ready for immediate shipment. Write for prices and Armstrong Regenerative wiring diagrams.

BRADY
ELECTRIC MFG. CO.
PITTSBURGH, PENNA. U.S.A.
415 S. Highland Ave.

JOBBERS—DEALERS

Your profits are to a great extent determined by the class of merchandise you handle.

The more experienced amateurs and broadcast enthusiasts are demanding a condenser of *wider range, greater selectivity* and *absolute stability*.

THE MICRODENSER

is the only VARIABLE DIALECTRIC condenser with a *VERNIER ADJUSTMENT*.

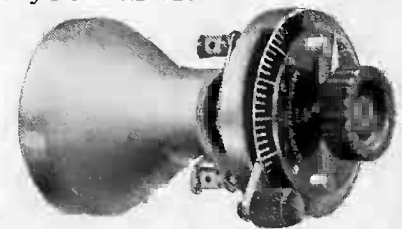

PRICE \$7.50
(Canada \$10.00)

Super-Regenerative Circuit showing use of Microdensers. Price 50c.

R. S. Latest Type Fixed Condenser
.001 Phone Condenser..... .35
.00025 Grid Condenser..... .35
.00025 Grid Condenser and Leak..... .50

Write for Literature and Discounts

THE RADIO SHOP
242 W. Adams Ave., Dept. 100, Detroit
Canadian Dist., Potvin, Herber & Potvin
264 Curry Ave., Windsor, Ont.

to be had at almost any price, depending on the amount and kind of competition, which is a very demoralizing condition.

The Standard electric phone was placed on the market at a fair price with fair discounts and the makers look to the legitimate merchant for support in upholding this principle.

Enters Radio Field

Advance Metal Stamping Co. Bring Out Line

The Advance Metal Stamping Co. 19 Thompson Street, New York City, announce their entry into the radio field catering to the jobber and dealer. This policy was decided upon by the company after one year of manufacturing radio instruments under contract for several nationally known concerns; for one of these firms alone, they have made and delivered approximately 100,000 special rheostats practically without a single complaint.

With their expert knowledge and experience, they feel confident that they are about to fill a want in the radio merchandising field by combining their engineering knowledge with that of their recently installed sales department which is now under expert leadership.

The Advance Metal Stamping Co. is already in production on the following Amsco Products: Filament rheostats, variable condensers and the already famous Amsco Potentiometer. All of these products have been tested for their various capacities and have the approval of the countries leading dealers and the makers invite comparison with all competitive products.

Condensite is used throughout wherever insulation is necessary and the company has prepared a leaflet entitled "Why We Use Condensite" that they will mail to any dealer upon request. It tells an interesting story.

The company's defined policy summed up in a few words is: "Only the best for the trade coupled with intelligent distribution and with a livable discount to all."

THE MARSHALL IDEA

The Marshall Variable Condenser, sold in knockdown form by the New Haven Radio Company of New Haven, Conn., can be purchased in sets of from 3 to 67 plates. This permits the individual to assemble a condenser suitable to his particular set. The company also furnishes the condenser assembled.

THE MARK OF QUALITY

"REGAL" No. 80 Variable CONDENSER Precision Built



43 Plate, .001-MF.....\$4.50
 23 " .0005-MF..... 3.50
 11 " .00025-MF..... 3.00
 3 " Vernier..... 2.50
 Knob and Dial.....\$1.00 extra

"REGAL" MOULDED TUBE SOCKET—No. 205



A fine moulded Socket—different from others. Popular with all radio operators.
 Price\$0.75

"REGAL" TELEPHONE CONNECTOR—No. 162



Does away with all Binding Posts. Permits use of three sets of phones. Only two connections to be wired.
 For Panel Mounting.....\$1.50
 With Plug as shown..... 2.50

Jobbers and Dealers are making real money selling "REGAL" Quality Radio Products. The reason—Precision Made Instruments Honestly Priced and Guaranteed. Send for our handsome new Catalog No. 10 showing our full line.

"REGAL" INDUCTANCE SWITCH—No. 164

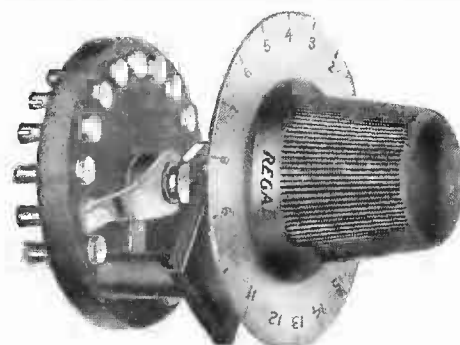

15 point switch complete in one unit. Does away with all switch points. Requires but one hole to mount on panel. BIGGEST HIT IN RADIO.

Price (complete with Knob and Dial).....\$2.00

"REGAL" FILAMENT RHEOSTAT—No. 140



HANDSOME—EFFICIENT—SCIENTIFIC

Exposed resistance wire, giving smooth working, even tension control at all times. 6 Ohms—2-2 Amperes. Ask any radio engineer.

Price (complete with Knob).....\$1.25

"REGAL" VARIO COUPLER—No. 165

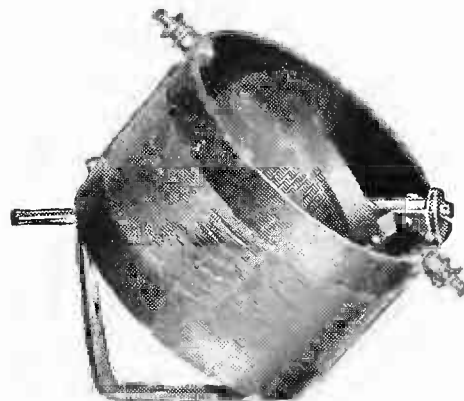

Precision wound—perfect alignment and positive contact. A wonderfully efficient instrument.

Price\$5.00

Home of "REGAL" Radio Products

We still have some territory open for distributors.

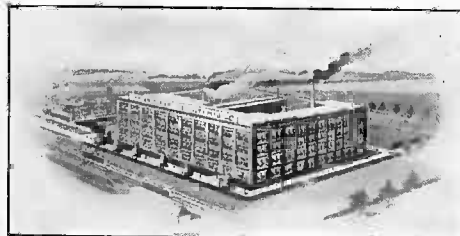

Our co-operation with our jobbers, dealers and distributors is the talk of the trade.

THE AMERICAN SPECIALTY MFG. COMPANY—BRIDGEPORT, CONN.

THE CONQUEROR

FINEST QUALITY PARTS

HIGHEST STANDARD
WORKMANSHIP

BEST GRADE MATERIALS



A CUSTOM BUILT RECEIVER

Built UP to a standard—not DOWN to a price

Built sturdily for endurance,
Handsomely finished for appearance,
Scientifically constructed for maximum efficiency.

EXTERIOR SUPERIORITY

Handsomely finished solid mahogany, hand-rubbed, nickel trimmed. Tuner, detector and two stages of amplification in one compact case—panel $7\frac{1}{2}$ x 15 inches.

OPERATING SUPERIORITY

Wave range—150 to 15,000 meters. Potentiometer with fine control of detector plate voltage. Transformers, maximum amplification without distortion.

No manufacturer can make a better receiving set than the CONQUEROR. No dealer can sell a better receiver than the Conqueror, and no radio fan can buy a better set than the Conqueror. For the full facts and a proposition on which you will want to "go" at once, address—

Lewis & DeRoy Radio Corporation

Manufacturers of
CONQUEROR
PRODUCTS



560 Seventh Avenue
NEW YORK CITY
PHONE BRYANT 7759

Power Via Radio

Radio May Run Big Factories

Dr. Steinmetz, of the General Electric Company, delivered the below remarks to the recent International Radio Congress at Chicago:

There may be a time when power to turn the wheels of industry will be furnished by radio. In some respects radio power transmission exists to-day, for the message you receive by radio has been carried by the power of electro-magnetic waves from the sending to the receiving station.

The problem of power transmission essentially differs from that of the transmission for communication in that in power transmission most, or at least a large part, of the power sent out by the generating station must arrive at the receiving station to make it economical to transmit the power.

Hence the problem of radio power transmission is that of directing the radio waves so closely that a large part of their power remains together, so as to be picked up by the receiving station. Much successful work has been done in directing radio waves, and, for instance, our transatlantic stations send out most of their power eastward.

But still, even as directed, the power scatters over the coasts of Europe from Norway to Spain, so that it is impossible to pick up an appreciable part of it.

The second possibility of radio power transmission—at least theoretically—is by resonant vibration of standing waves.

A station tuned for the same wave length as the sending station would resonate with the standing electro-magnetic wave issuing from the sending station, thereby stopping its passage by absorbing its energy. It would, as we may say, punch a hole in the standing wave sheet coming from the sending station. Power would then flow into this hole; the sending station would begin to send out additional power to maintain the wave sheet.

THE TRADE PRESS

By EDWARD L. BERNAYS

Trade publications are an important factor in building up the devotion of individuals in an industry to that industry, and they are also factors in helping an industry to progress by acting as an information bureau for that industry.

THE-ONLY-KNOB-AND-DIAL-WITHOUT-A-SET-SCREW

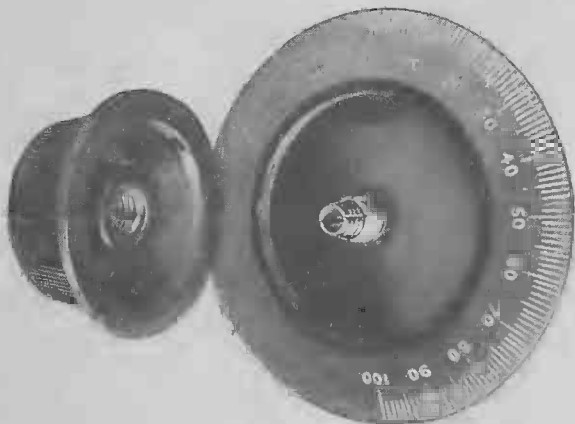

Patented June 20, 1922

The unsightly and troublesome SET-SCREW is at last eliminated. No more loosening of dials, splitting the head of the set-screw, or stripping of threads, perhaps ruining the dials.

To mount the TAIT KNOB AND DIAL simply hold the dial with one hand and screw on the knob with the other; a few seconds does it. No tools are necessary; when fastened it will not wobble on the shaft, at the same time being self centering and self aligning numerals at correct angle for the best visibility.

This beautifully patterned KNOB AND DIAL is made of the best grade of BAKELITE.

MANUFACTURERS—It will greatly beautify your receiving sets, also reduce your labor costs in assembly.

JOBBERs—This product is merchandized to the trade strictly through you. It sells on sight and is revolutionary in its field.

Dealers—write us and we will notify you of nearest jobber

Write us for free sample and discounts

TAIT-KNOB-AND-DIAL-CO.

MANUFACTURERS

11 EAST 42nd STREET

PHONE MURRAY HILL 0341

NEW YORK

Adjustable Coil Mountings for Armstrong's Super-Regenerative Circuit

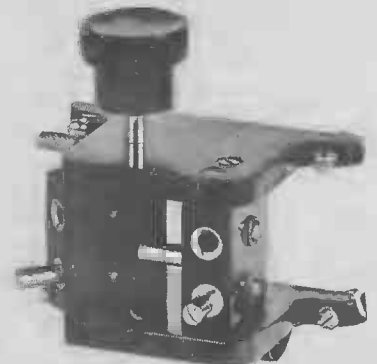
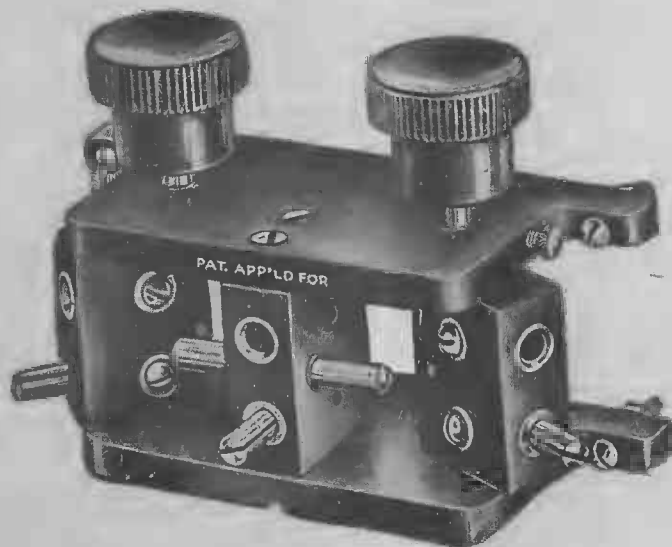

The New Triple Coil Mounting with the following features:

- 1—A patented feature; locks the coil in place. This prevents the coil from being thrown out of adjustment once the station is tuned in.
 - 2—The simplest mounting to install on your set. No rear mounting. Mounts on front of panel.
 - 3—The tension on specially constructed bearings is adjustable.
 - 4—Constructed of the highest grade of insulation material.
- Its high polish and fine finish give it a very attractive appearance. All metal parts heavily nickel plated. Not a moulded affair.

Single and Double Coil mountings adapted for use with the new Armstrong super-regenerative circuits. These mountings are adjustable. Made of genuine Formica, with high polish and fine finish. All metal parts heavily nickel plated. Not a moulded affair.

The Unbreakable Dial

- Triple Coil Mounting, List Price.....\$5.00
 - Two Coil Mounting, List Price..... 3.50
 - Single Coil Mounting, List Price..... .55
 - 3" UNBREAKABLE Dial, List Price..... .70
 - 3½" UNBREAKABLE Dial, List Price.... .90
 - Amco Radio Plug, List Price..... 1.00
- Our production is large and your orders will receive immediate attention.



Jobbers write for special discount

ASTORLOID MFG. CO., INC.

416 Marcy Ave., Brooklyn

Will You Be A Pall Bearer For The Goods You Carry?

ALREADY many of the mushroom variety of radio parts and supplies have fallen by the wayside, victims of public condemnation. The radio business is too good a thing to be killed off by cheap or unqualified apparatus.

Remember, the batteries you sell are judged more critically than any other device because they have a definite life and service-performance to uphold. Consider *quality* first; then *price*. And, if you can get a good proposition on both so much the better. You can do this with

Quality

Each individual cell used in the Ace Battery has a higher capacity than any other cell on the market. The sealing compound cannot bulge because there is an air gap between the top of the cells and the sealing compound itself. This allows the gases to escape. The special wing nut terminals hold so securely that there is not the least vibration, insuring reception of quiet messages. Longer Life is a **FACT**

ACE WIRELESS BATTERIES

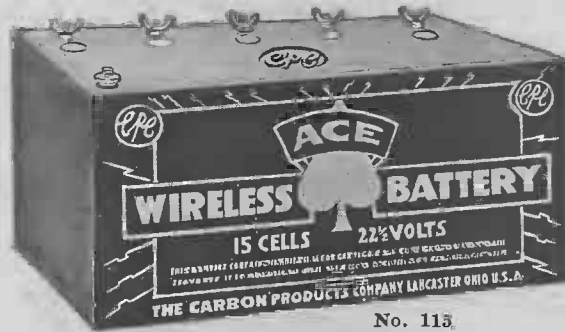

No. 115

Prices

Comparison with other high class batteries will show that Ace offers exceptionally low prices:

Type	List
315 Small portable, 22 1/2 volts.....	\$1.75
115 Variable type, 16 1/2 to 22 volts..	3.00
127 High voltage, 18 to 40 1/2 volts.....	5.00
172 Long distance, 108 volts.....	15.00

THE CARBON PRODUCTS CO., LANCASTER OHIO

S. & S. VARIOMETER



NOTE THE

*Made of Hardwood
Mahogany Finish
Patent Spring Tension Bearing
All Fittings of Solid Brass
Highly Nickel Polished
Wave-Length Range 160-580 Meters
Ready for Panel Mounting*

SUNDAY & SCHOLTZ CO.
2638 W. Cabot St. Philadelphia, Pa.

The Famous S. & S. Ultra-Selective Tuning-Combination

List Price **\$3.00** Each

Dealers and Jobbers Write for Discount

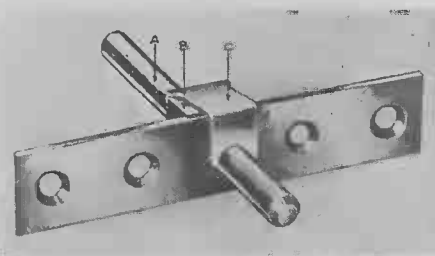

SUPERIOR LINES

*Highly Efficient
Patent Spring Tension Bearings
All Fittings Brass and Nickel Plated
7 Taps of 7 Turns Each
7 Taps of 1 Turn Each
Mounted on Hardwood Base
Ready for Panel Mounting*

Our Unconditional Guarantee Is Behind Each Instrument

S. & S. VARIO-COUPLER



OF CONSTRUCTION

Southern Show

Show at Birmingham, Ala., Big Success

During the week of July 10th to 15th, the first Radio Show to be held in the Southern States was conducted in Birmingham, Alabama. This exhibition, fostered and arranged by the management of the Radio Shop of Loveman Joseph & Loeb, afforded the visitors their first close up of Radio in all forms. The home-made sets comprised a large part of the Show, there being extensive displays of all types of receiving sets, ribbons and money prizes having been awarded owners of such sets as were selected as leaders in their class. In addition to the sections given over to home-made sets, there were a number of displays of improved commercial apparatus in connection with which exhibiting jobbers, manufacturers and engineers were on hand to take care of public inquiry.

An additional feature of the show was broadcasting, one of the sending stations of the Alabama Power Company having been installed for the purpose. Special informative and musical programs were furnished throughout the day and evenings. The show has proved itself the means of bringing radio to the attention of the public more forcibly than heretofore. Attendance increased daily, the last day's attendance having been in excess of 5,000. The benefits accruing have been so manifest that plans for another show, on a decidedly larger scale, are well under way, this to be under the same administration as heretofore. While it will date forward some little time, proposed exhibitors are showing a worth while interest.

CROSLEY'S NEW STATION

The Crosley Manufacturing Company, of Cincinnati, operators of the broadcasting station WLW, is erecting a new station, which will be in operation about September 1st. This will be far more powerful than the one now being used, although the old one is being heard regularly within a radius of 1,500 miles. Four 250 watt tubes will be used.

BRENNAN WITH CARDWELL

The Allen D. Cardwell Manufacturing Corporation of Brooklyn announce the addition to their executive staff of H. A. Brennan as Sales Manager. Mr. Brennan is well known in the trade, having been formerly connected with a well-known New York distributor.

MANUFACTURERS — JOBBERS — DEALERS

PLACE YOUR FALL ORDERS FOR



EBY BINDING POSTS

NOW

Commander "H" Ensign "H"

Sergeant "SS" Buddy

NOTE:—To satisfy the tremendous demands for Eby Posts we want responsible dealers everywhere to carry them. Jobbers! Write for Bulletin 10. Also latest discounts.

THE H. H. EBY MFG. CO., 605 Arch Street Philadelphia, Pa.

MIRACO Radio

Frequency Broadcast Receiver



REPRESENTING THE LATEST DEVELOPMENT IN LONG DISTANCE RADIO RECEIVING SETS

Provides sharper tuning with less controls, eliminates interference and reduces static to a minimum.

AMPLIFIES BEFORE IT DETECTS which makes it capable of bringing in concerts and signals from extremely long distances.

\$45.00 Prepaid, less tubes, phones and batteries.

Send for literature descriptive of this and other "MIRACO" products

DEALERS :

Here is a popular priced, advertised Receiver that will sell quickly. GENEROUS PROFITS. Write for prices, discounts and catalog on the whole MIRACO Line.

MIDWEST RADIO CO. 808 Main Street CINCINNATI, OHIO

The Gelman Plug



The GELMAN UNIVERSAL RADIO PLUG fills a long felt want for a simple substantial plug which can be used with telephone cords having pin tips, spade tips or plain wire ends. ALL METAL PARTS heavily nickel plated. NO SOLDERING NECESSARY. List price, \$1.00.

Manufacturers of

The Gelman 23 and 43 Plate Condensers

Jobbers and Distributors

Write for Our Proposition

S. S. NOVELTY CO.

255 Bowery

New York, N. Y.

100% Radio

Altadena Radio Laboratory

560 E. Colorado Street

Pasadena, Calif.

Jobbers of All Standard Radio Apparatus, including

A-C Electrical Mfg. Company
Acme Apparatus Company
Adams-Morgan Company
American Hard Rubber Company
Automatic Electrical Devices Company
Nathaniel Baldwin, Inc.
L. S. Brach Supply Company
Burgess Battery Company
Blank Radio Call Book
Central Radio Laboratories
Edison Storage Battery Company
Everett Electric Corporation
Federal Telephone & Telegraph Company
General Apparatus Company
General Radio Company
Jewell Electrical Instrument Company
Colin B. Kennedy Company
Magnavox Company
Karlowa Radio Company
Parkin Mfg. Company
Radio Corporation of America
John A. Roblings Sons Company
Splitdorf Electrical Company
Thordarson Electric Mfg. Company
C. D. Tuska Company
Western Electric Company
Westinghouse Electric & Mfg. Company
Weston Electrical Instrument Company
The Wireless Shop

PAUL FRANKLIN JOHNSON

Business Bourse

Live Wire Company Offers High Grade Helps for Executives

A natural result of the mushroom development of radio has been an absence of reliable lists of dealers or jobbers. All the other retailing fields have well-established lists, as a natural result of gradual evolution.

As a consequence, there was no organized and competent source of radio dealer or jobber names available, until recently. Among the new firms furnishing lists appeared The Business Bourse, 15 West 37th Street, New York, who are especially competent to furnish lists because they have for years operated a business research bureau with local correspondents in 173 cities and towns.

No existing list is very perfect, due to the many changes and quick developments. Furthermore, there is still material for controversy as to what constitutes a "radio dealer," to say nothing of manufacturers and jobbers who retail as well. Hardware dealers, jewelers, drug, music, department and auto accessory stores are entering the field, while many small electrical contractor-dealers carry a handful of radio supplies.

The Business Bourse is at work constantly developing its list, both of radio dealers and jobbers; and is offering these lists for sale. Not on a competitive basis but as a quality product.

The Business Bourse has for nearly a year been active in the radio field in a counsel and research capacity, in the development of several important new radio companies. It has given intensive study to the radio merchandizing situation, through its President, J. George Frederick, who is nationally known as a sales analyst, author of "Modern Sales-management," "Business Research and Statistics," etc., and who is treasurer of the New York Salesmanagers' Club. A 100-page typewritten research on radio merchandizing has been prepared and is being sold. As President Frederick says, "If anybody ever needed badly to read and study a sales research report, it is the man or company entering the radio field. It is a new field of business to most, and now cutting its wisdom teeth at a terrific cost, which can be lowered by intelligent research such as used by other sound business houses in much older lines of business."

One of the novel new radio offerings of the Bourse is a handsome broadcasting map.

The Essentials of a Successful Radio Business Are Complete Sets and Phones

We are now making deliveries of

Clapp-Eastham H-R—H-Z.	\$80.00
Grebe CR-9.....	130.00
Grebe CR5-RORK.....	135.00
Westinghouse RC.....	132.50
Westinghouse RA-DA....	138.00
Frost Fones No. 162.....	5.00
Murdock, No. 56, 2000 ohms	5.00

Send for our complete catalog of standard makes of Radio Sets, Parts and Supplies, and Dealers' Discounts. We have a big stock for you to draw from.

Julius Andrae & Sons Co.

In Business Since 1860

—Broadway, Milwaukee, Wis.—

BEFORE you adopt a trade-mark

Have the Radio Dealer Trade-mark Bureau give you a report on its novelty based on registrations in the Patent Office AND IN THE RADIO DEALER TRADE-MARK BUREAU.

AFTER you have adopted a novel trade-mark

Register it at once in the

**RADIO DEALER
TRADE-MARK BUREAU**

4907 Potomac Ave., N. W.
Washington, D. C.

More Business

(Continued from page 33)

suring. Even tho' the immediate profit is slightly less, in the first case, the time required to sell the less acceptable make more than wipes out the difference. Furthermore, the store that specializes in *known, branded, advertised* goods, shares the reputation the manufacturer has built up, and *must* acquire the respect and confidence of the new or prospective customer with no radio experience.

Many radio manufacturers who will do national advertising this fall will also supply you with window displays, counter displays, folders, letters, and other forms of sales promotion, either free or for a nominal charge. A policy of concentration on a relatively small number of makes means that the full use of such material is essential. Do not overlook the selling possibilities of your windows especially. Much of the material advertisers will supply you represents the work of trained specialists and is of a quality whose price would be prohibitive if they were worked out for one individual store. Certainly, it is far more profitable to let this carefully designed material pave the way to sales, than to spend the expensive time of yourself and your salespeople doing the same job. Such selling material identifies your store with the national advertising, and enables you to use already prepared displays, etc., which you have neither the time nor money to prepare individually.

Consider this angle: A customer, contemplating the purchase of a radio outfit or supplies decides to do a little "window shopping." In your competitor's window he sees the miscellaneous "mess" seen so frequently in the windows of radio stores. In your window, he sees a display for a set with which he has already come to know thru' national advertising. *Yours* seems familiar. It almost seems that he is already acquainted with your store. He goes inside and is greeted with a demonstration of the same set. If the salesman is busy, there is a descriptive booklet within easy reach. Can there be any doubt of the effectiveness of such a properly co-ordinated selling plan? It is by so hooking together the different sales angles available that much of the preliminary work is often done automatically.

Furthermore, when it becomes known thruout the community that your store specializes exclusively on *known, advertised, branded*, radio

VERNIER VARIABLE CONDENSER

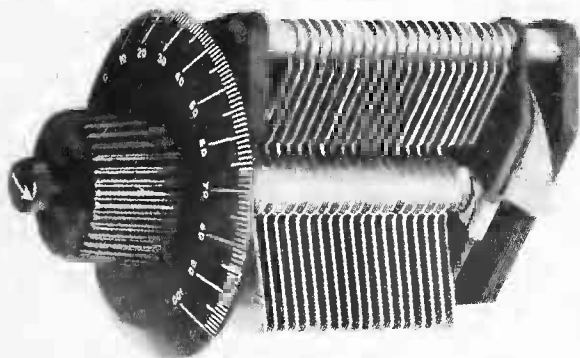

43 Plate
Vernier \$5.50

23 Plate
Vernier \$4.50

With Dial and Knob

JESSER RADIO SALES CO.
538 South Clark St. Chicago, Ill.

Wilcox Standardized Parts

SWITCHES

Beautiful knobs—brass metal parts with polished nickel finish—accurate panel bushing with nut—straight smooth long shaft makes perfect bearing—may be mounted on panel without disassembling. Standard appearance throughout, complete line.

1" Radius Rotary Switch... \$.40
1 1/2" Radius Rotary Switch... .50
Series Parallel Switch... .85
Compound Switch... 1.25

RHEOSTATS

A real bearing—long, large and accurate. 180 degrees movement—sturdily constructed—1/4" shaft with beautiful standard knob and pointer which may be replaced with dial if desired. Perfectly ventilated 6 ohm resistance. Positive stops with all off and all on positions. Nickel-plated metal parts.

Type 123 Rheostat... \$.75

JACKS AND PLUGS

Long, heavy, genuine phosphor-bronze springs on jacks—attractive and convenient adjustable panel bushing. Substantially made and well insulated plugs that will not push or pull apart. Convenient provision for attaching cord. Beautiful design, nicely finished. All metal parts polished nickel.

Jack... \$.80
Plug... .90

VARIOMETERS

Genuine mahogany forms, beautifully finished. Accurate machine and assembly work. Pigtailed connections to rotor. Convenient binding posts. Correctly designed for best results. Also furnished in parts.

Type 5A Variometer... \$5.25
Type 5AP3 Variometer Parts—wound but not assembled 3.00
Type 5AP1 Variometer Parts—wooden parts and winding form only... 2.00

STANDARDIZE ON WILCOX STANDARDIZED PARTS FOR THREE YEARS THE LEADERS IN THE PART FIELD—LIBERAL DISCOUNTS—SEND FOR ILLUSTRATED CATALOG

DIALS

Heavy brilliant white celluloid—jet black engraving—beautiful knob—nickel-plated brass bushing accurately bored for 3/16" or 1/4" shaft. A style and size for every purpose. Graduations 2" diameter, 90 degrees, 180 degrees and 360 degrees. 3" diameter 90 degrees and 180 degrees. 2" diam., \$.50 3" diam., \$.60

SOCKET

Bakelite insulation—ventilated base—mounts any side toward panel or on table or shelf—connection posts at both top and bottom—strong diagonally placed contact—spring of genuine phosphor bronze—attractive appearance.

Type 126 Socket... \$.75

BINDING POSTS

Attractive appearance—superior design—excellent workmanship—popular patterns—polished nickel metal parts.

Type 131A—Moulded cap with one stem and shank... \$.10
Type 131B—Same as above but extra large size... .15
Type 132A—Knurled brass cap... .05
Type 133A—Small pillar type .10
Type 133B—Large pillar type .15

VARIOCOUPERS

Genuine bakelite dilecto stator forms—mahogany rotors—convenient mounting brackets—pigtailed connections to rotors. Furnished in following ways:

Type 1C Variocoupler with two switches, dial and binding posts assembled on 5"x5" grained bakelite panel... \$8.00
Same except panel, not assembled... 4.50
All parts used back of panel completely assembled... 4.00

THE WILCOX LABORATORIES, INC.
LANSING DEPT. MICHIGAN

ELECTRICAL TESTING
of all material entering into Radio Construction. Also Chemical Analyses and Strength Tests.
Bowling Green 7016
New York Testing Laboratories
80 Washington St. New York City

Telephones: 5454 Beekman 2787
NAME PLATE COMPANY
ETCHED OR LITHOGRAPHED METAL
NAME PLATES, SIGNS, DIALS
125 FULTON ST., NEW YORK

PATENT
your ideas. Protect your rights by U. S. and Foreign Patents and Trade-Marks. Moderate rates. CALL, WRITE or send us your invention.
May one of our representatives call on you?
FREE CONSULTATION
Phone: Vanderbilt 7212.
MANUFACTURERS PATENT CO.
520 FIFTH AVE. NEW YORK

SCREW MACHINES IDLE
Battery of Seven Automatic Screw Machines for Making Parts for Radio Equipment.
SEND BLUE PRINTS AND SPECIFY QUANTITY
The Carlyle Johnson Machine Co.
MANCHESTER, CONN.

PAPER TUBES FOR WIRELESS
ALL SIZES ON HAND
FOR IMMEDIATE DELIVERY
WHOLESALE AND RETAIL
BAEHM PAPER CO., Inc.
219 Fulton Street New York
Bet. Church and Greenwich Sts.

PATENTS
on radio inventions apply to
OTTO K. ZWINGENBERGER
38 Park Row, New York
Cortlandt 3207

CAP SCREW AND NUT CO. OF AMERICA
318 West 47th Street New York
Manufacturers of Screws, Bolts, and Nuts of Every Description
In Stock for Immediate Delivery
Switch Stops, Binding Posts, Contact Points

ROCKY MOUNTAIN CRYSTALS
Better Than Galena
The most sensitive mineral rectifier known. Can also be used with one or more stages of amplification.
Mounted 35c. Unmounted 20c. Postpaid
Manufacturers, Jobbers, Dealers, Clubs. Apply for Special Prices.
Rocky Mountain Radio Products, Inc.
9 Church Street, New York, N. Y.

RADIO MAILING LISTS
We have just compiled a list of 6,900 Radio Dealers (none worth less than \$3,000) covering the United States.
707 Radio Manufacturers Price per M. \$7.50
726 Radio Supply Jobbers..... " " " 7.50
260 Owners of Radio Stations..... " " " 4.00
14,000 Radio Amateurs and Managers of Radio Stations..... Price per M. 7.50
Neatly typewritten and ready to send on receipt of remittance covering the amount.
TRADE CIRCULAR ADDRESSING CO.
166 West Adams Street Chicago, Illinois
Franklin 1182-1183

products, backed by intelligent service, the last vestige of any lack of confidence must disappear. Such a reputation will be far more effective from a sales viewpoint than cut prices on unknown merchandise.

If your own advertising also brings out this policy, prospective buyers of radio goods will look to your store as a safe place to buy. This is what is needed to break down the widespread public feeling of uncertainty toward radio. It will benefit your store directly as well as the industry in general.

In conclusion, let us sum up the particular advantages of applying a policy of concentration on a few well advertised lines:

For one thing this shifts the responsibility for performance to the manufacturer. And surely any maker who brands his product, and turns the pitiless light of publicity on it, *must make good!*

The increased turnover, and the advantage of doing an equal or larger volume of business, on a small carefully selected stock, with larger orders (and consequently larger discounts) on individual items will unquestionably make up for the slightly smaller margin which in some cases may be necessary.

Even if you still happen to accumulate some items, a cut price on an advertised "known-priced" article is a real attraction.

Finally, by co-operating fully with the different advertising campaigns, you can materially help to strengthen the position of the entire industry, as well as your individual reputation.

STUDY OF LIGHTNING

C. T. R. Wilson of Cambridge University is the author of the only decent theory of thunderstorms ever made. His estimates are rather of a billion than a million volts for a flash, and he shows that there is enough horsepower in the falling rain to provide it. Professor John Trowbridge of Harvard had thirty years ago a storage battery of forty thousand volts and a condenser like that of the "Wizard" Steinmetz, with which he made similar lightning. But Harvard is an institution of learning, and not an advertising bureau, and the names of the men that use this battery in the great Cruft laboratory are not in the papers.

ARTHUR GORDON WEBSTER,
Clark University, Department of Physics, Worcester, Mass.,
New York, July 22, 1922.

Want to Buy?
Ask Our Service Bureau.

Buy Apparatus
From a Reliable Manufacturer
FREED-EISEMANN RADIO CORP.
255 Madison Ave., New York City

Radak
Reg. U. S. Pat. Off.
RELIABLE RADIO EQUIPMENT
made by America's oldest and largest manufacturers of radio equipment exclusively. Sold by the best electrical and radio dealers.
CLAPP-EASTHAM CO.
133 Main Street Cambridge, Mass.

MANUFACTURERS OF
Receiving Sets Complete
Unites Mounted and Unmounted
Send for Description and Prices
RADIO OUTFITTING CORP.
Mfg. High Grade Radio Apparatus
410-412 East 34th St. New York, N. Y.

The Sign of **QUALITY-PLUS** Instruments
ARROW RADIO CO.
Mrs. of Quality-Plus Instruments
Hackensack New Jersey

P. D. JACKSON
Direct Factory Representative
Radio Equipment Manufacturers
HEAD SETS A SPECIALTY
1441 So. State Street Chicago, Ill.

AEREX King of the Air
COMBINATION RECEIVING SET
CRYSTAL-DETECTOR-TWO STEP
Aerex Radiophone Corporation
342 MADISON AVENUE, New York City

Fine Cuts for Illustrating
CENTRAL ELECTROTYPE FOUNDRY COMPANY
Electrotyping and Engravings
9 Campbell Street Newark, N. J.
Telephone: Mulberry 1698

RECEIVERS REWOUND AND REPAIRED
Any make, copper wire, any resistance Work guaranteed
Commissions to Dealers
MONTCLAIR RADIO CO.
272 Bloomfield Avenue Montclair, N. J.



Real Apparatus
Popular Prices
Good Discounts
Prompt Deliveries
Package Packed
P. E. Edelman, E.E. Mfr.
9 Church Street
New York, N. Y.

Choosing Head Sets

(Continued from page 35)

tested for sensitiveness. This test requires the services of a highly-experienced tester who compares the sounds emitted by each receiver with a standard receiver. While undergoing this test, the receivers are also matched in tone, so that both receivers on any one head set will respond in exactly the same manner to various frequencies.

While the best head sets for radio work are rugged in construction and will stand up under hard usage and varying weather conditions, they should be given ordinary care at least. In other words, no receiver will be improved by dropping it on the floor or by rough handling and moreover such treatment may result in a loss of a certain amount of magnetism. In removing the cap from the receiver, care should be taken not to bend the diaphragm. In fact, it is best not to open up the telephone receiver under any circumstances. With fair treatment a good head set should outlast any other part of the radio receiving outfit.

It is evident from a resume of the above stated facts concerning telephone head sets that the use of an inferior head set may result in the rejection by the public of a radio receiving set which in other respects is faultless. Therefore, it is up to the radio manufacturer, the jobber and the dealer in the interests of the radio industry to strongly insist that head sets meant for use with radio equipment be of the highest quality obtainable.

SCHWAB'S NEW CATALOG

Six types of variable condensers are listed under the Drisco line in the new catalog recently issued by Harold M. Schwab, Inc., of 419 West 42nd Street, New York. This firm is the sole factory distributor for Drisco Radio products.

Other Drisco specialties are the Drisco Radiometer, panel switches, potentiometers, rheostats, tuning coils, variometers, and fixed condensers. The Drisco laboratories are equipped both for the assembly of radio instruments and for other processes in manufacture, such as nickeling, dye-making, stamping, plating and the like. All work is done under the supervision of L. H. Baier, radio engineer and technical expert, with John L. Slane as assistant.

Among other items listed in the Schwab catalog are Turney head sets and the Schwab brand of dials, tube sockets, binding posts and switch levers.

STOP-LOOK-WRITE

DEALERS, JOBBERS AND MANUFACTURERS

Before placing orders, write us first and get samples and our big discount sheet.

	List	List	
Condensers 43-Plate.....	\$3.50	Turney Head Sets.....	\$6.50
" 23- "	2.75	Dials 3"75
" 11- "	2.25	Variometers	3.50
" 7- "	2.00	Variocouplers	3.50
" 3- "	1.50		

SPIRO BROTHERS, Manufacturers and Distributors
519 Real Estate Trust Building Philadelphia, Pa.

WALD ELECTRIC COMPANY

Manufacturers

"MICROSTAT"

A VERNIER THROUGHOUT ITS RANGE

INDISPENSABLE FOR NEW ARMSTRONG-SUPER-REGENERATIVE CIRCUIT, WILL ELIMINATE NOISES USUALLY MISTAKEN FOR STATIC

7 OHMS

2 AMPERES

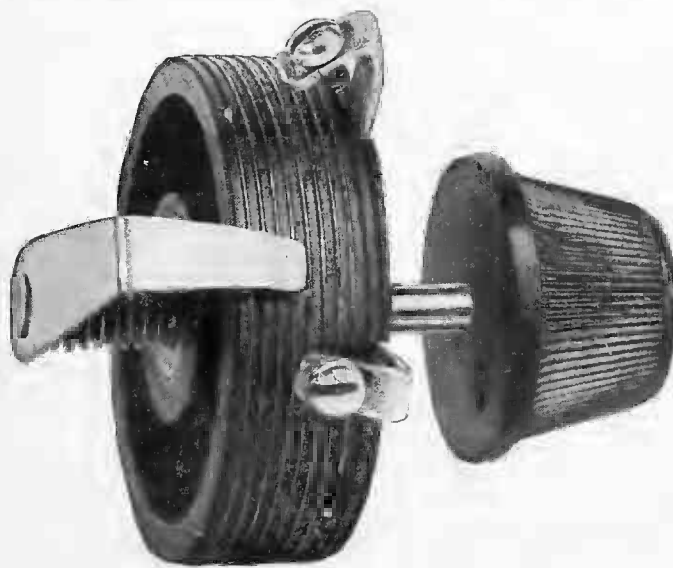

(PATENT PENDING)

STEPLESS
FILAMENT
CONTROL

Price
\$1.50

An Instrument
of Merit

DEALERS AND JOBBERS—WRITE FOR DISCOUNTS
AND LIST OF RADIO PARTS WE MANUFACTURE

Sales Department

LOUIS A. STAFF CO.

1755 Broadway

NEW YORK

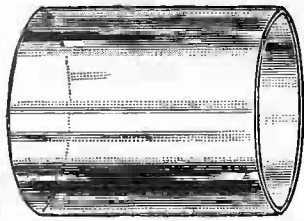

Glass
Tubes
for
Crystal
Detector
Sets

Special Prices in Quantity

Vineland Scientific Glass Co.
New York Office 1133 Broadway
Factory Vineland, N. J.

T-B-H PHONES ANNOUNCEMENT

Our increased production facilities enable us to reduce our phones from \$8.00 to \$7.00 list.

Dealers—Jobbers—Compare the T-B-H at \$7.00 with ANY other priced phone on the market—then you will order ours. T-B-H Phones speak for themselves.

Write for Discounts

T-B-H CORPORATION
Dansville, N. Y., U. S. A.

Solder Your Connections

for best results. Get the "Wonder" a Self Heating Iron. Use it anywhere without stove. No workshop complete without it. Cheap to operate. Generates own vapor in two minutes. Absolutely safe—a child can operate. Nothing to get out of order. Use it as a blow torch also. Boxed complete with solder, salamoniac and full soldering directions. Send No Money—just your name and address on a post card. When the postman delivers, pay him \$2.50.

Dealers—a big seller, write for proposition.

North Shore Radio Works, Dept. C-601
810 Davis Street, Evanston, Ill.

Ask Our Service Bureau

BRACH VACUUM LIGHTNING ARRESTER

An Instrument That Calls for No
Argument

No need to argue about the merits of this, that, or the other arrester when you can sell the one that has stood up in its commanding position for so many years as the highest development in lightning protective apparatus.

Your customers will not question the Brach Arrester.

Dealers Cannot Afford To Be Without It.



Listed by the Underwriters' Laboratories
Trade Supplied By Best Jobbers
L. S. BRACH MFG. CO., Newark, N. J.
Makers of Solderall, Mends Metals,
Connects Wires.

Coast Representatives—Pacific States Elec.
Co., San Francisco, Los Angeles, Oakland,
Seattle, Portland, Spokane.

Mica Diaphragms

(Continued from page 44)

any pair of head phones to be matched by the user.

The complete micaphone mica diaphragm is unique in that the entire pull of both receiver magnets is transferred to the exact center point of the diaphragm so that a true diaphragm vibration is permitted, sound waves being given off without interference.

We have often been asked how large a diaphragm it is possible to get. The largest we have ever made in commercial quantities is three inches in diameter and about 14 thousandths of an inch thick. It would be possible to make diaphragms in limited quantities twice this size but the cost would be extremely high. The largest feasible size when large quantities is considered is about $2\frac{1}{2}$ to $2\frac{3}{4}$ inches in diameter. Strange to say, however, the diameter of a diaphragm appears to have little effect, if any, on loudness and experts are not agreed as to whether the tone is materially better with a larger than with a smaller diaphragm. In radio receivers at the present time there are thirteen different sizes in use by 55 different manufacturers. The smallest size— $1\frac{3}{4}$ inches—is by far the most popular but even the makers of the small receivers usually also make a larger one—either $2\frac{1}{8}$ or $2\frac{5}{8}$ diaphragm. The German Seibt phone with a diaphragm of $2\frac{3}{8}$ diameter is the largest of the head-set diaphragms but there is a phonograph using $2\frac{9}{16}$ mica diaphragms.

Sheet mica of high grade may be obtained even up to 24 inches long and pieces have been obtained from Madagascar and from Rhodesia up to 28 x 32 of fine clear mica. It is probable that a single diaphragm very thin in thickness might be gotten from one of these sheets.

Very little theory is known concerning diaphragm action and it is largely by constant experimentation that any advance is made. The United States Bureau of Standards are now at work on elaborate methods for testing head sets and among other things have found that no pair of phones can be matched at the factory. They must be matched at the receiver's radio set under the conditions of use. On one well known make of phones tested it was found that if they were perfectly matched at an audio frequency of 1200 cycles they would gradually grow apart as the frequency was lessened until at 500 cycles one phone was twice as loud as the other. That is the reason why we supply a spacing ring with each micaphone mica diaphragm. The user may from time to time adjust his diaphragms. Ulti-

DEALERS: Get our price list before placing your orders

We are distributors of Federal, Pacent, National, Miraco, Uradiola, etc., lines of Quality Radio Apparatus.

The Edw. J. Goetz Co.
604 Race St. Cincinnati, Ohio

1/8 Automatic Screw Machine Products **2**
MERIT MACHINE MFG. CORP.
465 Greenwich Street
New York, N. Y.
Phone CANal 9128
9th Ave. L. Desbrosses St. Station

DEALERS:—

WE are Jobbers for
Grebe Receiving Sets
Murdock Products
Baldwin Phones
Federal, Fada and
Radio Shop Products

Write for Our Special Proposition A

The Radio Shop
OF NEWARK
41 South Orange Ave., Newark, N. J.

**DEPEND ON
CRAMER
RADIO**



**SPECIAL
FOR 30 DAYS**

This \$80 Receiver at 50% Discount

The CH5 receiver needs no introduction. Judged by any standard it is without equal anywhere. Simple in control; handsome in appearance; super-efficient in operation. Includes in its 150 to 3000 meter range, amateur, commercial and Navy waves, special land stations, ship stations and Arlington "time." Employees latest inventions. Especially efficient for radiophone concert reception. Guaranteed in writing for one year. Regular price \$80 with 25% discount—and worth it. **SPECIAL FOR 30 DAYS 50% DISCOUNT.** EVERY DEALER SHOULD HAVE AT LEAST ONE! Send cash only—no CODs or charges. Not more than 6 sold to one dealer.

W. R. CRAMER, DEPT. 3, OMAHA, NEB.
"Pioneer Radio Manufacturers"

mately he will make no changes and after a slight period of use the diaphragms will "wear in" and give a clearness, tone and general audibility that he has never before heard with all harsh sound and interfering noises cut out or softened so they are not noticeable. In tests made in our laboratory we have succeeded in entirely eliminating even the noises due to tube oscillation and hearing the broadcast program perfectly while with metal diaphragms on the same head-set there was a tremendous volume of noise in which it was impossible to distinguish the presence of a program.

NEW VERNIER CONDENSER

The Radio Shop of Detroit, Michigan, has placed on the market a new type of vernier condenser that sells under the trade name of the Microdenser. The Microdenser is built with two surfaces, the shaping of which makes for large capacity in a small space. According to the company's recent circular the Microdenser can be accurately adjusted enabling the operator to tune out undesired noises and signals. Due to the great range and fine adjustment it is possible to use this instrument for various circuits and purposes, making it especially valuable to the experimenter.

The rated capacity of the Microdenser is .001 micro-farads. When used in a vertical position, the base may be filled with oil thereby increasing its capacity several times.

For course adjustment, a lever extending between the dial and cam case operating through an arc of ninety degrees is provided. This lever explores the entire range of the Microdenser rapidly. The finer tuning is made by turning the knob in the centre through an arc of 180 degrees, an adjustment possible at any position of the cam lever.

P. O. USES INDOOR AERIAL

Experiments have convinced Post office radio experts at Washington that the day of the indoor antenna for receiving sets has passed but it does not mean aerial wire, etc., cannot be sold.

According to Superintendent J. C. Edgarton of the radio section the department has been using "large-verticle outside-multiple turn-loops," "underground-horizontal loops" and "underground-antennae" and eliminating much static interference.

"The horizontal buried loop has been very successful," Superintendent Edgarton announced, "when well insulated and buried in water or very damp earth."

NARCO

Variable Condensers

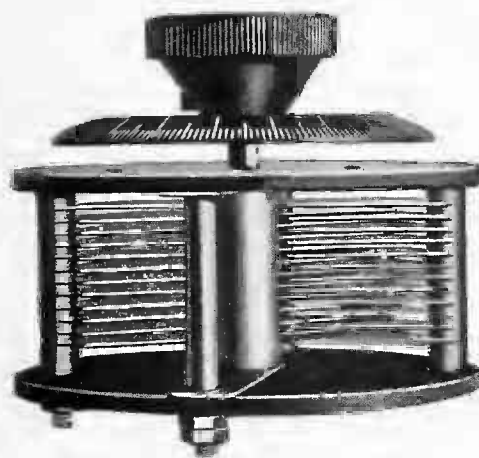

3 Plate - 11 Plate
23 Plate - 43 Plate

With or without Dials.
Write for prices.
We also manufacture
Crystal Detectors,
Tuning or Loading Coils,
Switch Arms and other
Radio Parts.

NORTH AMERICAN RADIO CORPORATION

422 First Ave.,

Pittsburgh, Pa.

DEALERS

MANUFACTURERS

JOBBERS

ATTENTION

We ask you to read the following carefully, and we are sure that you will derive some benefit, both for your customers and yourselves.

We have made an extensive study of Minerals pertaining to Crystal receiving, and from that study and past experience, we know that we are manufacturing as good, if not better, Crystals than any on the market. *UNDERSTAND*, we are not dabbling in other parts pertaining to Radio nor jobbing same, but *SPECIALIZE* in Mounted and Unmounted Galena, Silicon, Radiocite, Zincite, Million Point Crystals and any other kind desired.

We are using only the Genuine Woods Metal in the mounting, because it is the most sensitive made. Woods metal will dissolve in boiling water or 143 degrees temperature, whereas if an alloy is used, as is most generally the case, the dissolving heat runs to 300 degrees. When this metal at such intense heat is poured on the minerals, it burns off most of the real sensitive spots, making the crystal poor value at any price.

We are making as a special, the Adbrin Combo Twin Crystals, which come in the following combinations: Galena and Radiocite, Galena and Silicon, and Galena and Million Point. This crystal has proven a big seller.

We *GUARANTEE* each and every crystal we manufacture, as each one is tested by the broadcast method. We do not depend on the Buzzer Test.

We are in a position to give immediate delivery on any quantity desired, as our production is unlimited.

These crystals are packed in attractive cartons and each kind is in different colored boxes.

There are several territories open for real live wire distributors and we desire to close same as soon as possible.

Full details will be furnished upon request.

ADBRIN LABORATORIES

469 Broad Street

Newark, N. J.



Dealers!
Build Your Profits Around This Idea!

The dealer who appeals to the natural instinct to build and to the universal desire to save money by featuring

MARSHALL VARIABLE CONDENSERS
READY-TO-BUILD

will come in for the certain profits which will come with Christmas business.

Special dealer proposition. Write

NEW HAVEN RADIO COMPANY
441 Chapel St., New Haven, Conn.

RADION HARD RUBBER PANELS
Cut to Any Size
DISCS, WASHERS, BUSHINGS, ETC.
Made to Order
New York Hard Rubber Turning Co.
212 Centre Street, N. Y. C.

Free Will help **YOU** increase sales

This catalog will show you how to secure the names of your best prospective customers, those you want to reach most. Counts and prices are given on thousands of different Lists, covering business concerns, professions and individuals, such as Noodle Manufacturers, Druggists, Coal Mines, Farmers, etc. Personalized sales letters and descriptive literature mailed to live prospects will increase your sales by creating direct orders or inquiries.

99% Guaranteed Mailing Lists backed by our 5¢ refund

Insure your getting up-to-date information, for our Lists must be compiled from latest sources to avoid heavy losses through the guarantee.

Send for FREE Reference Book today
A postcard will bring this valuable sales help.
ROSS-GOULD CO., N. 10th, St. Louis.

Ross-Gould Mailing Lists St. Louis

Stanton's WIRELESS Bulletin



FRANK T. STANTON & CO.
STOCK SPECIALISTS

The Authority on Wireless Stocks

Reynolds Spring Co.
Radio Corp. of America Spanish Marconi
American Marconi Canadian Marconi
English Marconi Federal Tel. & Tel.
De Forest Radio Tel. & Tel.

FRANK T. STANTON & CO.
Broad 5819 35 Broad St., N. Y. C.

Valuable Advertising

(Continued from page 40)

business in this way can feel that new customers will be attracted by the sign.

Little dealers who do business of a humble nature may well sacrifice dignity some times to obtain notoriety.

A Brooklyn printer who inherited the rather positive name of Kick, takes advantage of the coincidence on his sign which is lettered "Kick the Printer."

For the merchants of the higher grade there are words which can be selected that are of a refined meaning. "Electrical Apparatus For Men Who Know." "Radio of Quality," "The Store of Distinctiveness," and numerous other phrases can be hit upon. "The Radio Shop" has a proper significance if you are the first in your town to use it. A catchy and exclusive name is always of value, if it is such a name that will become popular on the tongues of the multitude. "The Hattery" is a distinctive name that has value as a trade mark, though the "Shirtery," as one haberdasher puts it, is an illustration of how near the border line of vulgarity we are. "The House That Will Help You," is a catchy phrase used by one manufacturing enterprise.

"The Gear to wear and tear" is an expressive term which a motor boat manufacturer contributed to trade literature. "We bank on quality" is an expression that can be applied to almost any business. "The Wireless Shop" is distinctive. "The house with open business methods" is a stereotyped phrase that one successful concern resorted to on its signs. The word "pioneer" is always of value to those concerns who have blazed the way in their industry, and there are various ways that it can be arranged. "We aim to please" is a phrase that has now become but a little too common. "Guaranteed Radio Equipment" is a phrase that will arouse confidence.

In high-grade lines of business elegant language and fancy letters are as essential in sign making of every description. If a dealer happens to be located in a college seat, it is manifestly to his advantage to make capital out of various emblems that signify the college. The Yale Mixture for tobacco, the Yale hat, the Yale pipe, shirt, shoes, gloves, canes, canoes, clothes, stationery etc., are terms that have proved a valuable asset to New Haven business men, and Cambridge, New York, Dartmouth, and other cities that harbor great educational institutions take advantage of the same opportunities.

SHIPPED FROM STOCK



Prices Net to Dealers Only

Variometer, complete \$2.00
Variometer Parts, all necessary parts except wire..... 1.00
Variocoupler, complete 1.50
Variocoupler Parts, complete set of parts, except wire.... .85
Thordarson Amplifying Transformer 2.75

Scientific Dealers Supply Co.
2727 Fullerton Ave., Chicago, Ill.

M-R FLEXIBLE VARNISHED TUBING
THE GENUINE
"SPAGHETTI"
TWO STYLES—BEST GRADES MADE—ALL SIZES—ALL COLORS
Varnishes, Waxes, Compounds, Papers, etc.
MITCHELL-RAND MFG. CO.
14 VESEY STREET NEW YORK, N. Y.

Mr. Dealer: Tie up to High-Grade
FROST RADIO Merchandise
A well-known National Reputation for Satisfactory Service guarantees you a Quick Turnover.

FROST-RADIO LEADERS

Frost-Fones
A Quality Achievement. Ideal Receivers for use with Home Radio Sets. Combine maximum efficiency with permanent sensitiveness.

Frost-Radio Extension Cord and Plug
Comes in lengths from 10 to 100 ft. Loud speaker can be placed anywhere and connected with Radio set with Frost-Radio Extension Cord.

Receiving Transformers
Will tune in all stations up to 3,500 meters. Hand rubbed mahogany finish. Wound with green silk covered wire. Immediate deliveries.

Frost-Radio Improved Plugs and Jacks
Specially designed for Radio Panel Work. Plugs are interchangeable with other standard makes.

Cunningham Vacuum Tubes
Nationally recognized as the Ideal Detector or Amplifier Tubes for use with Radio Receiving Sets.

Remler Radio Apparatus
Radiates Quality. Every Remler item is first studied and tested for its practical Radio utility before being marketed.

Frost-Radio Protector
Listed by Underwriters' Laboratories under April, 1922, regulations. No interference with clear Radio receiving. Never Grounds. Mounts indoors. Price \$1.50. Good deliveries on this approved device.
The best jobbers in your locality can supply you. See them now

HERBERT H. FROST
NATIONAL FACTORY DISTRIBUTORS TO THE ELECTRICAL-RADIO JOBBER
154 W. LAKE ST. CHICAGO, ILL.

3000 OHM SETS, \$4.50
2000 OHM SETS, \$4.00 1000 OHM SETS, \$3.50
Plus 20c for Postage and Insurance
Satisfaction Guaranteed or Money Back



TOWER'S SUPER-SENSITIVE RADIO-PHONES

We mail phones the day your order arrives. Every pair tested, matched, and guaranteed as sensitive as \$8 to \$10 phones. We have no agents or dealers. By ordering direct you save dealer's profits—circular free.

TOWER MFG. CO., Brookline, Mass.
18 Station St.

Announcing the New

RADIO HOMCHARGER DE LUXE



Combines Beauty with Utility

The HOMCHARGER charges your customers' "A" or "B" Battery over night for a few pennies. Silent and clean in operation. May be used everywhere.

Simplicity itself—attach to any lamp socket and connect the battery. Self-polarizing and fully automatic in operation.

Absolutely SAFE. No danger from shock or fire. All parts entirely enclosed. Approved by Insurance Underwriters everywhere.

Beautifully finished in mahogany and gold. Harmonizes with the finest furnishings. Equipped with rubber feet, it will not mar the finest table.

Substantially constructed of the best materials throughout. Moulded Bakelite Base—Jewell Ammeter—Over-size Silicon Steel Transformer. No rough castings to break—only the highest quality steel and brass stampings used. Lasts a lifetime—UNCONDITIONALLY GUARANTEED.

Furnished complete with attachment cord, plug, charging cable and battery clips at the popular price of **\$18.50**

*HOMCHARGER Merchandising Possibilities
are further explained on next page.*

Broadcasting the Convenience
of
HOMCHARGING
to
15,000,000 Prospects



OVER 40,000 HOMCHARGERS were sold thru jobbers and dealers last spring. Over 150,000 will be sold this fall and winter. Will you get your share of PROFIT from this fast-moving, easily-sold and nationally advertised Radio and Automobile Accessory?

An absolute necessity—little competition—no after-service—means money in your pocket.

Decide NOW to get your share of this business. Display the handsome HOMCHARGER window trims, counter cards, etc. Distribute our attractive circulars to your trade—use our electros in your catalog, mailing matter and newspaper ads. "HOMCHARGER BUSINESS BUILDERS," illustrating these attractive Sales Helps, is FREE for the asking. Send for your copy TODAY.

Order your fall stock of HOMCHARGERS NOW thru your jobber or communicate with our nearest Branch Office. Be the first dealer in your locality to display the NEW RADIO HOMCHARGER DE LUXE.

The AUTOMATIC ELECTRICAL DEVICES Co.

144 WEST THIRD ST.

CINCINNATI, O., U. S. A.

Largest Manufacturers
of
Vibrating Rectifiers
in the
World

Type "A" Homcharger
for Wall Mounting
Over 40,000 in Use

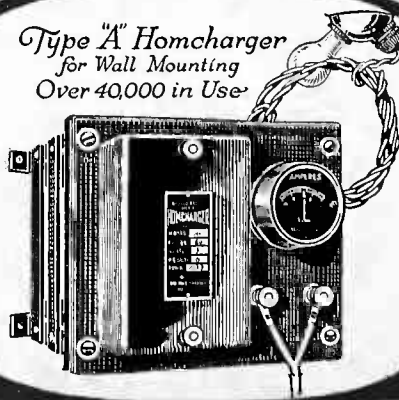

BRANCH OFFICES
New York - Chicago - Pittsburgh
Detroit - Dallas - Philadelphia
Los Angeles - Baltimore
Minneapolis - Kansas City
St. Louis

Rescue Radio

Broadcasters Sometimes Are Very Serious Nuisances

James M. Seymour, writing to the Newark Evening News, complains about the present status of broadcasting, telling how the broadcasting stations interfere to the discomfort of radio apparatus owners.

"It is about time the newspapers of the country joined hands with the public and rescued this art from the mercenary advertisers, who, if allowed much more rope, will hang radio in its infancy," says the writer.

Improper use of the mails is prohibited, and improper use of the air for radio advertising must be prohibited if the people of this country are to reap the full benefit of the art.

A while ago the Mayor of Boston formally opened a broadcasting station operated by a Boston department store. He complimented the owners on the great public service they were rendering. That very night the new station "tested" all the evening, and the service to the public consisted of a big noise by the jazz band which is part of its restaurant equipment, and the announcer spent most of his time describing the stock in trade, from rubber-soled shoes to pink shirts with ties and hat bands to match.

The greatest good to the greatest number can only be achieved by complete government control and operation of all broadcasting stations.

Fifty government broadcasting stations properly zoned and regulated as to wave length would serve all the people in the United States with good music, good addresses and daily or hourly information on all subjects of general interest. No politics; no advertising; no special interests to be served; the education and amusement of the American people to be the sole object of such a government department. It must come to this sooner or later. Why not try to save radio now before it is set back a decade by a few to the detriment of all the people?

OUT OF THE MAZE OF REGENERATION

On a recent circular of the New Haven Radio Company is shown a complete hook-up of Armstrong's Super-regenerative Receiver that is uniquely simple. To those who have gazed with awe at the recent illustrations and drawings of this circuit, this circular will be a salve for their wrath. Actual photographs of the assembled units are arranged on the page and pen lines represent the wire connecting these units.

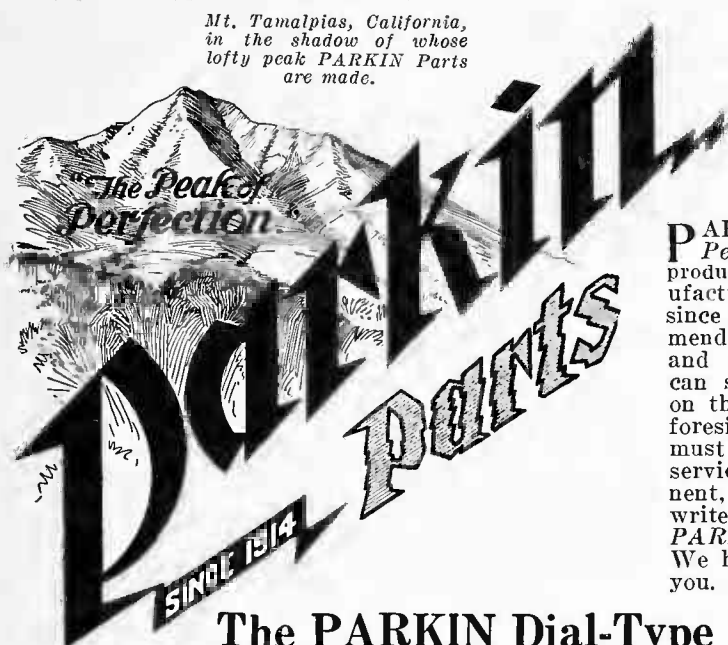

Since
1914

PARKIN Parts are "The Peak of Perfection," the product of experienced manufacturing—P A R K I N since 1914. You can recommend them both profitably and conscientiously. You can stake your reputation on them. If you have the foresight to realize that you must sell quality and give service to build a permanent, profitable business, write for the complete PARKIN catalog (No. 8). We have a proposition for you.

The PARKIN Dial-Type RHEOSTAT

"The Peak of Perfection" (Patented)



Resistance element is mounted in a recessed groove in the back of a 3-inch moulded Bakelite dial, which saves the cost of an extra part, gives more cabinet space, and eliminates resistance heating from inside the cabinet. An off position is provided and a stop on the dial engages the stationary contact at the extreme positions. 360° rotation insures fine adjustment, and a brass bearing insures true running. Figures and graduations filled with brilliant white enamel. Brass parts nickel plated. Dial and knob both of die-moulded Bakelite. Resistance 5 ohms, carrying capacity 2 amperes. Only 2 panel holes required for mounting. Instructions with each instrument. Order No. 77—retail price, \$1.75.

Write for complete PARKIN catalog (No. 8)

Parkin Manufacturing Co.

SAN RAFAEL

CALIFORNIA

Revised Radio Dealer List

Do not attempt to do without the best radio dealer list—you cannot save your money that way.

Buy our list, recently revised from local sources. It will make money for you and get you there first. Write for prices and details.

Revised Radio Jobber List

This is a fully inclusive one, with many recent names. You cannot fail to find it valuable. Write for prices and details.

Unique New Mounted Broadcasting Map

Ready to hang on wall, large size, colored pins marking government, newspaper and private stations; circles, marking crystal and tube set range, \$37.50. Also special large sizes.

Radio Merchandising Research

This is 100 typewritten page analysis of situation; illustrated with charts; up-to-date, expert sales and distribution analysis. Price \$150.00. New or old radio firms should not fail to buy it.

The Business Bourse

International, Inc.

For 14 Years the National Clearing House of Business Data

15 W. 37th St., New York City

Telephone, Fitzroy 6720

Scott Detector

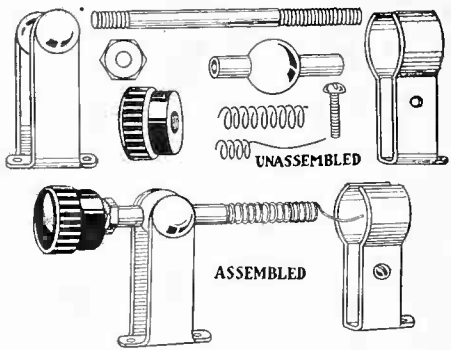

Complete parts as illustrated. Brass. Nickel Plated Ready for mounting. **List 40c**

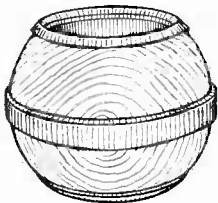

Manufacturers, Jobbers and Dealers

Write

SCOTT NOVELTY CO.

33 Springfield Ave.

Newark, N. J.

NOTE TO THE TRADE:

Quote us prices, terms, discounts and deliveries

WE ARE
NATIONAL
DISTRIBUTORS

Complete sets
Radio Equipment
SPECIALTIES

Manufacturers

Desirous of New York
Representation communicate at once

**RADIO EQUIPMENT
SERVICE**

500 FIFTH AVENUE
NEW YORK CITY

The "Wave" Antenna

Has Materially Reduced Static Interference

J. BERNARD
Publicity Department
Radio Corporation of America

The thousands of amateur radio fans, a majority of whom are realizing for the first time what an interference static is to the reception of the various programs broadcasted, will be interested in knowing what means the large commercial companies, such as the Radio Corporation of America, are taking to offset this atmospheric disturbance.

Perhaps the chief means used by the Radio Corporation is in the type of aerial. This is known as the "Wave" antenna, which in addition to reducing static interference, has greatly increased the efficiency of trans-Atlantic wireless telegraphy.

An explanation of this antenna is best gained by a description of its use at the chief receiving station of the Radio Corporation, located at Riverhead, L. I. This station receives from all European stations which are using wave lengths ranging around 15,000 meters in length, or in other words, electro-magnetic waves each approximately nine miles long.

In order to fulfill all of the requirements of the theory covering the operation of the new antenna, it is necessary to have a receiving aerial one full wave length long, or, in other words, a receiving aerial wire miles in length. This is exactly what has been installed at Riverhead. The aerial is nine miles long, and is supported on poles thirty feet above the ground, one end being grounded through a non-inductive resistance, and the other through a variable inductance. With this wire the Riverhead station is daily receiving five different European stations simultaneously without interference.

To illustrate the operation of the "Wave" antenna, an engineer of the Radio Corporation of America has drawn the following analogy:

"If we look upon the new antenna as a large lake and the wind as the static, we can get an idea how it works. Now, suppose the wind is blowing across the lake from east to west. At the eastern end there will be few or no ripples, but as we get to the western end the ripples will gradually increase in size to full waves. If the shore at the western end is a gentle slope of sandy gravel, the waves will be dissipated and will not be reflected.

"If, on the other hand, the shore of the lake is precipitous and rocky, the waves will be reflected and will dis-

PATENTS

PROTECT YOUR INVENTION TODAY

Write for 1922 illustrated book free. Radio-Electrical, chemical and mechanical experts; over 20 years' experience.

A. M. WILSON, INC.,
309-20 Victor Building, Washington, D. C.
(Successors to business established 1891 by A. M. Wilson)



Radio Reception Explained

HOW TO BUILD

- Double Slider Type Crystal Receiving Set
- Loose Coupler Type Crystal Receiving Set
- Single Circuit Vacuum Tube Receiving Set
- Vacuum Tube Receiver and Two Stage Amplifier
- Loose Coupler Tuner and Vacuum Tube Detector
- Short Wave Long Distance Variometer Regenerative Tuner
- Radio Frequency Amplifier and Variometer Regenerative Tuner
- Combined Radio-Audio Frequency Amplifier Circuit

Great Lakes Publishing Company
Detroit, Michigan

BUILD BUSINESS

Sell more parts by creating interest in radio matters. Distribute an inexpensive book which not only explains radio reception but also tells how to build eight separate types of receiving outfits out of parts you are selling. Complete bills of material given for each type listed and described. This will be of great help to your customers and profitable also.

List, 50c Sample, 20c Very liberal discounts

Desk 4—Great Lakes Publishing Co., Park Place, Detroit, Mich.

Our new catalog is ready :- :- :-

Most complete Radio Catalog published :- :- :-

Over 100 illustrations

Wholesale and Retail
DETROIT ELECTRIC CO.
113 E. Jefferson Ave. Detroit, Mich.
Est. 1883

Ask Our Service Bureau

Jobbers and Dealers



The Radio Book of Books

This Book helps sell your Supplies and Parts

Dealers Make 66 2/3% on Investment

One price, any size order. Attractive jobbers proposition. 12 of the best simple diagrams, including Armstrong Regenerative Hook-ups, National advertising, backing it up display material with order.

ARCHWAY BOOKSTORE
224 Pike St. Seattle, Wash.

turb the eastern end of the lake. Now this antenna, having a non-inductive resistance at its non-receiving end, corresponds to a sandy shore, because it absorbs the static and interfering waves and does not reflect them.

"Carrying the analogy further, if we place a stationary paddle wheel at the western end of the lake, which is revolving uniformly and producing waves of a uniform character, these waves will travel steadily forward toward the eastern end and will not be interrupted by or stopped by the wind. This paddle wheel corresponds with the transmitting station and the waves it sends out are equivalent to the waves from the European station.

"The tests which have been conducted at Riverhead completely confirm this theory. When the receiving apparatus is placed at the end which is grounded through the non-inductive resistance it is impossible to hear anything but a terrific roar due to continuous static discharge. Using the wire properly as 'wave' antenna, trans-Atlantic wireless communication can be carried on without any difficulty, despite the static.

This antenna system can not be carried out by the amateurs because of lack of space, but the system suggests many promising methods upon which radio engineers are busy and who hope to solve this problem of remedying, if not eliminating static in the radiophone broadcast entertainment.

REAL DEALER HELP

The Howell Cine Equipment Co., Inc., of New York City, furnishes its dealers with a very attractive and interesting catalog and circular in folder form. One side of the folder tells of the simplicity of the radio sets advertised—what can be heard and, in simple language, the theory of radio reception together with a description of the more important parts. The last page of the circular gives a list of the large broadcasting stations in the United States and a typical program of WJZ. The reverse side of the folder shows cuts and gives descriptions of various attachments and parts, and finishes with an interest appeal for the farmer. There seems to be a dearth of circulars for the average dealer's counter. The public is by no means fully educated to Radio. More circulars of the Howell Cine type are urgently needed.

ANOTHER EXPANSION

The Westwyre Radio Company of Westfield, Mass., formerly the Westfield Machine Company of that city, have announced that, believing in the future of radio, they have greatly expanded their facilities.

SPECIALTY SERVICE COMPANY
 Manufacturers of
RITE RADIO PRODUCTS
 Distributors for
LAWSAM RADIO PRODUCTS
 and Other Standard Equipment
Write for Prices and Discounts
 Cor. 4th Ave. and Pacific St. Brooklyn, N. Y.

DEALERS **PRICE \$1.50**
JOBBERS *IMMEDIATE SHIPMENTS*
DISTRIBUTORS
MANUFACTURERS

THE
 TRADE
"Q-R" VERNIER ADJUSTER
 MARK

Write for our new discounts and special proposition.



Pat. Pend'g.

That new receiving set will not be up to date until equipped with a Vernier Adjuster.

"ELIMINATES CAPACITY EFFECT FROM THE HANDS AND WE ARE GETTING SIGNALS WE NEVER HEARD BEFORE"

ROBINSON SPECIALTY COMPANY
 21 WALNUT ST. **"Q-R" PRODUCTS** KEYPORT, N. J.

NATIONAL DIRECTORY OF RADIO DEALERS, MANUFACTURERS, ETC. SUPPLEMENTARY SERVICE OF ADDITIONS, REVISIONS, ETC.

Sydell's Radio Directory and Service
 557 SCHENCK AVENUE BROOKLYN, NEW YORK

Card Catalog Directory of Radio Dealers
 Sent upon APPROVAL
 (Also available on SHEETS)

No comparison between this directory and similar commercial "mailing lists"
 No mailing list companies offer to send theirs upon approval

WHY?

Names in our directory are annotated to indicate wherever possible the distinction between exclusive dealers in RADIO equipment; those who handle RADIO only as a side line, as dealers in electrical supplies, hardware stores, jobbers, manufacturers' distributors, etc.
 This list has been compiled from information secured from State Chambers of Commerce, current RADIO periodicals and newspapers having RADIO departments, and contributions from Manufacturers, Dealers, Jobbers, etc.
 Dealers desiring inclusion please send particulars without obligation.

In Preparation
 A similar directory of RADIO MANUFACTURERS
Please send descriptive literature

Condensers—Guaranteed—Tested—Perfect
Order now for immediate or fall delivery

43 plate001	\$2.00
21 "0005	1.35
11 "00025	1.10
3 "	Vernier	.80
.005 variable for Armstrong circuits..... 6.00		
Fixed Phone Grid—Grid Leak..... .07		
Special Offer to Jobbers		
DUKE RADIO CO.		
1758 Bergen Street	Brooklyn, N. Y.	

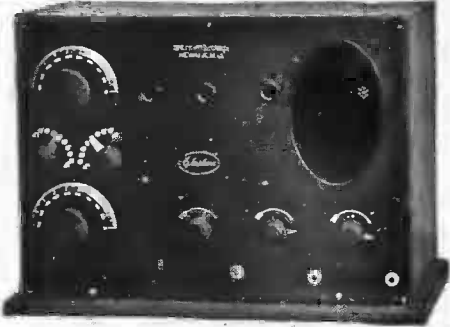

Echophone Loud Speaker Sets

IMMEDIATE DELIVERY

Discounts to jobbers and dealers
AERIAL WIRE.

19 strand tinned silicon bronze
VARIABLE CONDENSERS

11-21-23-43 Plate

EISEMANN HEAD PHONES

Super-sensitive

Variometers **Variocouplers**
Binding Posts **Contact Points**

General Auto Electric Co.

231 Halsey St.

Newark New Jersey

Dealers!

Why scatter your purchases among many different concerns? We can supply everything essential to successful radio operation—each and every article standardized and backed by the manufacturers' absolute guarantee. Your detail work will be simplified and money saved by purchasing all your equipment from us.

Among this month's specials:

12,000 Ohm Resistances

.1 Henry Choke Coils

for Armstrong's Super-Regenerative Receiving Sets, accurately tested in our own laboratory.

Write for our price list

**RADIO & MECHANICAL
TRADING CORP.**

23 Warren Street Barclay 0926
NEW YORK CITY

Retailers' Ideas

(Continued from page 46)

next president, governor, mayor or councilman and the number of votes the candidate will get. Many persons will hazard a guess in such a contest and the advertising benefits derived from such contests are well worth the cost of the prize.

"Guess how many peas in the jar," or "guess how long the candle will burn" are the captions one sees in a store window about which is either to be found a jar of peas or a huge fifteen-inch candle burning.

These are familiar contests—one might say they are "standard contests" for retailers.

Are they trade pulling? That's the most important thing, of course. They are interest-compelling, it is proven, but should be considered in the class of genuine advertising.

Radio stores may not require contests right now to acquire public interest, and yet why not do something to hold the attention of the prospective patron?

Why not put a "loud sounder" on the store set? Why not? There is no reason at all, but be sure to keep it going all the day.

If every retailer in, say, Newark had a loud speaking set in his store for one week everyone in that busy place would know about radio first handed and the great advantage to trade must be apparent.

Acquire a Reputation

**Selling Job Lots Does not Make
for Continued Success**

Too much time should not be spent by the retailer in searching for bargains, as the displaying of such stock has a potent influence toward driving off the buyer looking for real quality. When goods are sold by job-lots at an extremely low price there is usually something the matter, otherwise they would not have to be sacrificed.

The goods may be inferior or they may be in poor condition or have some other fault. It is a reasonable surety that the dealer cannot list them in his regular stock without injuring his business.

First-class buyers are ever seeking the goods of real quality and in the long run the high-grade dealer will find such trade the most profitable. Cheap customers are ever looking for

"COPPERWELD"

TRADE MARK REG. U.S. PAT. OFF.

ANTENNA WIRE

50% stronger than either
solid or stranded copper

ELIMINATES SAGGING

Adopted by Largest Radio Corporations
100, 150, 200 ft. per Carton

LEAD-IN and GROUND WIRE

has the Underwriters' O. K.
Rubber Insulated—Brown Braid

25, 50, 100 ft. per Carton

BUY IT IN CARTONS

with construction directions

COPPER CLAD STEEL COMPANY

New York Chicago
Braddock P. O., Rankin, Pa.

Immediate Shipment

on

IRVINGTON

Flexible Varnished Tubing
"Spaghetti"

5000 Volts—Puncture Test

also on

AERWIN

PRODUCTS

Variocouplers

Variometers

Special Detector Crystal

Model A Receiving Unit

Collapsible Loop Antenna

"Kentone" Radio Amplifying Horn

WRITE

The Mills Radio & Electric Co.
Incorporated

1010 Springfield Avenue
Irvington, N. J.

RADIO BOXES

AND

CABINETS

Send us your specification and let us figure on your requirements.

PROMPT DELIVERIES.

THE WEIS MFG. CO.

Monroe, Mich.

cheap junk and the profit from such dealing is meager.

A dealer is bound to lose his best customers if he features such stock, and his establishment will degenerate into a "Cheap John" store. In stocking a store it is a practical advantage for an experienced retailer to exploit an article of quality.

At times it is good to acquire articles on which his own name may be used in the branding. Having parts made to order a retailer can have an article made as he sees fit, entirely after his own ideas and bearing that his own private trade mark. That is a good way of building up trade on one's own reputation.

If the article contains unusual merit it becomes a valuable advertiser and may even reach the prestige of being what is termed "a household word," and the incidental benefits can hardly be overestimated. People who are acquainted with such an article or who have heard it recommended, visit the store where it is exclusively sold and incidentally make other purchases and become regular patrons.

SHELVING HEIGHTS

A convenient height for shelves in a modern store is up to seven feet. While it is true that the space above that dimension can be utilized, it is always best to place those goods subject to rapid demand within the height of seven feet. Above the seven feet can be shelved those goods that are either not "seasonable" or not subject to regular call.

Of course, a retailer must not lose sight of the fact that some one must dust those goods at the top occasionally for appearance sake. If he does not adhere to that practice he will eventually learn that he has a lot of shop-worn goods on his hands.

If a dealer has a better place for the "seasonable" goods, or those not subject to a ready call, the upper space above the seven-foot limit may be devoted to dummy boxes and other advertising paraphernalia, such as package designs and other contrivances of the window displayer's art.

It is not well to place "live" stock on the higher shelves, as such merchandise so placed is likely to be dropped by an impatient clerk when he reaches for it. The average clerk will not climb up to those upper regions unless he is forced to. It is too far out of his way.

Ask Our
Service Bureau



EMELOID DIALS—2"—3"—4"
 2" 35c—3" 50c—4" 60c
 MANUFACTURERS—JOBBER—DEALERS
 WRITE FOR DISCOUNTS
 EMELOID CO., INC., 536 JUNIUS ST., BROOKLYN, N. Y.

RADIO DEALERS
We Are Manufacturers of

**AUDIO AMPLIFYING
 TRANSFORMERS,
 SENSITIVE CRYSTALS,
 EYELET TYPE MICA
 CONDENSERS,
 LOOSE COUPLERS,
 DOUBLE SLIDE
 TUNING COILS**



*Dealers and Jobbers
 Write Us for Proposition*
IMMEDIATE DELIVERY

FORD MICA CO., Inc.
 15 CHRISTOPHER ST. NEW YORK CITY

NOVO "B" Batteries



for Radio Outfits
NOISELESS—DEPENDABLE—GUARANTEED
 All Sizes—Plain and Variable
 22½, 45 and 105 Volts
Send for Catalogue and Discounts

NOVO MANUFACTURING CO.
 424 W. 33rd St. NEW YORK 531 So. Dearborn St. CHICAGO

"UNITED" Radio Products

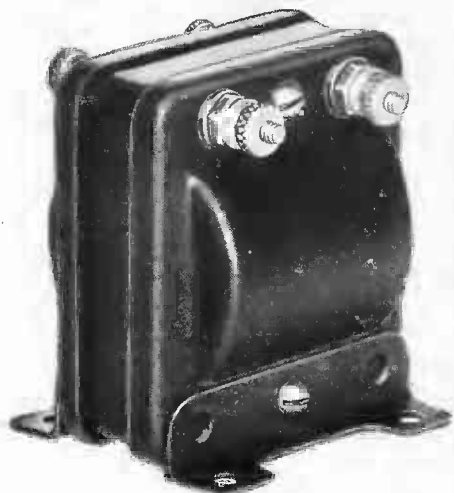

Two Finishes—Black Enamel or Buffed Nickel Plated \$4.50

"UNITED" Audio Frequency Transformers

Radio dealers will find in the "United" Transformer the same high grade workmanship and engineering skill which have made the "United" Condensers the standard in the variable condenser field.

"UNITED" Variable Condensers

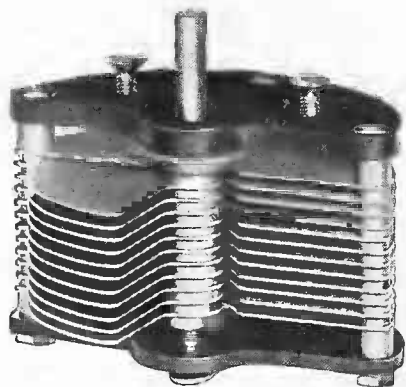

In every field there is a standard by which everything else is compared. The fact that "United" Variable Condensers have been accepted as the standard is sufficient in itself to warrant your not buying any other until you have made a comparison.

Prices	
43 plate	\$4.50
23 "	4.00
11 "	3.50
5 "	2.75
3 "	2.25

Without dial or knob.
Write for Discounts

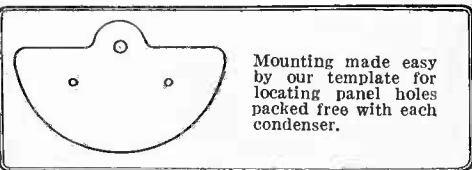

Mounting made easy by our template for locating panel holes packed free with each condenser.

NOTE

Any advertised claim of having an arrangement with us to sell our product at special prices, is fraudulent.

United Mfg. & Distributing Co.
536 Lake Shore Drive Chicago, Ill.

Why is a Distributor?

(Continued from page 30)

legitimate and illegitimate jobbers may be drawn.

In my own organization, salesmen go forth eager to sell but are under strict orders to quote no one jobber's prices unless satisfactory evidence is given of their being jobbers in trade as well as in name. If one of my salesmen encounters a dealer who insists he is a jobber, ask for proof not in the form of letter heads, advertisements or local orders, but in the form of actual orders from concerns outside their immediate vicinity, showing discounts quoted to be discounts customarily given by legitimate jobbers to legitimate dealers. Once this condition is stabilized, the present era of slaughtered prices will be over and the industry will grow into the tremendous field it is destined to be.

Note: The writer would be pleased to receive communications from anyone interested in organizing a bona fide jobbers and dealers association and will cooperate to every extent in the organization of such an association.

RADIO HELPS THE DEAF

Wireless, with all the manifold benefits already to its credit may enable the deaf to hear, thinks a writer in the London Medical Press. If recent experiments with wireless telephony come up to expectation, he says, then there is little need for the deaf to give up hope, for by means of "thermionic" valves persons exceedingly deaf have been enabled to hear.

He records the case of a man of 50 who had been deaf for many years, so deaf that he could only hear the shouted voice. Nevertheless, he experimented with wireless telephony. It occurred to him that by increasing the number of thermionic valves in his receiver he might thereby raise the sound to a degree of intensity to be heard easily. This he did, working up gradually until he had five thermionic valves in his apparatus, with the result that he can now hear his friends in Paris more plainly than he can a person sitting in the room beside him. Also his hearing for the ordinary voice has become more acute.

The Marconi Company's experts are using a valve similar to the thermionic on their "bonaphone," an instrument for imparting sounds to the brain by means of the bony parts of the cranium. It has enabled a large number of persons to hear who hitherto were deaf.



PRESCO Radio

Licensed under
Armstrong U. S. Patent No. 1113149

In the last four weeks five of the largest jobbers in the United States have, after competitive tests, purchased Presco receiving sets.

A dependable set—reliable—easy to operate—you can sell it with every confidence, and at present be assured of at-once shipment.

Write for discounts



Ask Our Service Bureau



French RAY-O-LITES and Dry Batteries

8 Reasons Why You Should Sell RAY-O-VAC "B" Batteries

22½, 45 and 100 Volt Sizes

1. Individual cells are noiseless throughout their entire life.
2. Cells are bound by special material that holds them rigid.
3. All connections are perfect and permanent.
4. Each cell is thoroughly insulated, by an exclusive process.
5. Batteries are compact and waterproof.
6. Equipped with special spring-clip terminals that will not cut wires.
7. They give your customers complete satisfactory service and bring repeat orders.
8. Made by the same experts who have made French Ray-O-Lites famous for quality.

Write for Bulletin 225 and Prices

FRENCH BATTERY & CARBON CO.

MADISON, WISCONSIN

CHICAGO MINNEAPOLIS NEW YORK
ATLANTA DALLAS DENVER
KANSAS CITY





L. P. Horning, Jr.

One of the pioneers of the radio industry and well-known young inventors is Louis P. Horning, Jr., of Elizabeth, N. J. In the past three years Mr. Horning has invented over three hundred radio and electrical devices which are used in all parts of the world to-day. Besides being an inventor-manufacturer Mr. Horning is a real "dyed in the wool" old timer when it comes to radio amateurs. He is one of the charter members of the Plainfield Radio Association, Inc., one of the best radio clubs in the State of New Jersey. Being a member of such organizations keeps him in touch with the amateurs, he says, and keeps his equipment in front. This is evident in the many news items that have and are appearing in many newspapers. On November 10th, 1921, at the first radio dance of this association Mr. Horning's apparatus was used. Over two hundred attended the dance. Mr. Horning has for the past two years conducted a "radio page" for one of the local newspapers in his home town. Some of Mr. Horning's inventions are: the Radio-Fone-O-Graf, a combined radio telephone and phonograph, Two-step loud speaking amplifier, loud speakers, phonograph microfones, Super-system fire and burglar alarms, Fonealarm, Detector-Fones, Solid microfones, and numerous other minor inventions pertaining to the phonograph.

Mr. Horning guarantees every instrument he sells, and the word of an "old timer" is something to bank on. The business was established in 1911.

Milliken Radio Towers

Are used for the principal broadcasting Eastern Stations. Suitable for all classes of service. Made of galvanized steel, self-supporting and in standard types. Heights up to 300 feet. Attractive proposition for dealers.

Send for Catalog No. 16

MILLIKEN BROTHERS MFG. CO., Inc.
Woolworth Building
New York, N. Y.

STATION WVP

STATION WBZ

STATION 2XJ

LATEST and MOST POPULAR

Radio Books

Radio Hook-Ups , by M. B. Sleeper	\$.75
An indispensable book to the radio amateur who designs or builds his own receiving apparatus.	
Radio Design Data , by M. B. Sleeper75
A book giving tables and data for designing receiving and transmitting apparatus.	
Construction of New Type Trans-Atlantic Receiving Set , by M. B. Sleeper ..	.75
Tells how to listen to the high-power telegraph stations of foreign countries.	
Construction of Radiophone and Telegraph Receivers for Beginners , by M. B. Sleeper75
Tells in detail the building of radio apparatus.	
How to Make Commercial Type Radio Apparatus , by M. B. Sleeper ..	.75
Describes in detail many commercial types of transmitting spark and vacuum tube sets, both telephone and telegraph and receiving equipment of all kinds.	
Wireless Telegraphy and Telephony Simply Explained , by A. P. Morgan	1.50
A book the Radio experimenter cannot afford to be without.	
Experimental Wireless Stations , by P. E. Edelman	3.00
A book describing all modern improvements.	
A B C of Vacuum Tubes Used in Radio Reception , by E. H. Lewis. . .	1.00
A book explaining in detail all about vacuum tubes.	

FREE! Catalogue of Wireless, Automobile and Other Books Sent Free on Request

The Norman W. Henley Publishing Co.
2 West 45th Street, New York

Liberal Discount to Supply Houses. Write for full particulars and dealer's proposition.

What the Manufacturers Are Doing

New Knob and Dial Built by Tait Company

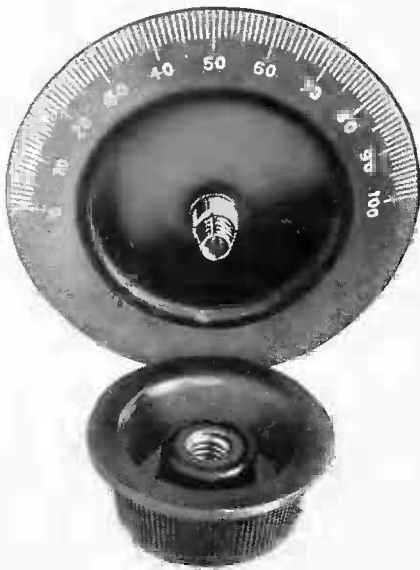

Robert W. Tait, of New York City, has recently been granted a patent on a knob and dial for radio uses, eliminating the use of the set-screw, which according to the manufacturers, should revolutionize this particular branch of the industry.

The knobs and dials used in the

past in regulating radio devices, such as variometers, condensers, etc., have frequently utilized the troublesome set-screw as a means of securing the knob and dial to the shaft.

The manufacturer claims that all disagreeable and costly features have been eliminated through Mr. Tait's new invention.

To mount this knob and dial it is simply necessary to hold the dial with one hand, and screw on the knob with the other. No tools are necessary. When fastened it will not wobble on the shaft, at the same time being self-centering and self-aligning. A change for the better is also noticeable in that the numerals are at the correct angle for best visibility.

These beautifully patterned knobs and dials are made of the best grade of Bakelite, being given a smooth and lustrous finish, while the knob employs a finely knurled tapering grip.

The Tait Knob and Dial Company, of 11 East 42nd St., New York City, are the manufacturers.

MICAPHONE DEALER HELP

The Radio Mica Products Company of New York City, manufacturers of a mica diaphragm for phones marketed under the trade name of Micaphone, furnishes its dealers with some novel sales helps. The Micaphones are packed a pair to the box, each box bearing a striking orange label on which is printed the trade-mark and trade name "bell-tone mica." There are twelve of these boxes packed in a gray carton also having the orange label. A novel help also furnished the dealer is a very much enlarged perfect model of the Micaphone in beautiful amber, with armature, spacing and each detail perfect, the whole suspended from a white porcelain standard, the base of the standard displaying the original Micaphone package complete even to the orange label. This has



The Silent Salesman

proven itself a real seller. According to a report, in a two-hour test at the Winchester's 42nd Street store in New York every observed customer entering the radio section asked for Micaphones. Other selling helps are furnished, including circulars, illustrated and explanatory matter, advertising cuts and the usual co-operation is assured to dealers.

Federal A-F-Transformer

Radio experimenters are unanimous in their praise of the well known Federal No. 226-W. Amplifying Transformer manufactured by the Federal

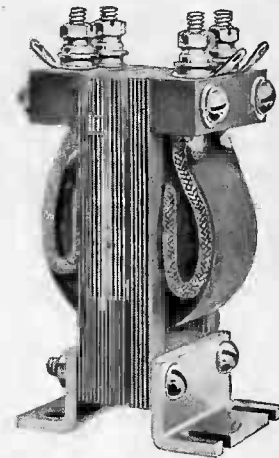

Telephone and Telegraph Company, Buffalo, N. Y. This transformer provides the maximum efficiency in operation since the impedance at 500 cycles is the same as the internal impedance of the standard tubes now available. Because the flux leakage is kept at a minimum the tendency to oscillate at audio frequencies, due to stray field between circles in cascade amplification, is reduced to almost nothing. Few transformers have established such an enviable reputation for amplifying qualities and efficiency.

JEWETT MANUFACTURING VERY GOOD LINE

A B C Variable Condensers have nine distinguishing features of technical value and the makers are advertising these condensers and the features in magazines and newspapers.

The Jewett Mfg. Corporation, 342 Madison Avenue, New York, manufacture these A B C Condensers in their Newark factory, where A B C Units and Parts are produced.

The Jewett Mfg. Corporation is one of the most reliable and progressive concerns in the radio industry and produce carefully designed, properly produced and attractively finished radio parts.

DOWN'S MORSEOPHONE

The Wm. H. Downs Radio Co., of 86 Park Place, Newark, N. J., distributors of the MorseOphonE, announce they are prepared to make deliveries in any quantity.

The reception range of the Morse-ophonE covers all stations transmitting on wave lengths within the limits of from 50 to 500 meters, depending only on the power of the station's transmitting output, according to makers.

In every detail of design is evinced painstaking care, and not merely in the genuine Bakelite panel, mahogany finished and hand rubbed cabinet, or heavy and brilliant nickel plating, but in the least and in the most important of its parts, precision and high quality are pleasingly manifest.

Better Detectors

Crystal Detectors Are Much Abused and Praised

By C. G. CULIN

It is doubtful if any single piece of radio equipment has called forth more alternate praise and abuse than the detector crystal. Looked upon with scorn by the "bug" who has graduated to the tube stage—or two stage—it still remains the standby of the beginner and as such should be respected by the dealer who seeks to build up his trade. Every prospective customer cannot be persuaded to purchase the more expensive apparatus and much satisfaction can be obtained with a well selected crystal set. In fact one recognized authority on radio states that a crystal provides much better rectification than is obtainable with a vacuum tube.

Of course, the simplest rectifier is a piece of mineral of sufficient size to fill the detector cup but due to its formation this is not always practicable to obtain in a convenient shape and so was created the Wood's Metal mounting so commonly seen. This was effected by running the molten metal into molds of the required shape and size and inserting a piece of crystal in the mass which when cool held the mineral firmly embedded. An effort was made to keep the melting point of the metal down as low as possible to avoid possible injury to the crystal itself but in endeavors to cheapen cost of production the true Wood's Metal is not always used and the resulting temperature reaches a comparatively high point.

The mineral thus mounted presents but a single face for use though there may be more and better sensitive spots on the part embedded. Still the process was the best which had been thought out at the time and a patent was claimed on the same.

A new form of setting is now being shown. It is the invention of Curtis G. Culin, Jr., and consists of a small cup or metal cylinder of standard uni-

MANUFACTURERS

DEALERS

RADIO PANELS

of Genuine XX Grade Black

BAKELITE-DILECTO

Dealers —Let us write you about our "24 hour service" on popular size panels. This enables you to supply your customers with any quantity, without carrying a large stock.

Manufacturers —We are supplying a great number of manufacturers with panels, drilled, grained and engraved. Making weekly or monthly shipments according to their production schedule. Let us supply you. Send us blue print or sketch and we will submit prices and sample.

STANDARD RADIO PARTS CO.

30 Church St., Room 2013, (Phone—Cortlandt 2515) New York

"ASK OUR SERVICE BUREAU"

Dealers, Jobbers and Manufacturers who are not heeding this advice are missing a service that works with speed and efficiency, and in addition costs nothing.

If you want to buy anything in Radio

"Ask Our Service Bureau"

(Advertisement on Page EIGHTEEN, this issue)

GET YOUR SHARE OF THE BUSINESS

IN

EVERY FAN WANTS MICA DIAPHRAGMS

MICAPHONE

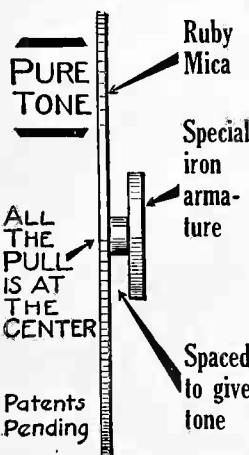

ADJUSTABLE A REAL SENSATION **MICA** MADE FOR EVERY MAKE OF PHONE

DIAPHRAGMS

SOFTENS STATIC—ELIMINATES NOISES—
GIVES WONDERFUL TONE—NATURAL
CLEAR SPEECH—SHARP SIGNALS
—NO DISTORTION

DEALERS WRITE FOR DISCOUNTS THEY ARE LIBERAL

STUDY THE CONSTRUCTION

EVERY HEAD-SET NEEDS THEM

IMMEDIATE SHIPMENTS

Radio Mica Products Co., 156 East 43rd, New York City



HALL-MARK OF QUALITY

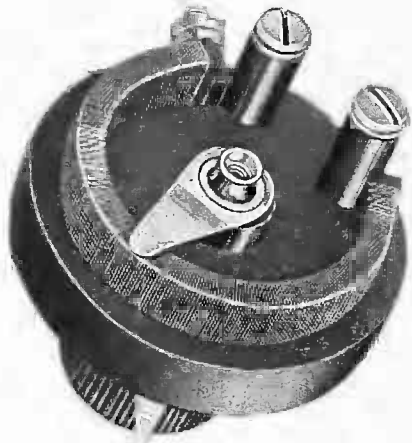

MODEL—A205

POTENTIOMETER

230 OHMS 0-2 AMPS

SPECIFICATIONS

Condensite Base

Ideal Resistance Unit

Phosphor Bronze Contact

Brass Posts

Highly Nickerled

SEND FOR OUR BOOKLET

"WHY WE USE CONDENSITE"

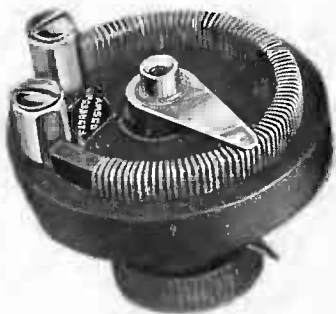

MODEL—A101

RHEOSTAT

ADVANCE METAL
STAMPING CO.

MANUFACTURERS

Department RE
19 THOMPSON ST., NEW YORK

form size and having an internal annular flange at its upper edge, a reduced central opening being formed by the flange through which the crystal is accessible.

The crystal is inserted into the cylinder from the larger end and is brought to rest upon the inner surface of the flange where it is held in place by a disc similar to the gun wad which holds the charge in a shot gun shell. It will be apparent that the life and usefulness of the crystal is greatly increased since it may be removed and replaced with another surface uppermost thus making available the greatest possible sensitive area instead of but a single fixed face as in the Wood's Metal method. Another advantage claimed is that being set without the use of any heat or embedding the crystal in metal, all the natural sensitivity of the mineral employed is insured.

The setting is distinctive in appearance, economical and simple in construction, it representing the combined advantages of the mounted and unmounted detector crystal.

COMPACT LITTLE SET

A very neat crystal detector is offered by the Mengel Company, 200 Fifth Avenue, New York, under the trade name of "Etherion."

Patents for this new set, which is contained in a handsome mahogany case, have been applied for. The very compactness of the set adds to its attractiveness while the simplicity of its appearance is said to make it a good seller. The whole set with its well finished case resembles nothing more than a box containing a safety razor.

The Etherion sells for \$5.00, while the wholesale price is \$3.75. All the mechanical requirements for good reception are present. The Mengel Company has branch offices in Louisville, Jersey City and Saint Louis.

ANDREA'S NEW QUARTERS

F. A. D. Andrea is backing up his opinion that the radio industry is in for an increase in business. The company has moved to new quarters at 1581 Jerome Ave., New York, N. Y. Mr. Andrea informs us that the "production facilities will be ten times greater" than heretofore. "Fada" is one more added to the list of those who are suiting the action to the word and proving to the doubting Thomases that Radio is going ahead and at no slow rate.

VACUUM TUBE DETECTOR \$5.50

Including complete cabinet with all instruments wired ready for use.



DETECTOR A N D
TWO STAGE AM-
PLIFIER \$22.50

With transformers and all other instruments in cabinet, ready for operation. This equipment is of high quality, and distances of as high as 3000 miles have been obtained with ease.

BATTERIES AND
TUBES EXTRA

2000 Ohm receivers \$5.00

SUPERIOR CRYSTAL RECEIVING SET \$4.75

Attractive dealers proposition

STEINMETZ WIRELESS MFG. CO.

5706 Penn Ave..

Pittsburgh, Pa.

For Finer Tuning use a

MORADIO

Every-Wire-Contact Coupler

LIST \$7.50

WRITE FOR PAMPHLET

Moreland Sales Corporation

30 Ogden St.,

Newark, N. J.

RADIO FREQUENCY SETS

RESISTANCE UNITS

1 OHM UP

(CALIBRATED)

"BROADCASTER"
MODEL VARIOMETER

LIGHTEST AND MOST
COMPACT ON THE MARKET

LIST \$6.00

"RIEHL"
TRANSFORMERS
AUDIO FREQUENCY
\$5.00 LIST

Screw Machine Work
Condenser Plates in Stock
Rheostats, Sockets

BISSELL ENGINEERING CO.

161-67 West 64th Street
NEW YORK

BOOK ON ARMSTRONG CIRCUIT

The Radio Electric Company of Pittsburgh has just placed upon the market a very interesting treatise on the new Armstrong circuit entitled "Instruction and Operating Data on the Armstrong Super-Regenerative Circuit." This booklet was written by Parker E. Wiggin, R. E., who served under Major Armstrong, the inventor, while in France and who later assisted him in designing the original circuit preliminary to the patent disclosures.

One of the distinctive features of this booklet is the easily read hookup of the circuit which appears inside the front cover. The explanatory data covers four pages and is very clearly presented, telling every detail of operation and construction embodied in this receiver.

Mr. Wiggin has accomplished a great deal in his experiments with this circuit and under his supervision the The Radio Electric Company is able to furnish any or all of the parts necessary in the three tube circuit of this booklet. Dealers who are seeking a relief from the summer slump should investigate this new departure thoroughly and if possible make demonstration sets to exhibit to the public.

MELCO UNIT SETS

The Melco, product of the Save Sales Company of New York, is a tuning and detector unit offered to the discriminating retailer.

The Melco is enclosed in a warp-proof cabinet of hand-rubbed, satin-finished mahogany. The face plate is of Radion and all the dials, adjusting knobs and binding posts are of similar design. All metal on the face plate is highly nicked and polished and the binding posts and dials marked for proper wiring connections and control.

Melco Type 400 can be operated in conjunction with a 150-meter antenna at wave lengths from 150 to 600 meters.

RASCO LINE COMPLETE

The latest catalog issued by the Radio Specialty Company, of New York, certainly proves the slogan, "Rasco Has It," for the forty-four page catalog is proof to the nth degree that this concern, managed by D. Salzman, is "up and doing" for the consumer as well as the retailer and jobber.

It is needless to enumerate the Rasco line for it embraces practically everything in radio apparatus.

WHY EXPERIMENT—MR. MANUFACTURER?

For years we have been cutting, drilling, machining, grain-ing and polishing Bakelite Dilecto.

Put this experience to work on your panels. Write us for proposition and sample.

STANDARD WIRELESS PANEL COMPANY
49 MECHANIC STREET NEWARK, N. J.

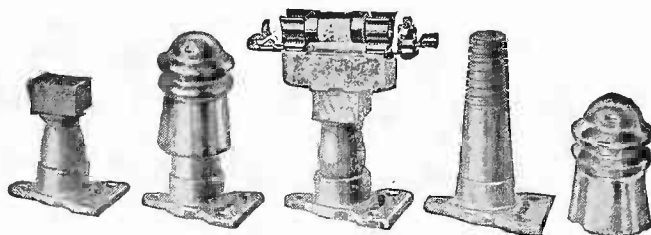

X-RAY INSULATOR ADAPTER

fills a long felt want for a lead in insulator—approved, up-to-date, complies with every regulation, both national and local, made in two styles—one for lead in, one for lightning arrester.

Aeroplane Wire

19 Strand Silicon Bronze Aerial Wire. Each strand (tinned.)
Guaranteed to give 100 per cent satisfaction.
This wire was used during the war by the U. S. Government for aeroplane and trench work and was the only wire to stand up under these conditions.

We have the entire supply and are prepared to make immediate shipments.
Cory Phones 2000 Ohms Connecticut Phones 3000 Ohms Turney Phones 3000 Ohms

Liberal Dealers' Proposition

HINTZE BROS., Inc., 459 Central Ave., Newark, N. J.

QUALITY-PLUS INSTRUMENTS



Type 711

HOME Radiophone Receiver

A vacuum tube set with wave length range of 150 to 2600 meters. Wonderful reception; simplicity of operation and extremely attractive appearance.

List Price, \$35

ADD-A-STEP DETECTORS AND AMPLIFIERS

Handiest instrument for station or laboratory ADD-A-STEP at any time. Extremely efficient, neat and compact.

PRICE: Detector, 704, \$5.75; Amplifier, 705, \$10.50.
These instruments awarded the Mail Radio Institute Certificates of Excellence, May 20, 1922.

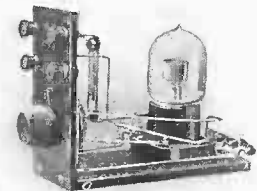

Type 704

DEALERS, JOBBERS, DISTRIBUTERS

Liberal discounts, quick turnover and hearty co-operation

Does this interest you? Wire or write immediately

ARROW RADIO CO.

Manufacturers of QUALITY-PLUS Instruments

HACKENSACK

NEW JERSEY

CA Concert Receiver of Radio Electric Co.

The Type CA Concert Receiver shown in the illustration has been placed on the market by The Radio Electric Company of Pittsburgh to meet the requirements of those desiring the utmost in appearance and efficiency.

The receiver consists of a single-circuit type tuner, a detector, three stages of tone frequency amplification and a specially designed loud speaking horn built into the set and equipped with a Baldwin or Western Electric phone. The unsightly feature of the external "B" battery has been eliminated by the provision of a special compartment large enough to contain the necessary batteries for successful operation. This latter feature also serves to reduce to a minimum the number of outside connections needed.

The controls are few in number and also quite simple. Those governing the filament current to the tubes, both amplifiers and detector, are shown in the upper portion of the panel. The two large dials placed on either side of the loud-speaking horn represent the tuning controls. The convenient size offers certainty and ease of manipulation and the engraved numerals are plain and easily read.

With the exception of the antenna, ground, and filament lighting battery, all connections are made inside of the cabinet. This insures a minimum of outside wiring and adds appreciably to the finished appearance of the receiver.

According to the manufacturers, when used with an antenna approximating 100 feet in length, and elevated to a height of from 25 to 50 feet, the Type CA Receiver will respond to amateur and general broadcasting signals over a wave length range of from 175 to 800 meters. In miles its range of reception of signals from high power broadcasting stations is very conservatively placed between 50 and 100 miles under all conditions.

RADIO NEWS SERVICE

Many rural papers—in the great, big middle West—are installing radio receiving sets, so that they are kept in touch with the world's affairs. These papers are, as a rule, not on the Associated Press news service nor are they served by the United Press. Radio is working wonders, indeed, for the rural editor.

AGAINST RADIO ADS

"In order to keep Radio broadcasting on the high plane it should maintain in the eyes of the public, it must be handled as a sport," says Francis F. Hamilton, Radio editor of the Indianapolis *News*. He is against the new advertising companies who plan to broadcast twenty-four hours in the day seven days in the week, permitting any retail store or mercantile firm to buy five or ten minutes' time each day to advertise their products whether they be soup, shoes, furniture or flivvers.

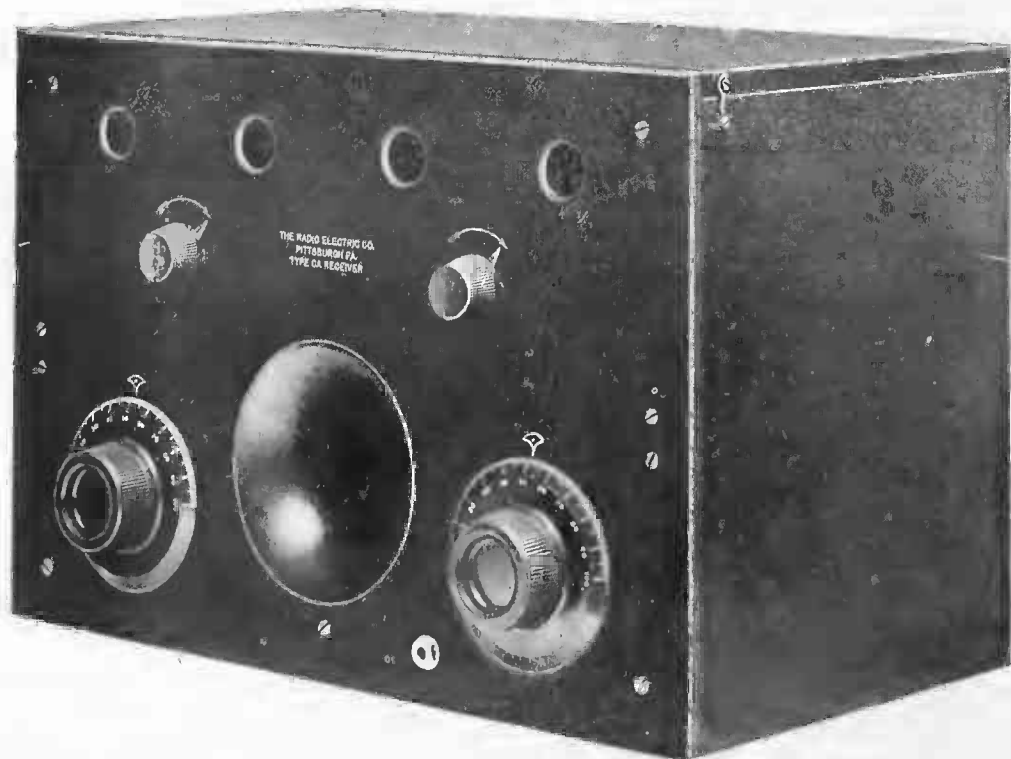

CA Concert Receiver of the Radio Electric Company



"A Marvelous Invention"

—say experts

AN age-old principle of sound amplifying is the secret of the wonderful tonal qualities of the Sheltone Loud Speaker.

The Sheltone is shaped like a shell. At its base is an open tone chamber over which any two standard receivers fit. This chamber carries the sound to the curved surface of the Sheltone, causing each note to marvelously swell in volume.

No tubing to rob the sound of its fullness; no horn, as on ordinary loud speakers, to destroy or distort the most delicate notes. Every sound is true, sweet, mellow and distinct to everyone in the room.

Even if you have a loud speaker, it will pay you to learn the delights of a Sheltone. Your friends are sure to admire it. The Sheltone is **different** from any loud speaker on the market. Substantially made, highly polished; only 8½ inches high.

\$5

WITHOUT RECEIVERS

THE SHELSTONE COMPANY
20 CLINTON ST., NEWARK, N. J.



Wonderful Radio

From Address at National Radio Exposition in Chicago

By EDWARD G. EGLOFF
Member, Radio Club of Illinois

It makes me feel good when I am on the streets, in public places or in private homes to hear radio on the tongues of every one from a boy just leaving the cradle to the old gentleman on his last stage of life, and compare the radio fans of to-day with the radio fans in the year 1906 in which year my radio experience began.

In those days radio was limited to the persons who understood the receiving of the Morse Telegraph code. As all radio transmission was done in code form, dots and dashes, radio had a small following of fans. I can recall in the year 1912 and 1913 when DeForest was experimenting with the radio phone on the great lakes. Night after night while I was listening to his radio phone, thoughts came to me that it would only be a matter of time when music as well as speech would be transmitted in the same manner and that every one would be able to enjoy this great invention to which the majority of the world was paying very little attention because it was limited to persons who understood the code. The time has come right now. My topic this evening will be, "Is Radio a Fad?"

I say radio is not a fad. It is in its infancy. We have just begun to learn how to use radio. It will only be a matter of time when radio will be a permanent form of entertainment the same as a player piano, phonograph, etc., are in the modern homes of to-day. It will pass these competitors as it is not limited to entertainment only, but can be used in a commercial and educating way. Just think of a typical evening entertainment before a radio receiving-set. A throwing on of the switch puts your radio set in operation probably bringing in a bedtime story for the children, broadcast from one of the leading radio firms in your own city. Then a turn of the dials brings in a popular piano selection broadcast by a large music house or newspaper thousands of miles away. Turning of the dials again bringing in the latest news reports, opera or a prominent lecturer, lecturing on an educational topic thousands of miles in another direction. And it will be only a matter of time when the turning of these same dials will bring in your own Congress in session discussing the laws of the country. Imagine all this being done in your own parlor with windows and doors closed picking all

JOBBERS AND DEALERS!

THE SOUND WAVE CORPORATION still has some territory open for jobbers and dealers. We manufacture a quality line of

VARIOMETERS VARIOCOUPERS DIALS

and any other molded articles.

On September first we will have ready for delivery an inexpensive **LOUD SPEAKER** that has no equal at any price.

Inquire at once for prices, terms and territory

THE SOUND WAVE CORPORATION

30 GRAND AVENUE,

BROOKLYN, N. Y.

"EURACO" MICA GRID CONDENSERS AND LEAKS

Price 60 cents
(Designed to fit Standard Grid Leak Base)

**GRID LEAK
VALUES:**

.5—1.0—1.5
2.0—2.5—3.0
Megohms

Price, 60 Cents



**COMPACT,
INTER-
CHANGEABLE,
HANDY,
MOST
EFFICIENT**

"Euraco" Condensers are composed of Copper Sheet and Best Grade India Ruby Mica, and are entirely Hand Made.

Manufactured in following capacities:

.000025 Mfd—Correct for Myers Radio-Audion RAC-3
.0001 " —For Special or Experimental Circuits
.00025 " —Correct for Super-Hetrodyne & UV 201
.0005 " —Correct for Radiotron UV 200

Condenser—Leak Mountings

Bakelite Base with Single Mounting\$.40
Bakelite Base with Double Mounting60
Bakelite Base with Triple Mounting80

SHIP OWNERS RADIO SERVICE CO., DISTRIBUTORS

1342 East 22nd Street,

EUROPEAN RADIO COMPANY
Manufacturers

BROOKLYN, N. Y.

Interesting Proposition to Dealers

SEABOARD

QUALITY

PRODUCTS

ECONOMY

**Sturdy
Construction
Perfect
Insulation
Special Shaft-
Contact Bearing
Adjusted, Tested
and Inspected
Before Shipment**

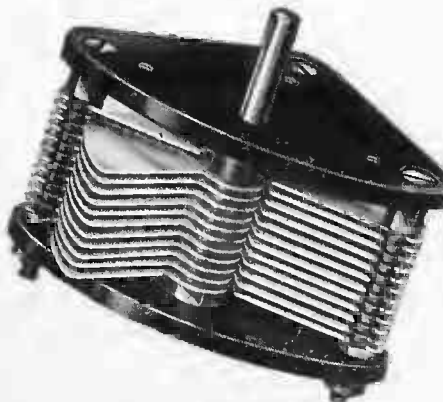

**23 Plates
Capacity .0005 Mfd.
Dependable
Efficient
Guaranteed
Low Price**

PRICE \$3.00

No. 1 Variable Condenser for Panel Mounting

IMMEDIATE DELIVERY

JOBBERS AND DEALERS—WRITE FOR DISCOUNTS

SEABOARD RADIO CORPORATION

266 GRAND STREET
NEW YORK CITY

ELCO RADIO SUPPLY CO.

*Manufacturers'
Distributors*

2728 Broadway, New York City

**Attention
Radio Dealers
and Jobbers**

40 and 10

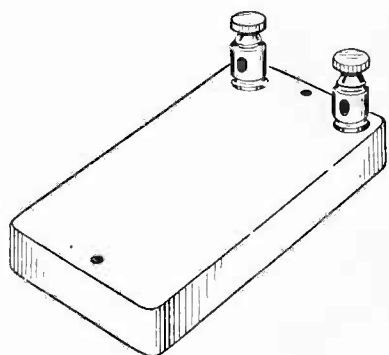

Serco Fixed Condensers,
moulded, 70 cents

Serco Fixed Condensers,
moulded, 90 cents

Serco Crystal Detector, \$1.25

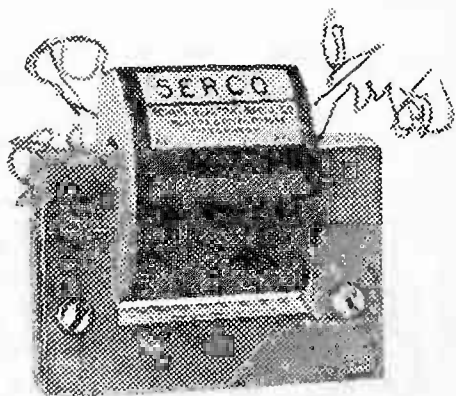

Serco Amplifying Trans-
former, 10 to 1 ratio, \$3.50

We are Manufacturers
of
Serco Radio Products

Write us about that special 40 and 10

Scheib Elec. Radio Co.
6243 Station Street
Pittsburgh, Pa.

this out of the air. This is not a dream. They're not doing it in the movies. But we are all doing it now. Therefore from what I have told you during this short talk you can judge for yourself, and I am sure you will agree with me that radio is bound to remain as a permanent entertainer, newspaper and educator as well. And put itself in the modern homes of today and the future. It's being a fad as we hear on the streets and in public places. As long as we have news, we are bound to have radio. When news dies, radio dies and we all die with it.

Mr. EDWARD G. EGLOFF,

Technical member of the Radio Club of Illinois, at the National Radio Exposition, Leiter Building, Chicago, Ill.

VETERAN IN RADIO

Another to turn his practical experience in the late war to the development of Radio is Major C. B. Cannon, head of the firm of C. B. Cannon & Co., Chicago, distributors by mail.

Major C. B. Cannon during the recent struggle was chief of telephone and telegraph research for the A.E.F. in Paris. Before the war, however, he had spent more than twenty years in telephony and radio work.

A complete catalog issued by the C. B. Cannon company shows that they are wholesale distributors for the Jones Radio Company and other manufacturers. The line includes receiving sets and units, variable condensers, head sets and bands, batteries, phonograph attachments, loud speakers, jacks, tube sockets, rheostats, transformers, dials and knobs.

The policy of the company is to market by mail, orders being sent to retailers C.O.D. Everything is guaranteed, the company claims, and only reliable manufacturers' goods handled.

CANARY ISLES RADIOLESS

American manufacturers of radio broadcasting or receiving devices might just as well pass up the Canary Islands as a market for their instruments. There is not a chance, says the Consul, particularly on the remote island of Gomera, to compete with the "whistling language" of the natives. The inhabitants of this island by use of a system of whistling signals can convey bits of news and information over considerable distances with great rapidity. The system dates back hundreds of years says the consul's report, consequently radio telephony is practically unknown.

**THORNTON
AUDIO FREQUENCY
AMPLIFYING TRANSFORMERS**

Supreme Test Transformer

These transformers are supplied in either mounted or unmounted types. Special attention paid to the manufacturer of receiving sets.

**THORNTON
TRANSFORMER CO., Inc.**
30 Church Street, New York City



PRECISION

GRID LEAKS AND MOUNTINGS

Resistance ranges from .05 megohms to 5. megohms. Accuracy guaranteed.
Grid Leaks 75c
Mountings 50c

Radiophone Equipment Co.
45 New Street Newark, N. J.

**It pays to advertise—ask
our advertisers.**

**If you have something to sell the Radio Trade, fill in the blank below—
an ad this size would only cost \$18.60 per issue on contract**

ADVERTISING ORDER

THE RADIO DEALER,
1133 Broadway, New York City.

You may insert our advertisement, copy attached, in the next 12 issues of the RADIO DEALER, to occupy space of six inches, for which we agree to pay you at the rate of \$18.60 per issue.

(Signed)

(Address)

(City and State)

Minimum order, four inches

Newark's Exposition

Big Radio Show Promised for Big Radio Centre

Newark's Second Annual Radio Show is to be held on the main ball-room floor of the Robert Treat Hotel on October 4, 5, 6 and 7th, and is expected to repeat its first successful performance of last April.

The promoters of this enterprise, who successfully staged the first show last spring, promise some exceptional surprises. The Amateur Radio Construction Contest will be held as before. This event which received the plaudits of the crowd who attended the first show. Silver loving cups will be awarded the prize winning sets.

It is again expected that silver trophies will be awarded to the smallest set, the largest, the most unique set, etc.

Booth arrangements at the radio show while duplicating in a measure those of the last show, will afford more room for visitors and ample space for exhibitors to display their new apparatus.

Newark boasts of two of the finest radio broadcasting stations in the country and visitors to the show are assured of continued and varied programme throughout the four days of the exhibit.

Show Director Edward Siegelson promises his audience a new series of motion pictures to demonstrate the operation of radio waves and the action of the vacuum tube and says that he will invite the participation of the national guard with their radio apparatus to demonstrate their prowess to the crowd.

Quoting from a recent circular about the show: "As one of the premier centres of radio in the country, and as a matter of fact, the parent city as well, is no more than fitting that the Newark Radio Show should outrank all others in points of attendance and interesting displays.

NEW LOUD SPEAKER

The Autovoix, made by the Autovoix Company of Baltimore, is a loud speaker with several special features.

The Autovoix is built on the lever principle, with but one movable part other than the diaphragm. It does not require attention or adjustment after being installed. This instrument, the makers claim, is beyond the experimental stage, for it embodies the patents of the Magnaphone, an instrument used for a number of years for loud-speaking purposes other than radio work.

RADIO CABINETS

WE MANUFACTURE A COMPLETE LINE OF RADIO CABINETS, OF MAHOGANY, WALNUT, OAK, AND WHITE WOOD, IN ALL SIZES, AND IN ANY FINISH. BEST OF CONSTRUCTION. DIRT, DUST AND MOISTURE PROOF. QUICK DELIVERIES—QUANTITY PRODUCTION PRICES. SEND US YOUR SPECIFICATIONS, OR A SAMPLE OF YOUR CABINETS, AND GET OUR PRICES.

CABINET WORK SINCE 1900

ESHOO CABINET WORKS

635 HERKIMER ST.
BROOKLYN, N. Y.

TELEPHONE
LAFAYETTE 2324

Phone Harlem 3067

2378 Third Ave., at 129th St., New York City

SCHEUROTH LETONITE CO.

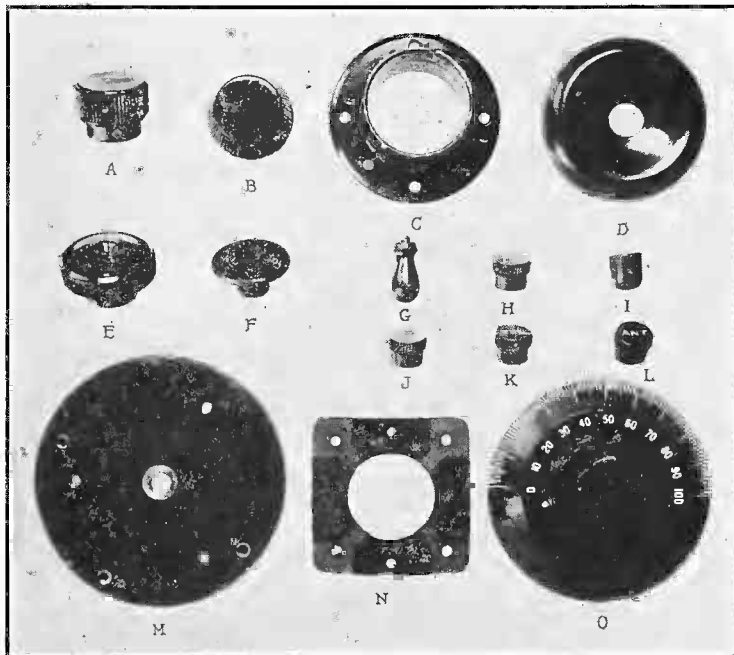

MANUFACTURERS OF

Radio Specialties

MOULDED PRODUCTS OF EVERY DESCRIPTION

Send in Your Blue Print Specifications

Prices on Application

HIGH HEAT RESISTANT

"LETONITE"

A FEW OF OUR STOCK PARTS

Delivery Immediate

ALSO MADE IN CONDENSITE, BAKELITE OR REDMANOL

TONKS VARIABLE CONDENSERS

Every condenser tested before leaving factory and guaranteed to function properly

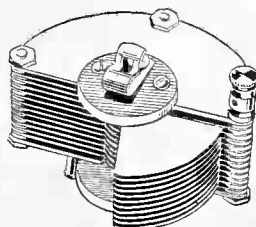

Air Type

13 plate—.00025—\$3.00
23 plate—.0005— 3.50
43 plate—.001— 4.25

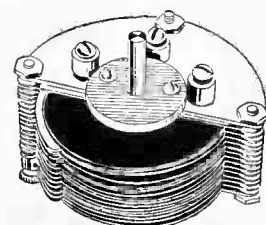

Insulated Type

Ideal for Amateurs
13 plate—.0005—\$3.40
25 plate—.001— 4.00

Distributors Write

Only One Wanted in Each Territory

TONKS MFG. CO.

16-22 BOYDEN PLACE
NEWARK, N. J.

TUNING COILS

Cross Weave Tuning Coils the heart of a receiving set just the coils for bringing in the Radiophone Broadcasting stations 180-500 Meters. Price \$1.25 each, or set of three coils Primary, Secondary and Ticker Coils, \$3.50 per set with circuit diagram.

CONDENSERS

Phone and Grid built of the best material obtainable. Price \$1.00 each.

MOTOR-GENERATOR SET

250 Volt DC 175 Watt Generator and 110 Volt AC 60 Cycle (Any Cycle) Motor. The best there is. Price \$78.00 complete.

AERIPHONE

The wireless telephones. Price \$35.00 to \$300.00.

PANELS

Treated with a special process made by us. Will not Warp or Shrink and is not affected by Temperature changes. Waterproof and possesses High Dielectric properties. Easily machined and will not Crack or BREAK. Looks as good as Bakelite. We are prepared to ship promptly the following sizes:

6" x 6" x 1/4" thick.....	\$.60
6" x 7" x 1/4" thick.....	.75
6" x 10 1/2" x 1/4" thick.....	1.00
6" x 12" x 1/4" thick.....	1.25
9" x 12" x 1/4" thick.....	1.50
9" x 14" x 1/4" thick.....	1.75
12" x 14" x 1/4" thick.....	2.20
12" x 21" x 1/4" thick.....	3.00

Strips 3 1/2 x 6; 3 1/2 x 8, \$.40 each; 3 1/2 x 10, 3 1/2 x 12, \$.60 each; 3 1/2 x 18, \$.75 each.

Add postage for 1 lb. for Panels up to 6 x 12 x 1/4; and 2 lbs. for larger sizes.

We will be pleased to quote prices on these panels cut to a different size on receipt of your specifications. NO FREE SAMPLES.

NATIONAL RADIO CO.
MARSHALL, MINN.

THE KENTONE RADIO AMPLIFYING HORN



Made of brass, highly polished and nickel plated. Fifteen inches high, six inch bell

RETAILS FOR \$6.00

Write for particulars

F. C. KENT CO.

IRVINGTON NEW JERSEY

The Radio Situation

Prepare Now to Take Advantage of Fall Prospects

By E. F. DURKIS

The radio situation as it is today is nothing to be alarmed at. True, it is, that sales have fallen off quite a bit, but this is what has always happened. Sales this fall should be better than ever because of the increased public interest, because of the lowering of prices of quite a few items which has been brought about by the advent of quite a number of new manufacturers, because of newer and additional broadcasting stations and mostly because of the faith that we all now have in radio itself.

The situation in general is much the same all over the country and should adjust itself very nicely by the fall. Too many small dealers and others have been astounded at the first profits in radio, and upon a hasty survey of the situation, entered into the field in a bigger way. Too many overbought naturally, in anticipation of reaping real large profits, with the result that all along the line everyone bought a bit too much. Too many ordered recklessly with the results that manufacturers went ahead on a certain schedule only to be deluged with cancellations and refusals of shipments. Of course, quite a large number accepted the goods and played their part of the game the best way they could, which was admirable and deserved real praise.

Radio this fall is bound to be better than ever—yes, healthier than ever. Who will not have had the chance during the summer months to plan and plan wisely? And so all along the line every one is having a chance to feel his way and feel it right. But let us not all be asleep. At any time when sales are lowest, bargains are always ever presenting themselves. The market today shows quite a few and should be an incentive to those who can feel their way safely in absorbing some of them. As soon as we run into the fall season there will be a stiffening up of the movement of the supply of goods and while goods may not be as scarce as last year, still it will not be too easy to get everything one wants. Radio will be better this fall because we all know what we are talking about, and because we know what values are. There will be more complete sets than ever before, more parts available and the public more able to buy because of their increased interest, the ease of connecting up the apparatus, the great possibility of receiving without out-

We Specialize in

Brass Rod and Tubing
Sheet Copper, Aerial Wire
and Binding Posts

McKenna Brass and Mfg. Co.

First Ave. and Ross St., Pittsburgh, Pa.

'Phone, Court 637

Moss Radio Company

Jobbers in

Radio Sets and Equipments

202 West 23rd Street

New York City

Phone Watkins 5078

DEALERS

Have you tried "PRACO" Service?

We are distributors to the trade for all representative manufacturers, and specialize in the cutting of panels and tubing to your order.

Have you our latest price list and discount sheet?

PITTSBURGH RADIO AND APPLIANCE CO., Inc.

Desk D

112 Diamond St., Pittsburgh, Pa.

FRANKLIN VARIOMETER

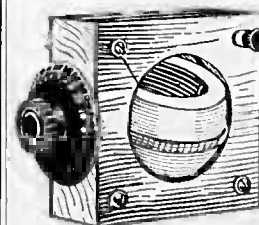

Made of select-ed hardwood. Permanent contacts assure smoothness of operation, unsurpassed by any other make.

Price \$4.50

Sample sent prepaid \$3.50

Dealers Write for Discounts

FRANKLIN RADIO MFG. CO.
711 Penn Ave. Wilkesburg, Pa.

side antennæ, and a multitude of other good reasons which all point the same way for a bigger, better and healthier business.

Christmas this year will surely be radio—no getting away from it, and radio will sure sell then. For the boys, the manufacturer who comes out with something novel in radio will be in a position to make real money, for most of the boys, no matter what their other hobbies are, will all take to radio—for to them it is so fascinating!

There will be a demand for everything in radio all through the fall, and naturally the best and most widely advertised articles through salesmen aids will hold themselves above the rest and so command the situation. There is no doubt that everyone will get their share and those giving real service in delivery, etc., will go a long way in getting more and more and holding same, for all time.

It will be wise and healthier for all concerned, to place orders for fall or future delivery now or as near in the future as possible, for then and only then can the manufacturer plan his way ahead in the most economical way, and so always be on the job when it comes to actual deliveries and service, and the earlier orders are received the most likely the lower the prices.

And so, after all, radio has come to stay, the possibilities ever increasing, with always greater possibility of increasingly larger sales because of newer developments, greater faith in radio and the continued push behind it all the time.

NEW RELIANCE CATALOG

The new catalog of the Reliance Electric and Engineering Co. of Cleveland, Ohio, covers their Type T Motors and is indeed worthy of comment inasmuch as they have told their story completely and with a method that should be copied by many in the Radio field. The use of word and picture and the sequence of topics defies the casual reader of catalogs to lay this catalog aside until he has studied every page.

PLANS FOR POLDHU

Poldhu, located in Cornwall, is one of the oldest and probably the best known of the European high-power radio stations. At the present time it is not being actively used and its eventual disposition is uncertain, although there has been some discussion of a plan to convert it into a radio telephone broadcasting station.

DEPENDABLE  LINE

DIAMOND :: QUALITY

PRECISION RADIO INSTRUMENTS

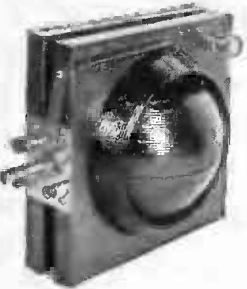

No. 41—VARIOMETER

TRANSFORMERS

CONDENSERS



No. 42—VARIOCOUPLER

CORRESPONDENCE SOLICITED

THE EASTERN SPECIALTY CO.

3551 N. FIFTH STREET
PHILADELPHIA, PA.

MR. RADIO RETAILER!

You **NEED** This Paper. Do you think it will be worth a dollar to get **THE RADIO DEALER** every month for the next year? Use the blank below, rubber stamp or print your name and address, then mail to us. Do it today.

HARRY M. KONWISER, *Publisher,*
The Radio Dealer,
 1133 Broadway,
 New York City.

Please send **THE RADIO DEALER** to the following address for one year
 for which { we enclose one dollar
 { we will send one dollar on receipt of bill.

(Name)

(Address)

(City and State)

Make remittance by check, money order or registered mail

DEALERS

Write to-day for your copy of
our new

RADIO CATALOG

Just Off the Press

It lists our

WONDER RECEIVING SETS RADIO-PLATE PANELS

and other radio parts and accessories
at prices that pay you a regular profit

Holloway Electric Supply
Co., Inc.

238 Third Avenue. New York City

VOLTA

PRODUCTS

VARIOMO-COUPLER.....\$3.85 List
No taps, the *only* coupler with
sharp primary tuning.

VARIOMETER.....\$3.25 List
Low distributed capacity, high
range.

CRYSTAL SET.....\$8.50 List
Sharp tuning, triple range.

VACUUM TUBE SETS

Write for Trade Discounts

VOLTA ENGINEERING CO.
172-4 Lorimer St. Brooklyn, N. Y.

STEVENS

R
A
D
I
O



P
A
N
E
L

W I N D O W

Patent Pending

Has met with instant approval wherever
shown.
An improvement to any panel and a neces-
sity for every dealer. Order your supply
now.

Black or Nickel Finish—Price \$1.00
Liberal Discounts *Distributors Wanted*



Dept. D

434 60th Street, Oakland, Calif.

What is a Jobber?

Trade Expresses Preference in
Regard to Jobbers

By JOHN R. HALL

Research Editor, The Radio Dealer

What really is a jobber?

THE RADIO DEALER has asked this question of several thousand manufacturers in connection with the national research into trade conditions now being conducted.

The large percentage of reports that carried answers to this question show that manufacturers are giving more and more thought to this matter. While the standards set up by one manufacturer differ widely from those set up by another, there seems to be a gradual tightening of selling policies, all pointing to an early adjustment of the jobber proposition.

Taking for matter of comparison thirty reports covering four articles, all but two of the manufacturers answered the entire list of question as to jobbers. Four stated that they considered as jobbers any firm who purchased in lots of a certain sum or over as long as the buyer asked for jobbers' prices.

Four others added the requirement that the jobber travel a certain number of salesmen, while one simply stated that proof in the form of orders from retailers must be shown before jobbers' discounts could be given.

Two objected to their jobbers selling by mail while three demanded that the jobber have no affiliation with a retail store of his own.

One firm required "credit ratings of the highest class," adding the note that out of sixty jobbers only two were new firms, all having been drawn from other lines of business.

One interesting point was that many of the manufacturers reporting are pointing out the way for better business by using the jobber as a means to effect sales rather than as a place to unload goods.

Out of a batch of twenty-three reports, covering different lines than above referred to, over half the reports specified that they sold only to jobbers, "going to the trouble to find a jobber to handle the sale when they received inquiries from open territory," as one man put it.

Nine reports out of town show a decided preference to selling through the jobber, although some of the reports received are from firms selling largely to manufacturers. Disregarding these reports it seems to be the general opinion of the trade that the jobber is here to stay. Factories employ exclusive representatives, and a small percentage of manufacturers having one specialty work the exclusive distributor end, but in almost every case the tendency is shown to favor the jobber in every possible way.

My conclusions on the reports received so far, which give a fair idea as to the general trend of opinion, is that the jobber will continue to be an economic necessity in the radio trade—that the jobber is here to stay.

WHITEHOUSE GRID LEAK

an efficient, constant, inter-
changeable and compact "Grid
Leak"—not affected by damp-
ness or temperature.

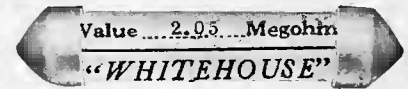

Made to fit any stan-
dard base, in values 0.5
to 3. Other values to
order. Price, 70 cents
each.

WHITEHOUSE RESISTANCE UNIT

a real Resistance Unit, con-
stant, interchangeable, com-
pact and non-inductive. Tem-
perature does not affect it—
made in any size to order from
(1 to 1,000,000) ohms.

Splendid Proposition to Dealers

Every one of the above tested and
guaranteed.

WHITEHOUSE
RADIO & MFG. CO.

311 - 89th Street

Woodhaven, Long Island, N.Y.

Dealer's Attention

WE HAVE QUITE A FEW SPECIALS

By paying cash during the slow
season, we have secured thousands
of dollars worth of Radio goods,
and are now selling same at a bigger
discount than you can get elsewhere.
Stock consists of:

V.T.1 and V.T.2 Army J & E Tubes
Variometers
Vario-Couplers
Variable Condensers
Binding Posts
Switch Points
Switch Arms
Sockets
Rheostats
Transformers
Phone Condensers
Crystals
Battery Clips
Battery Testers

and hundreds of other parts. Send
for special price catalogues. Our
terms 20% with order, balance
C.O.D., but you get the goods at a
BIG saving.

LIBERTY RADIO COMPANY

106 Liberty Street, New York City

References: Bradstreet, Dunns or Bank of
Manhattan Co., Rockaway Park, New York.

Questions and Answers

Conducted by A. L. KONWISER, B.S.

LaFollette State

Can you give me information as to the "conditions" in Wisconsin? How many telephone users? How many farmers? How many autos? Thanks.—Martin X., Pittsburgh.

Martin X. is hereby advised that Wisconsin has 190,000 farms and 100,000 automobiles; that sixty per cent. of the farms have telephones and about 15 per cent. gas or electric light. There are more dairy cattle in this State (2,750,000) than in any other State in the Union. Less than 15 per cent. of the farms in Wisconsin are rented. Yes—a goodly State that can assimilate a lot of radio equipment.

Parasites

Some of the so-called "big" radio manufacturers haven't expended one cent for broadcasting. Others have. Why should there be any "parasites" in this industry? Talk that up. These same big-fellows retard every effort at organization, it would seem. They don't want "shows," they don't want "publicity" of this and that type, because of their "divine right" ideas. Go, bang, at these "divine right" chaps. This will include some radio companies and certain journalistic morons of the electrical trade.—Eugene Scanlon, Morscan Radio Co., Newark.

Thanks, 'Gene—you're giving us a big order, but we'll oblige you—starting with the next issue. Just watch the old speed stuff go forth. We're in training right now and almost on edge.

Radiophone

Can you advise me whether the term "Radiophone" is copyrighted?—Mark Wolff, N. Y. City.

The word "Radiophone" is, so it is advertised, claimed as a trade-mark.

That Volstead Act

Would you say that a "speech" urging the repeal of the Volstead Act should be broadcasted from our station? We believe the local people are about fifty-fifty on the repeal of this act. Please do not use our name in connection with anything you may say about this.—Broadcasting Station, N. Y. State.

Our advice, despite our personal hope for light wines and beer, is not



No. 410. Cut 3/4 Size.
Pat. Applied For

"THE BEST  IN RADIO"

This new panel mounting Rotary Dial SWITCH is absolutely the BEST. Just what you're looking for. Fully Guaranteed. Money back if you are not satisfied.

LIST PRICE \$1.00

Very Attractive Proposition to Dealers and Jobbers

VIRGINIA RADIO CORPORATION

Manufacturers—Jobbers
Charlottesville, - Virginia

INDUCTANCE

SWITCH

Catering to Jobbers and Distributors Exclusively. Unusual Discount Rate

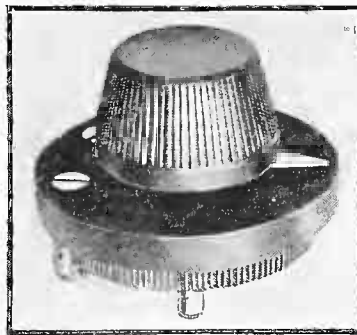

Switch, Complete, 50c. Without Contact Points and Stops, 35c.

6 Ohms, 1 1/2 Amp. FILAMENT

RHEOSTAT

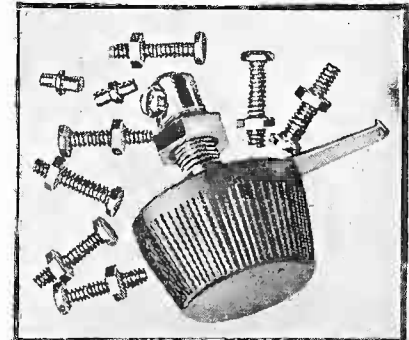

List Price, \$1.00

ACORN RADIO SUPPLY CO.

15 WEST 30th STREET

NEW YORK

RADIO PANELS

And other insulation for Wireless Work

BAKELITE-DILECTO

Grade XX Black was used by the Government during the war for this purpose. It is the

Standard of the World

THE CONTINENTAL FIBRE COMPANY

NEWARK, DEL.

New York, 233 Broadway
Pittsburgh, 301 Fifth Ave.
Los Angeles, 411 S. Main St.
Seattle, Wash., 1927 First Ave., South

Chicago, 332 S. Michigan Ave.
San Francisco, 75 Fremont St.
Rochester, N. Y., 85 Plymouth Ave., South

JOY-KELSEY CORPORATION
 Manufacturers
RADIO EQUIPMENT
 4021 West Kinzie St. Chicago Ill.

WOOD PARTS
 Variometers, Cabinets, Rotors, Coil Ends,
 Etc.
 Mill Established 1849
 Lowest Prices
THE R. C. MILLS
 Executive Offices 30 E. 23d St., N. Y. C.

BUY DIRECT
for greater profits
ROGERS RADIO RECEIVER
 Type B, complete short wave
 tuner detector and two stage
 amplifier in mahogany cabinet,
 no jacks, rear connections, list
 \$60.00. Liberal discounts.
Rogers Radio Co.
 5133 Woodworth St. Pittsburg, Pa.

LOOK WHAT WE HAVE TO OFFER
 Variable air condensers, no junk, 43
 plate, list at \$4.00
 Variable air condensers, no junk, 23
 plate, list at 3.00
 Discount, 50% of the list price.
 Rheostats and Bulldog Plugs for immediate
 delivery.
 Ducon aerial plugs and Novo Batteries,
 always on hand.
TUBES
 UV 200 and UV 201, U. S. Signal Corps
 Tubes, VT 1 and VT 2 also in stock.
 Western Electric Loud Speakers and
 Magnavoxs.
Liberal Discounts to Dealers
 Small orders receive the same attention
 as large orders.
 Write—Wire
WHITE RADIO CO.
 141 West 33d Street New York City

**KNOCKDOWN
 APPARATUS**
 Variometer with brass fittings, boxed.
 Variocoupler with brass fittings,
 boxed.
 Crystal set with complete instruc-
 tions for hook up and assembly.
 Rotors, stators, and coil ends always
 on hand.
Write for circular and discounts
RITTER WOOD WORK CO.
 118 Walker St., New York City

**Radio
 Salesman**
 wanted for middle west territory.
 One with experience and following to
 handle high class line.
Excellent Opportunity.
 Address Box H-14, THE RADIO DEALER
 1133 Broadway, New York, N. Y.

to permit any "speech" on the pro-
 posed modification of the Volstead
 Act. The Keith vaudeville circuit, by
 the way, has just prohibited their
 acts from joking on prohibition. It
 is a good policy in broadcasting *not*
 to take sides.

Sitka Spruce
 Can Sitka Spruce be used for radio
 cabinets? Is there much Sitka spruce
 wood in America?—S. A. Frank,
 Boston.

There is. The total stand of Sitka
 spruce in America is estimated at from
 40 to 44 billion feet. One-third
 occurs in Alaska, one-third in British
 Columbia and one-third in Washing-
 ton, Oregon and California. It is a
 premier air-craft wood. It is very
 desirable for musical instruments and
 that must include radio.

The Mengel Company tells us that
 spruce is not generally used for fine
 cabinet work. Mahogany and walnut
 have always been the favorite woods
 of the cabinet makers. Mahogany is
 not only used because of its fine ap-
 pearance but also because it is a de-
 pendable wood. It does not crack or
 warp as readily as other woods.

According to the Mengel Company's
 observation, most radio cabinets are
 made of mahogany or else birch, which
 is stained to look like mahogany. The
 Mengel Company does not operate in
 Sitka Spruce itself, and cannot say
 definitely whether it is used or not in
 musical instruments. They say defin-
 itely, however, that the phonograph in-
 dustry, the piano industry and the ra-
 dio industry generally buys mahogany
 in the form of lumber or finished parts.

Dealers who want catalogs should
 notify our service bureau.

**RADIO MANUFACTURERS AT
 ELECTRICAL SHOW**

The wireless department of the
 New York Electrical and Industrial
 Exposition, to be held Oct. 7-14, at
 the Grand Central Palace, promises
 to be interesting.

Among the concerns which will ex-
 hibit according to the show manage-
 ment are the Radio Corporation of
 America, the Weston Electrical In-
 strument Company, the Continental
 Radio Corporation, the Pioneer Radio
 Company, Disbecker & Co., John
 Firth & Co., Electric Service Engi-
 neering Company, V. Himmer, Jr.,
 Shelton Electric Company, Multiple
 Storage Battery Company, Electric
 Storage Battery Company, Sleeper
 Radio Company and the Norman W.
 Henley Publishing Company.

EVEREADY
RADIO "A" BATTERY
Immediate Delivery from Stock
 Manhattan
Storage Battery Co., Inc.
 204 West 76th Street
 New York City

Maclite Vario-Coupler
 Price \$5.00
 Is, in the opinion of experts, the most
 efficient on the market.
 All Other Maclite Parts are equally effi-
 cient, including the Maclite Variometer,
 Double Slide Tuner, Variable Condensers
 and Crystal Detectors. The Maclite Sin-
 gle Tube set at \$25.00 is the best buy we
 have ever seen. Let us tell you more
 about this set, also all other Maclite
 parts.
 Dealers and Jobbers Write for Discounts
MACLITE RADIO CO.
 701 Maclite Bldg., Claredon St.
 Boston, Mass.



The EMBE Variocoupler
 List Price \$4.50
 Attractive Trade Proposition
 Manufactured by
Marvin B. Fallgatter
 Waupaca, Wisconsin

**GUARANTEED
 QUALITY** radio sup-
 plies at **LOW PRICES**
 and **PROFIT** allowing
 discounts.
 Variometers \$3.75 up
 Vario Couplers..... 2.50 "
 Vario Condensers.. 2.00 "
 B Batteries..... 1.75 "
*Wire, Parts and Supplies
 Special Purchasing Service*
**McConnell Cable &
 Specialty Co.**
 426½ S. Clinton St., Chicago, Ill.

Radio Exposition

Milo E. Westbrooke Makes Interesting Announcement

Announcement is made by Milo E. Westbrooke that the Second National Radio Exposition will be held at the First Regiment Armory, Chicago, January 16-20. Mr. Westbrooke staged Chicago's first radio show last May.

Many features of prime interest to the exhibitor will be inaugurated at this show. The armory has many handsomely furnished company rooms. The construction of the building, built to withstand siege in time of war, renders these rooms sound proof. These quarters will be utilized as special demonstration rooms. Exhibitors who desire to show prospective customers how their sets will get long distance reception will be enabled, in these rooms, to give private radio concerts without any outside interference either to detract the attention of the customer or impair the hearing of the concerts. Interested people may be taken from the exhibit booths on the main floor to the private demonstration rooms.

As at the first show, Manager Westbrooke will regulate the loud speakers so as to eliminate the noise which might interfere with the business at the exposition. Mr. Westbrooke was highly commended by the press and the exhibitors for the efficient way in which he handled this situation at the June exposition. Profiting from this experience, the second national exposition will show a marked improvement along these lines.

Another feature, as it was in the first, will be the participation of the schools. The high school boy is not only looked upon as the radio manufacturer of the future, but he is the surest vehicle to carry radio into the home.

The school exhibit at this exposition will be on a more extensive scale than at the first show. There are twenty-four high schools in Chicago, and already the students in all of these are working on the exhibits they will display. There are radio clubs in all these institutions, and the leaders of these organizations will take an active part in the school participation. The schools will have actual working exhibits showing how radio sets are made in the school work rooms by these juvenile wizards of electricity.



SUNSET

Tuner and Detector

List Price \$11.00

200 MILE RECEIVING RADIUS

Dealers write for discounts

Jobbers write for discounts and territory

ARONAX RADIO SALES CO.

Sole Distributors For

SUN RADIO CO.

1114 S. Michigan Ave. Chicago, Ill.

Immediate Delivery

Variometers

Vario-Couplers

Panel Mounted

and

Unmounted



Vacuum Tube

Detector

and

Amplifier

Panels

DEALERS—Simplex Products Move Fast

JOBBERS—Place Your Orders at Once

SIMPLEX RADIO CO.

1013-15 Ridge Avenue Philadelphia, Pa.

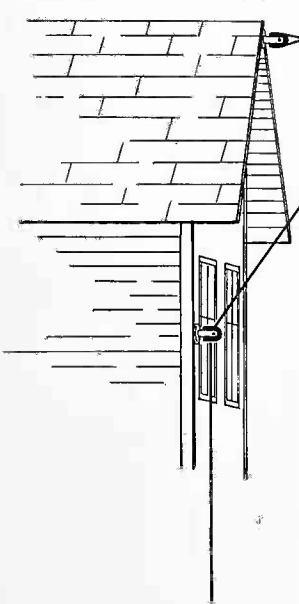



The Peirce

190 for Radio Use

A COMPLETE UNIT
The screw, bracket and insulator are assembled in a complete unit, ready for use.

EASY TO INSTALL
The One Ninety fits the hand like a screw driver. A jab, a few turns, and it's in.

DURABLE
The metal part of the bracket is completely hot galvanized. The insulator is made of the best grade of brown glazed porcelain.

LOW COST
The cost of the One Ninety complete, is no more than that of other insulators without screw or bracket.

HUBBARD & COMPANY, PITTSBURGH

THE PORTABLOOP

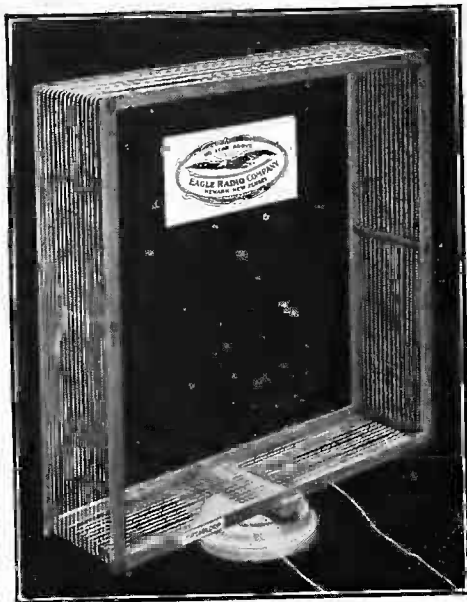

Size 24"x27" overall

You will have
to stock it.

Why not order
before the rush
while prompt
deliveries can
be made?

List price \$10.00.



212 Central Avenue

Packing of Sets and Parts Need Your Careful Attention

By B. D. BROWNE

Secretary and General Manager of Mercury Radio Products Company,
Little Falls, N. J.

In this age of reconstruction of business methods and elimination of out-of-date practices, the packing of goods for shipment is an extremely important end of merchandising which is all too often overlooked by the manufacturer.

A satisfied customer is the best asset of any business, and yet so many business houses run a needless risk of losing that asset by shipping goods inadequately packed. You may make good any direct loss which a customer might have due to this cause, but considerable sales effort must immediately be expended to restore that merchant to his former contented frame of mind. Records show that railroad companies in the United States paid out \$105,000,000 during 1919 alone for loss and damage of shipments, more than half of which was traceable to poor packing; but no one can estimate the additional millions spent in correspondence and personal interviews before the troubles were adjusted to the satisfaction of all parties. Moreover, statistics do not show how many of these customers transferred their accounts to other manufacturers when the smoke had all cleared away.

Too much stress cannot be laid upon the importance of careful packing of wireless instruments and parts. It is rarely the cabinet or panel that is damaged but more often the delicate knob and dial or the binding post that projects beyond the face of the set that receives the shock and jar that causes breakage. Shredded paper or excelsior is cheap and it affords ample protection without damage to the finish of the instrument. Some method should be employed to protect the contents from moisture. A heavy wrapping paper will answer the purpose in most cases for domestic shipment and will spare the dealer from having to display a water discolored container on his well arranged shelves.

The weak features of the crate itself may be too few nails, nails not of sufficient length, or nails driven in end grain or in cracks, thus greatly reducing their holding power. For a heavy box it is often wise to use a cement coated nail, as its grip is some 30% greater than a smooth nail; 15% to 40% is the average loss of efficiency

by over-driven nails, due to crushing of the wood fibre by the head.

Straps of unannealed steel properly placed will not only strengthen the box but will greatly reduce the probability of loss through pilfering. None of the light fingered gentlemen will long contemplate a box so sealed.

Some thought should be given to the even distribution of the weight in the box. Keep the center of gravity as near the center of the box as possible, and if the total weight is more than 300 pounds it is good policy to construct tape handles to assist in handling.

Stop now and appoint a week of your time for your packing department, giving to it the same thought and concentration that you have given sales or production or advertising. The writer feels sure that it will be time well spent and will result in substantial savings in the future.

It is to be hoped that we radio manufacturers will not fall behind others in doing our share toward promoting the idea of safe transportation of merchandise.

AMBOY RADIO SHOP PROGRESSING

The Amboy Radio Shop, successors to Beck and Brody of Perth Amboy, has leased a part of the National Pharmacy at the corner of Smith St. and Madison Ave., Perth Amboy, where Mr. Brody will continue an exclusive radio store. Like a good many wide awake dealers he believes that it pays to carry only radio equipment and drop the side lines.

DEVICE ON RADIO SETS

C. E. Wilton, of North Eighth Street, Philadelphia, holds several patents on articles that interest the radio manufacturers. He has, for several years, marketed to phonograph manufacturers a patented cabinet lid support which is proving of great worth to manufacturers of phonograph cabinet type Radio sets. The lid support is self-locking, and closes automatically by slightly raising the lid before pushing it down.

**Trade - Mark
Department**

Conducted by Chauncey P. Carter, Trade-mark Specialist of Washington, D. C.

NEW RADIO TRADE-MARKS

Part I—Accepted by Patent Office P S C on seal-Power Supply Co., Terre Haute, Indiana.—First used December, 1919.

BOLDO—Martin Schweibold and Jacob Schweibold, Philadelphia.

CONNECTICUT — Connecticut Telephone & Electric Co., Inc., Meriden, Conn. Used not less than one year.

Part II—Registered in Radio Dealer Trade-Mark Bureau

ARCO—American Radio Company, P. O. Box 133, Baltimore, Md.—First used May 5, 1922.

THE MULTILISTENER

The Multilistener is the invention of Edward Moore, an engineer well known in the automobile and truck industry, and who for the past several years and until recently has been identified with the engineering division of the Splittorf Electrical Company who have an international reputation in things electrical, and especially apparatus pertaining to electrical ignition.

Ed. Moore has had considerable experience in developing sound conveying appliances and the Multilistener represents his most recent contribution to the radio industry and provides ways and means to successfully utilize one set of head phones so that several persons may listen-in at the same time.

The Multilistener is for use with both crystal and tube sets and being mounted upon a tripod of nickel-plated brass and adjustable to a height of several feet, the instrument may be arranged in a convenient position for the several persons listening-in.

The F. C. Manning Company, of Newark, N. J., with whom Ed. Moore is now associated, are manufacturing and distributing the Multilistener. In the development of the Multilistener to its present high standard of efficiency and usefulness, F. C. Manning, president of the company, has contributed several of its best features.

Ask Our Service Bureau

Binding Posts — Contact Points

Knock-down Detector Sets

**VARIABLE
CONDENSERS**

with patented adjustable tension

JOHN A. COZZONE & CO.

61 Arlington Street

Newark, N. J.

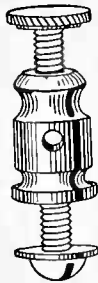

**Trade-Marks Secure Trade
Registrations Secure Trade-Marks**

I Secure Registrations

CHAUNCEY P. CARTER

Radio Trade-Mark Specialist

4907 Potomac Avenue, N. W. Washington, D. C.

Correspondents in all countries



“PRAMCO”

TRADE MARK



Not merely a SWITCH POINT or BINDING POST, but the BEST. A superiority of workmanship and finish that eliminates all quality competition.

Assure your future business now. Articles with the name “PRAMCO” stamped on them need no apology.

PREMIER RADIO MFG. CO.

1900 No. 6th St.

Philadelphia, Pa.

Switch Points, Binding Posts, Crystal Cups, Detector Posts, Switch Levers, Etc.

Dealers and Jobbers get our quotations

McTIGHE ALKALINE STORAGE "B" BATTERY

for *RADIO OUTFITS*



The McTighe Storage "B" Battery is the most satisfactory for radio use. It gives 22 volts, is inexpensive—noiseless—cannot be damaged by short circuit, overcharging, standing idle or unchanged. Can be fully charged from any light socket for less than one cent. Is furnished in an oblong glass which nests neatly.

The McTighe Rectifier is cheap, simple, durable, and effective, and should be used when charging the McTighe "B" Battery.

Battery \$5.00 Rectifier \$1.50 Rubber Filler 25c
F. O. B. Irwin, Pa. Prompt shipments.

ECONOMIC APPLIANCE CO.
IRWIN, PENNA.

THE ATWATER KENT AMPLIFIER

During the coming season much interest should center around the compact two step amplifier put out by the Atwater Kent Manufacturing Company, of Philadelphia. The unit which embodies the same high quality of the company's other radio and automotive products is easily connected in any type of circuit where audio amplifiers are required. Its compact neat appearance is shown below.

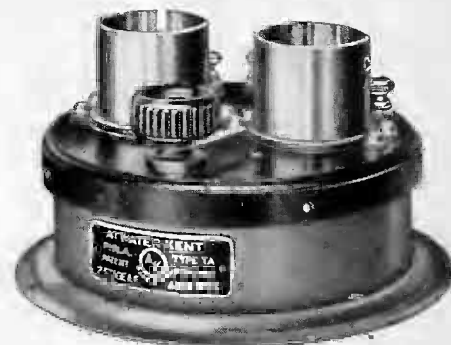

The excellent amplification is accomplished in small stages by adjusting the single rheostat arm. This means the elimination of jacks and the quick jump from amplification below requirements, to the excessive point usually found when the plug is placed in the next stage.

The transformers are shielded in a steel case protecting them from mechanical and electrical disturbance. They are also hermetically sealed in this casing so that all moisture trouble is eliminated. In a reported quality test the unit was submerged in water 24 hours, taken out, drained and placed in a circuit with performance unimpaired.

The connections are short so that capacity effect is reduced to a minimum and strength made inherent. Its perfection is the result of many experiments. It is sold at a very moderate price, made possible through quantity production and the 25 years' experience which the Atwater Kent Company has had in the manufacture of electrical instruments.

MANUFACTURERS!

If you have not seen a copy of

The Radio Dealer Weekly

write for one today

Address: The Service Bureau
The Radio Dealer

1133 Broadway

New York City

Red Star Head Phones

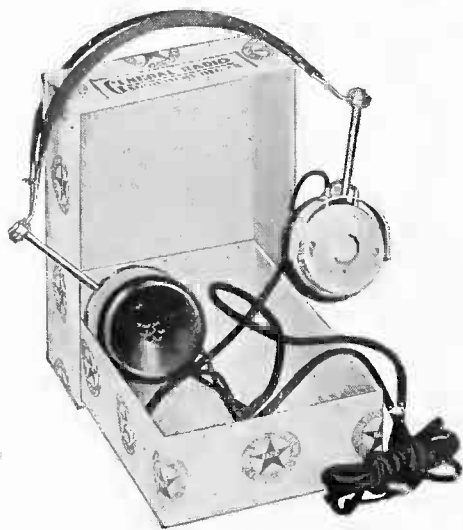

There is no more important link in the Radio Chain than the phones—poor phones often cause a set to be considered unsatisfactory, while good phones bring up the same set in good shape.

RED STAR HEAD PHONES

are the results of many years experience and the satisfaction that they are giving has resulted in the receipt in the last few days of a large number of re-orders for immediate shipment.

Monocoil	2000 ohms	\$5.00
Long Distance	3200 ohms	8.00

Complete with head band and 6 ft. of cord

Packed in attractive display boxes.

Liberal discounts—write for names of some of our satisfied distributors.

GENERAL RADIO EQUIPMENT MFG. CO.

1131½ Diversey Parkway

Chicago, Ill.

EVEREADY DISTRIBUTER MOVES

The Manhattan Storage Battery Company, Inc., distributors of the Eveready Storage Battery, formerly located at 204 West 76th Street, New York City, has announced its removal to larger and better quarters at 511-13 West 50th Street, the same city. The new location is entirely on the ground floor, and being much larger than the old quarters, will enable the company to greatly improve its service.

American Radio Exposition

Numerous Activities Planned for Christmas Week Exposition

Announcement has been made of the plans for the American Radio Exposition, to be held in Grand Central Palace, New York City, from December 21st to 31st, next, under the direction of the American Radio Exposition Company, of No. 120 Broadway. Radio apparatus, accessories and materials will be exhibited by manufacturers and dealers and there will be daily orchestral concerts, numbers by Grand Opera artists, broadcasting, illustrated lectures and other entertainment and educational features, the company announces.

The practical uses of radio and the principles on which it operates will be explained through the medium of motion pictures and by actual demonstration of apparatus.

Sound-proof rooms for the demonstration of loud-speaking devices will be constructed by exhibitors, each room to have a window opening on the street or areaway so that it may be ventilated without interfering with the demonstration of other apparatus.

Various other activities are now being planned by the officers and directors of the company. They are Frank Hitchcock, president; Walter Gordon Clark, consulting engineer of New York, vice-president; Harold Bolster, head of Bolster & Co., New York, secretary and treasurer; George Brokaw Compton, of the New York law firm of Peaslee & Compton, and Chester Humphrey, vice-president of the Old Colony Trust Co., of Boston, directors.

The schools and colleges being closed for Christmas week will permit the young folk to attend and participate in the activities as well as the great number of out-of-town folk who come to New York for the winter holidays.

"The exposition will cover the entire field of radio comprehensively," the company states. "Not only will manufacturers and dealers be represented but also many inventors and amateurs. Included in the program will be special activities of interest to radio fans and prospective buyers of apparatus. An information service will be established at the exhibition and orders for equipment may be taken on the premises."

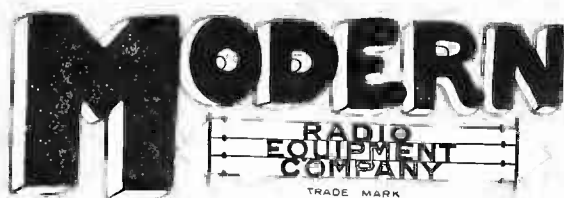

ESTABLISHED 1911

The Original and Genuine Mica Diaphragm Amplifying Loud Speaker

LIST PRICE \$28.00

CHEAPER THAN THE WORTHLESS IMITATIONS

SPECIFICATIONS

HORN: Seamless brass, triple lacquer, scientifically correct. Gives a rich, clear tone, not a metallic rasp.

AMPLIFYING CHAMBER: Exclusive "Modern" amplifying chamber of machined aluminum, polished and lacquered.

RECEIVER: Highest grade mica diaphragm amplifying receiver, built like a phonograph reproducer.

BASE: Oak wood base finished in early English, green felt bottom.

POST: Eby patented binding post.

NO BATTERIES ARE NEEDED TO OPERATE THIS LOUD SPEAKER—JUST CONNECT IT TO YOUR SET—PRESTO—HEAR 'EM ALL OVER THE HOUSE.

This is the original and genuine loud speaker—designed to do the work of a loud speaker—and is not an empty horn or shell that "any" receiver fits.

The Makers of the "FIRST" are Makers of the "BEST"

HORNING EXPERIMENTAL LABORATORIES

Sole Distributors of "Modern Apparatus"

Elizabeth Trust Company Bldg.

ELIZABETH, N. J.



Want to Buy Radio Equipment?

Ask Our Service Bureau

See Page Eighteen

KEYSTONE

FILAMENT RHEOSTAT

V. T. SOCKET

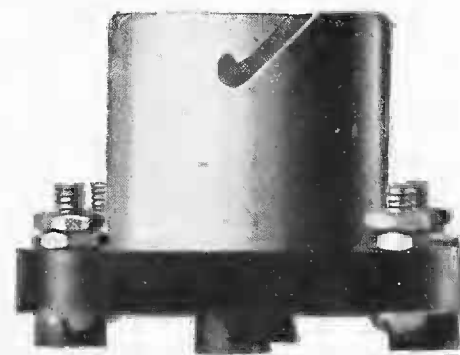

Resistance, 6 Ohms.
Carrying Capacity, 1½ Amps.
Base, made of black moulded Bakelite.
All parts made of brass and nickel plated.
Large Knob, and polished pointer.
List Price, \$1.00

BASE and feet of moulded natural color Bakelite.

Contact Springs, Heavy Phosphor Bronze, Heavy binding post.

Tube of heavy, polished Aluminum.

All brass parts nickel plated.

List Price, 90 Cents

Dealers and Jobbers, wire or write for discounts—Immediate Delivery

MANUFACTURED BY

KEYSTONE RADIO COMPANY

GREENVILLE, PENN.

Dept. D.

DEALERS ATTENTION!!

Most complete licensed crystal set in market—RADIOPHONA No. 1—equipped with 23-plate condenser and loose coupler. Includes Mesco double headset and aerial equipment. Buy direct from manufacturer, save money and make big profits. Write for prices and discounts.

M. P. RADIO CO.
453 W. 53rd St. New York City

Distributor of

**"MIRACO" "MUSIO"
EMPCO PLUGS AND JACKS**

"Heco" Insulator and Switches
Dealers, Send for Catalogue and Discounts
DETROIT RADIO CO.
1 West 34th Street New York City

The Comet Battery Co.

Manufacturers

Radio "B" Batteries

Cleveland, Ohio

PATENTS

ELECTRICAL MECHANICAL
RADIO

SEND SKETCH AND DESCRIPTION
FOR OPINION

EMIL ALEXANDER KERN
328 SOUTH SEVENTH STREET
NEWARK, N. J.

Variable Condensers

SEMI-CIRCULAR TYPE

	List
43 Plate.....	\$3.75
23 Plate.....	3.00
11 Plate.....	2.75
3 Plate.....	1.50

BALANCE TYPE

.001 Mfd.....	\$5.50
.0005 Mfd.....	4.75
.0025 Mfd.....	4.00

SQUARE LAW TYPE

.0015 Mfd.....	\$6.50
.001 Mfd.....	5.50
.00075 Mfd.....	4.50
.0005 Mfd.....	3.50

Montrose Mfg. Co.

1200 Bedford Ave. Brooklyn, N. Y.

RADIO FREQUENCY UNIT

The Crosley Manufacturing Company, of Cincinnati, Ohio, has produced a new radio frequency unit that is said by radio engineers to be 100% efficient. The Crosley Company has adopted the name "Radio Frequency Tuned Amplifier" for the new unit, and is already producing them on a large scale. Naturally, the idea is to add one step of tuned radio frequency to the detector unit. Most efforts along the line of radio frequency amplification have been confined to the use of an untuned radio frequency transformer, working efficiently over a very narrow band of wave lengths. But the new Crosley unit, being tuned, works efficiently over a band of wave lengths ranging from 200 to almost 600 meters. This is accomplished by use of the Crosley Variable Condenser, operating in conjunction with a fixed inductance, both having extremely low resistance. Consequently, the interaction between the capacity effect of the condenser and the inductance, as well as external body capacity effects, are reduced to a minimum, permitting easy tuning, impossible with any other type of variable control of a tuned radio frequency amplifying unit.

When a Crosley radio frequency unit is used in conjunction with a detector unit, an amplifier tube is used in the detector unit, with the grid leak and condenser bridged, or short circuited. The detector tube then is placed in the radio frequency unit, which then contains the radio frequency tuner, detector tube and its control.

The radio frequency amplifier increases the range and volume of the Harko Senior, the detector unit manufactured by the Crosley Company, at least ten times, making it far more efficient, easier to tune and giving to it a much greater range.

ROGERS RADIOMETER

The Ludwig Hommel and Company of Pittsburgh are distributors of the Rogers Receiving Radiometer, a new type variometer which differs greatly in appearance and construction from the present unit known as a variometer. The Rogers unit takes up but a fraction of the space of the ordinary variometer measuring but 4" in diameter and 1" in depth. It occupies but little more space than the average rheostat. For long distance, short wave sets, two Radiometers will give excellent results. The Rogers unit can be used in any part of the circuit where the ordinary ball type variometer can be used.

SOCKET-RHEOSTAT

Registered U. S. Patent Office



TYPE A-5 ohms, suitable for detector bulb\$2.00
TYPE B-2 ohms, suitable for power bulb\$2.00
TWO IN ONE—A socket and rheostat so combined as to form a single unit.

No more unnecessary leads between socket and rheostat. Just connect your leads to the four posts marked P F G and you are hooked up as far as the SOCKET-RHEOSTAT is concerned.

MANUFACTURED BY

AJAX RADIO CORPORATION

Telephone, Bigelow 4097
538 South 10th Street
Newark, N. J.



Paragon Potentiometer

Easier, More Minute Control of "B" Battery

With the Paragon Potentiometer the filament plate potential is easily, exactly adjusted. What was formerly a difficult, wasteful operation is now simplified and economized.

Saves Batteries

The resistance of the Paragon Potentiometer, 300 ohms, is 50% greater than most potentiometers. Can safely be left connected across the terminals of the six-volt lighting battery.

Just What Everybody Wants

You know that such apparatus *does* sell well. This improved instrument will sell even better. The Paragon name keeps 'em moving across your counters. Write for discounts and catalog.

E. M. WILSON & SON

Paragon Distributors
11 Lafayette St. Newark, N. J.

TILLMAN PRODUCTS

Efficient Apparatus the Result of Diligent Work of Radio Engineer

The new line of Tillman improved radio products manufactured by Wm. J. Millard & Co., New York City, show some important features which tend to individualize their products. This has been accomplished by the diligent work of their Radio Engineer, Thomas Shearman. Their first product is a new potentiometer with an absolutely free and silent moving lever, and a patent three unit binding post, which accomplishes the following:

First—Acts as an efficient binding post.

Second—Acts as stop preventing the lever from running off the wire.

Third—Acts as a clamp firmly holding the resistance unit in place.

Another article of merit is a 180° vario-coupler with a wavelength range of 145 to 700 meters when used in conjunction with an antenna of .0002 micro-farad capacity. Silk covered wire is used on the stator and rotor, both of which are of bakelite, thus insuring maximum efficiency; they are also recessed, thus preventing the wire from coming loose.

Another novel feature is the doing away with taps, thereby insuring an attractive appearance. The taps are taken from the inside and brought out from the bottom of the stator in small pins which are fastened in the stator, thus preventing their coming loose.

The other articles consist of radio frequency transformers built upon new electrical principles and an audio frequency transformer with the silicon steel laminations entirely insulated from one another, thus minimizing hysteresis losses.

MERCURY INCORPORATES

With a capital stock of \$100,000, held by four Montclair men, the Mercury Radio Products Company, formerly conducted as a partnership at 51 Thomas street, Orange, has incorporated and moved its plant to Little Falls, N. J. The purpose of the company is the manufacture and sale of radio sets and equipment.

The incorporators are: Myron S. Shiels, president; Karl M. Jones, vice-president; Bayard D. Browns, secretary, and Edmund B. Osborne, Jr., treasurer; all of Montclair. Edgar Sisson, Jr., also of Montclair, is connected with the concern as radio engineer.

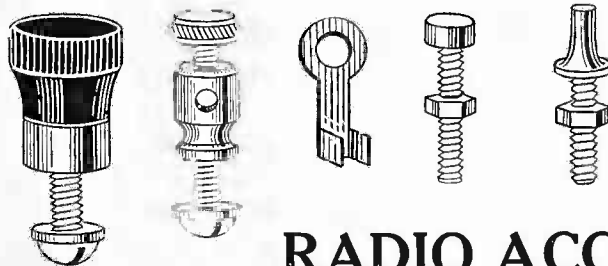

IMMEDIATE SHIPMENT

Also

All Other Radio Needs

WRITE FOR PRICE LIST

RADIO ACCESSORIES CO.

220 West 42nd Street

New York



Volton "B" Batteries

All sizes—plain and variable

22½ and 45 volts

Special Batteries made up on order

Representatives wanted in South and West—
Jobbers, write or wire for proposition

VOLTON BATTERY CO., INC.

MAKERS OF

HIGH GRADE BATTERIES

15 Lispenard Street

New York City

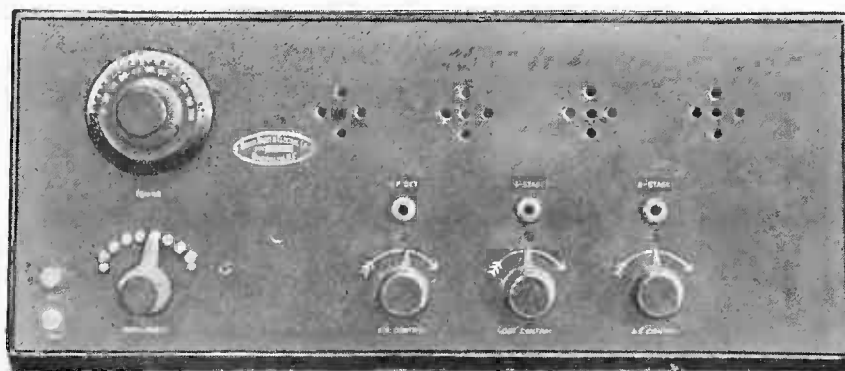

SYNTONE RECEPTOR-AMPLIFIER

"The easiest set on the market to tune"

THE radio business is here to stay. That is, it is here to stay for those dealers who are far sighted enough to sell only radio apparatus of known quality and serviceability.

The SYNTONE Receptor-Amplifier, type SJ-4, has been designed by our engineers, and is built with this idea paramount, of making your radio business permanent.

It has passed severe tests under the most adverse conditions for receiving broadcasted entertainment, with highly satisfactory results.

One of the outstanding features of this set that will make it sell to even the most discriminating purchaser is its easy tuning adjustment. Loud and clear reception is accomplished by the manipulation of a single dial.

LIST PRICE \$80.00

Liberal discounts to dealers also make SYNTONE a profitable set to handle.

*Write for complete details
today*

UNITED RADIO & ELECTRIC CO.

Makers of Quality Radio Apparatus

71 SIXTH AVENUE

BROOKLYN, N. Y.



2200 Ohms
List Price
Only
\$9.00

"East and West, the Globe is Best"

GLOBE RADIO HEAD PHONES

Highly sensitive Matched receivers Natural in tone. Each receiver tested by radio. Light weight (11 oz.). Comfortable to wear. Specially designed adjustable headband. Will not distort signals when amplified. Articulation is perfect.

There are many types of head sets on the market but not too many good ones. The GLOBE RADIO HEAD SET incorporates a knowledge of acoustics not possessed by other companies. It embodies correct design with the best of materials.

THE GLOBE PHONES ARE FOR THOSE WHO DISCRIMINATE.

Ask about the Globe Antenna Attachment Plug for using electric light wire

GLOBE PHONE MFG. CO.

EARL C. HANSON, Technical Radio Expert
Reading, Mass., U. S. A.

CLOSING OUT LINE OF HIGH GRADE DIALS

Special prices to clean up last four thousand of these.

Address Box 104, THE RADIO DEALER,
1133 BROADWAY, NEW YORK, N. Y.

States Radio Equipment

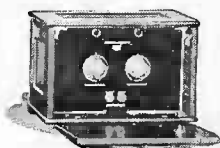
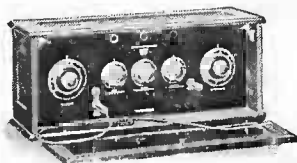

A radio receiving set is not sold after you have taken the order and delivered the goods. It has got to give service and this means the dealer has got to keep his customer satisfied.

States Radio Receiving Equipment stays sold—and does not compel the dealer to spend his profits in service.

The receiver unit contains one radio frequency—one detector and one audio amplifying tube. The

amplifying unit has two stages of audio amplification.

Both cabinets are solid mahogany with a piano finish. The panel has a highly polished, lustrous black finish, with silver plated lettering and dials.

Simple to operate—it is offered to you only after exhaustive tests have satisfied this company that this receiving set will give you the best results it is possible to obtain with any equipment.

Write for illustrated folder.

STATES RADIO CORPORATION

501 So. Jefferson Street

Chicago, Ill.

Nuloid a New Insulating Composition

German Discovery Admirably Fitted for Radio Use

Among the many Americans who toured Europe in the hope of finding something new that could be used in the radio field, were Henry & Max Durst and William S. Field. These folks being in the rubber business, found that a certain compound that they now call Nuloid, was being used extensively in Germany. This compound was invented in 1914, by a German chemist, and was used extensively by the German government during the war.

After a careful investigation, and long, arduous research work in their own laboratory, they discovered that the compound had wonderful possibilities, and that it could be made in all colors, and in any form, such as sheets, rods and plates or complete moulded articles, such as knobs, buttons and billiard balls. A scientific test showed that Nuloid was adaptable to the radio field. Certain qualities were found in this compound that lead them to believe it superior to hard rubber, or other insulating material. A test in the testing laboratory of Columbia University, showed, according to a report, that Nuloid resists a high frequency current of 23,300 volts, and is wholly unaffected by atmospheric changes.

Samples of Nuloid were sent to various firms in different lines of business, and reports show that Nuloid is easily worked, that it holds a high polish, that it does not warp and that it is oil and water proof.

The Nuloid Corporation, which holds the American patent on Nuloid, has its laboratory and plant in Kenilworth, N. J., and is headed by Henry Durst as president, Henry Goldstone as vice-president, Max Durst as secretary, and William S. Field as treasurer. Henry and Max Durst are connected in an official capacity with the Durst Manufacturing Co. of New York City. This firm manufactures mechanical rubber goods, and enjoys an enviable reputation throughout the United States.

The Nuloid Corporation announces to the radio trade, that it is anxious to have manufacturers of radio equipment submit specifications, so that they can show them how Nuloid can be used to advantage by progressive manufacturers who take pride in producing quality equipment.

PLYWOOD AND PLYMETL

The Haskelite Manufacturing Company of Chicago has recently introduced to the radio field a product of several years of research and study known by the trade-name of Plymetl. Plymetl is essentially a three ply water-proof panel known as Haskelite combined with a sheet metal face cemented firmly to one or both sides of the wood. Haskelite was perfected by the company during the war and has been used extensively for automobile bodies and various parts of passenger cars. The sheet metal cemented to the plywood Haskelite, is either a stretcher of levelled sheet metal treated for rust resistance or a thin sheet of copper. The thickness of this metal is about one-one-hundredth of an inch.

This Plymetl panel is particularly adapted to radio panels as the metal sheeting eliminates the trouble incurred by body capacity. The metal face is buffed so that the surface is smooth and permits of a high grade finish by the use of metal lacquer. Ordinarily the metal face is turned to the outside of the cabinet when used for the instrument panel of the radio cabinet. Plymetl is furnished in sizes desired by the customer, the commonest thickness being $\frac{1}{4}$ and $\frac{5}{16}$ of an inch.

NEW YORK COIL'S NEW SET

Among the recent radio receiving sets to be placed on the market is that of the New York Coil Company of New York City. The set which is known as the Entertain-A-Phone Receiving Set No. 2, consists of a tuner, detector and two stages of audio frequent amplification, all contained in a handsome hardwood cabinet. The transformers, condenser and variocoupler are the standard products of the New York Coil company. The circuit is a non-regenerative tuner guaranteed by the manufacturers to be entirely free from distortion and objectionable noises. A few of the features of the set are that the various parts are secured to the panel and an extra base, so that by loosening several screws the panel may be withdrawn without disturbing any of the connections; another feature being the provision for three separate sets of phones any pair of which may be put into use by turning a switch on the panel. The operation of the set, according to the manufacturers is as simple as that of the ordinary phonograph. The use of a loud speaker is also possible.

Want to buy anything? Ask our Service Bureau.

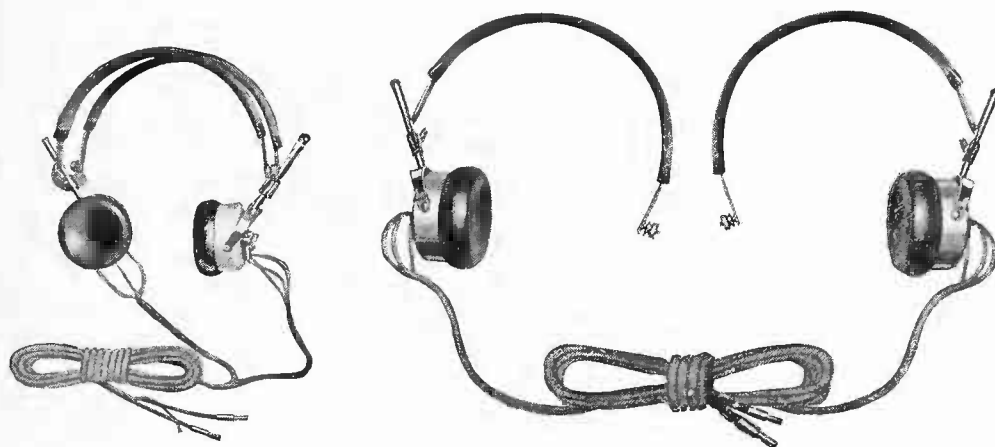

The Band Splits Into Two Parts. Each Having an Overhead Strip, Is Very Convenient for Two Persons

Premier Duplex

Phones

2000 Ohms \$6.50

3000 Ohms \$8.00

Discount to Dealers

PREMIER ACCESSORY & SPECIALTY CORP.

27 CONGRESS STREET

NEWARK, N. J.

TURNEY

A Name Synonymous With

QUALITY IN RADIO

THE TURNEY LINE consists of

- TURNEY Head-Sets, weight eight ounces
- TURNEY Sockets
- TURNEY Plugs
- TURNEY Spider-Web-Plex
- TURNEY Spider-Web-Duplex, complete with case
- TURNEY Amplifier Units
- TURNEY Multiplex, one step-amplifier
- TURNEY Monoplex, detector unit
- TURNEY Spider-Web Inductance Coils

A Real Line of Real Sellers

Some open territory for Distributors

*Write at once***EUGENE T. TURNEY LABORATORIES, INC.**

351 Sixth Avenue

Newark, N. J.

Philadelphia Pointers

By WM. B. WILKINSON, JR.

NEW GRID LEAK

Durham and Company, radio engineers of the Philadelphia Radiophone Company, have secured patents on a new variable high resistance grid leak that they contend will revolutionize the field in such condensers. The invention consists of a grid leak condenser to which is attached a plunger making it adjustable over a wide range. It is said to maintain its value permanently after an initial setting. It is non-inductive and has negligible capacity.

The Durham Variable High Resistance, as the new product has been named, consists of an insulating tube with metal ends, which is filled with an inert paste of the desired specific resistance. The plunger is inserted into this paste through one of the metal ends, the inserted distance being variable. The further the plunger is pushed in, the lower will be the resistance, and vice versa. These resistances will fit any standard grid leak base.

Another advantage of this form of grid leak is the many uses to which it can be put. It can be used as a variable grid-leak; a variable by-pass across phones or primary of transformer; a variable resistance for filter systems; or as a variable resistance for resistance coupled amplifier.

Durham and Company operate broadcasting station WCAU, which recently "put one over" by reporting the Leonard-Tendler fight to radio fans. Other Durham products are making their way into the radio field with great success on the basis of quality and workmanship.

"S & S" VARIOMETER

Sunday and Scholtz, of Cabot Street, have placed their variometers and vario-couplers on the market at a favorable list price. The policy of this firm is said to be a volume business at a low margin of profit. Their products, they firmly claim, are of quality unexceeded by any. They feel that their products will put radio in the reach of many who otherwise would find it impossible to secure high grade products. All "S. & S." products are guaranteed. This concern has been speeding up production in the slack season to take care of fall business.

CLOCK-LIKE PRECISION

Among well-known firms of allied industries that entered the radio field during the recent demand, was the American Chime Clock Company, of Germantown. Well known for the high standard of their time-pieces, this concern found their reputation, as well as the quality of their apparatus, was a great aid to them in merchandising their products. New units have been added to their line from time to time, and they are looking forward to doing a big fall business.

Among their products are a crystal set of unique construction and high grade workmanship, and a variable condenser, the die-work, and assembling of which has been handled by mechanics who have been trained for years on the highest grade of clock-work. The condenser bears all the ear-marks of a high quality product.

The line is being distributed by Lewis D. Breiting, of Germantown, under the trade-marks "Ell-Dee-Bee" and "Skytone."

"SENSORY" ARRESTER

The Heinemann Electric Company have issued a special circular on their new lightning arrester, which, with other Heinemann products, is marketed under the trade-mark "Sensory." The circular describes fully the method of installing, with a diagram showing the internal construction, and another showing the installation completed. This is a unique type of arrester, and comes in two styles, one for outdoor use, and a second special type for indoor installation in two colors. The arrester complies with underwriter's regulations, and is protected in full by patents pending.

The Heinemann Company has been known for many years as manufacturers of a complete line of electrical products of merit, and in entering the radio field last winter went about it in a way that would insure the same quality that has marked their electrical products for decades. Other Heinemann products of worth are tube sockets, insulators, indoor antennae, panels, ground clamps, variometers and couplers, detector and amplifier panels, cabinets for units and rheostats. Bulletin Number 12 of this company describes with the aid of cuts and wiring diagrams the complete "Sensory" line.

NEW RHEOSTAT

A new rheostat, modeled and manufactured by a firm of international repute, is offered to the trade by the Rubicon Company, of Walnut Street. Josef Doerr, of the Rubicon Company, in an interview, told of the function of this new article.

The new product is really a micrometer rheostat, quickly adjustable to any minute point in the six feet of resistance wire. Once obtained it is thrown off or on instantly without losing the adjustment. This fine adjustment assures maximum efficiency, and adds to the life of the tube. The rheostat is mounted without the use of mounting screws, requiring but one small hole in the panel.

The instrument has ample radiating surface and the wire has free access to the air throughout its entire length, which greatly increases the capacity. The resistance wire is wound on a non-shrinkable moulded porcelain core, resisting high temperatures. The resistance wire used also has a zero temperature coefficient, establishing the same resistance at every temperature. This rheostat controls either detector or amplifier tubes.

ENERGETIC WORKERS

Spiro Brothers, of the Real Estate Trust Building, are well known to the Philadelphia trade as energetic workers and reliable distributors. They offer a line of quality condensers of their own manufacture, and are national distributors of many well known lines. They are prepared to quote prices on all standard lines in lots from ten to ten thousand, and can sell manufacturers at a right price as well as the dealer and jobber. They are the sort of people, to quote a well known Philadelphia jobber, that it is a pleasure to do business with.

SPECIALISTS INCORPORATE

The Franklin-Mason Radio Company have recently incorporated for the purpose of manufacturing inductances, resistances, and capacities for radio circuits. By specializing in this field the new company hopes to fill the need in the radio trade for specialists who are competent to offer the best in one field. They feel that too many firms making one high grade piece of apparatus are only too liable to be car-

ried by their enthusiasm into entering an unknown field where they cannot attain their own standards.

R. T. Northcutt, who has spent many years in radio research work, is radio engineer for this company. Mr. Northcutt's experience dates back fourteen years, when he started his radio activity with the U. S. Navy.

The Franklin-Mason line will include wire resistances non-inductive, or of composition; choke coils, open core, closed core, or air core; fixed condensers; and transformers for inter-tube use, specializing in radio-frequency transformers, in which field they have a new design which they claim minimizes transformer losses and distributed capacity.

Philly Polyphases—

News Notes About the Folks in Philadelphia Radio Trade

The Pennsylvania Radio Laboratories, of West Philadelphia, are working on a set for which they claim great possibilities. They expect to place it on the market within the month.

Miller Lock Company have something up their sleeve which they claim will surprise radiotricians when they place it on the market. Mum's the word!

Machen Electric Company, of Bridesburg, are completing their line of accessories and parts before striking out after big fall trade.

Jobbers around town are smiling confidently as they see indications of a big fall rush beginning to roll in. Brother Gallagher of Stewart & Co. laughed especially loud and long when we mentioned the doubts of certain pessimists. Frank Chambers, of Chambers' Wireless School, with long experience in retailing and wholesaling wireless and radio supplies, expects to see things humming this month.

C. E. Wilton, of 231 North Eighth, is an enterprising phonograph dealer who has employed a radio expert to serve his radio customers. Mr. Wilton is an inventor and artist who holds several patents. Among his creations is an automatically locking lid support for phonograph cabinets which has several interesting patented features which make them especially suited for radio cabinets of the phonograph type.

(Continued on following page)

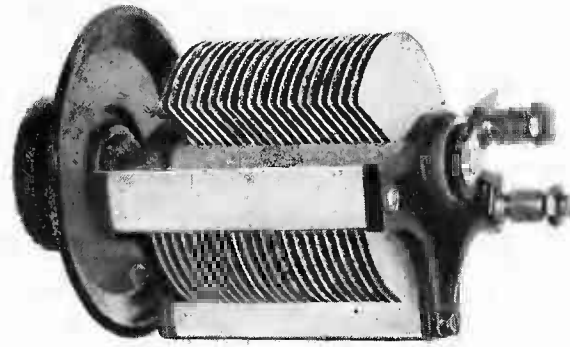

THE BAYLEY VARIABLE CONDENSER THOROUGHLY INSULATED

The 43 plates are assembled as a solid integral part of the whole, by the die cast process. Impossible for any plates to loosen in service. This is the condenser you need. Of good and pleasing design and high class workmanship, long bearings, insure true running. No side last.

Binding posts are drilled, and have tightening screws, lock nuts, and soldering points. Three ways to hook up. 3 inch dial and knob, with recessed white enameled degrees on black ground. Diagram label for panel, to show where to drill holes for spindle and screws, insuring without injuring the panel board.

Packed in strong box Complete without dial **\$3.75**

Dials, $\frac{1}{4}$ Shafts **75c** Extra

MONEY BACK GUARANTEE IF RETURNED IN SAME CONDITION AS WHEN RECEIVED WITHIN 10 DAYS

To Jobbers and Dealers, We Offer a Splendid Proposition

Write for Particulars to

BAYLEY CONDENSER COMPANY

105-109 VANDERVEER STREET
Telephone 0500 Glenmore

BROOKLYN, NEW YORK
Sales Manager, MYRON M. STUDNER

THE SPECIAL CHOKE COILS AND RESISTANCES

As used in the New Armstrong Super-Regenerative Circuit are ready for immediate shipment, at prices that will warrant your careful attention. Made by an old established company, whose

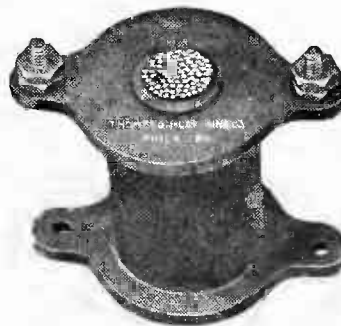

reputation for making the highest grade of Electrical Apparatus is world wide. For a Quality Product of Accuracy and Reliability these prices represent an Unequaled Value.

- .1 Henry Iron Core Choke Coil.....List Price \$3.00
- 5 Milli-Henry Open Core Choke Coil.....List Price \$2.50
- 10 Milli-Henry Open Core Choke Coil.....List Price \$2.75
- 12,000 Ohm Non-Inductive Resistance.....List Price \$3.00

WE ALSO ARE PREPARED TO SUPPLY

VARIOMETERS (BANK WOUND) UNIVERSAL PLUGS
VARIOCOUPERS (BANK WOUND) JACKS
VARIABLE CONDENSERS TELEPHONE HEAD SETS

Dealers Get in Touch With Your Jobber! Jobbers Write For Our Proposition!

THOMPSON-LEVERING COMPANY

RADIO DEPARTMENT
355 North 57th Street, PHILADELPHIA, PA.



ALCEMO

Sensitive Head Sets

4,000 ohm head set

FOR use on regenerative and bulb sets—extremely sensitive for long distance work. No matter how much amplification is used, this 4,000 ohm Alcemo can't be made to rattle. It is built to stand high voltages indefinitely. Ideal for use on the new Armstrong Super-regenerative sets. List Price.....\$10.00

2,000 ohm head set

For use with crystal sets—it brings even a faint signal in as though a regenerative set were being used. The volume and tone qualities have been pronounced by Radio critics to be the best obtainable. Each Alcemo phone carefully tested, calibrated, numbered and guaranteed. List Price\$6.00



The day of undependable radio products is over. Alcemo Head Sets meet every test of price and quality—fill out the coupon below for full information.

Alcemo Manufacturing Co.
Newark, New Jersey

ALCEMO MANUFACTURING CO.
Newark, New Jersey.

I am interested in your guaranteed Head Sets to retail at \$10.00 and \$6.00. Please send details.

Name

Address

Two well-known sporting goods firms not far removed from the shopping district are having a merry time of it slashing prices on radio merchandise in cut-throat competition. Overhead seems to be a neologism for aerial with both firms. Customers are wearing down the doorsill of both stores, however.

Among radio merchants in town are Evans' drug stores and National soda and drug stores. The departments are in charge of radio men of no mean experience.

The Electro-Dental Company are merchandising a high-grade line of radio parts. This is a well-known, long-established firm, and their line is well thought of by prominent dealers in Philly.

The new Thompson-Levering choke-coils and non-inductive resistances are finding a ready market because of the clamor of experts for the new Armstrong hook-up. This company is making a mark for itself in radio as it did in the electrical instrument field.

The Boldo Radio and Electric Company, of North Fifth street, have had great success with their midget receiver, and have placed several new machines in their plant to take care of increased production.

The Maxum Radio Company, of West Philadelphia, are preparing a complete line for fall trade, and expect to have their catalog and radio bulletin off the press in a short time. This concern is operated by the Fairmount Electric Company, a well-known electrical firm.

Emilio H. Velutini, D.D.S., an enthusiastic amateur who has been operating an amateur call station, has designed a variocoupler of worth that he is now producing for the trade. Dr. Velutini's experiences as a radio "bug" for several years has enabled him to design a quality product.

The Foote Mineral Company are finding a receptive market for their "Radio Twins," crystals which are tested and guaranteed.

The General Radio Company, of which Walter L. Eckhardt is president, has added to their line moulded articles of worth including insulators, variometers, vario-couplers, dials, tube-sockets, and crystal detector bases. These articles are being marketed under the "Geraco" trade mark. The company is distributing

MELCHIOR EQUIPMENT CO.

MANUFACTURERS OF THE SMALLEST TUBE SET ON THE MARKET

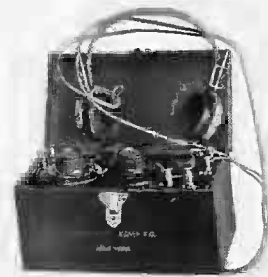

WE CAN FURNISH THIS SET IN PARTS READY TO ASSEMBLE AT VERY ATTRACTIVE PRICES.

We are ready to place on the market a knock-down regenerative hook-up set, consisting of a special variometer and variocoupler of a new design.

Some choice territory is still available for live wire distributors and jobbers

MELCHIOR EQUIPMENT CO.

306-8 E. 34th St.
New York City

the lines of Firth and Company, Dubilier, Thompson-Levering and several other high-class firms.

Capewell and Zoeller, makers of quality screw machine products, are doing contract work for radio in their line.

The Eastern Specialty Company have commenced the manufacture in large quantities of their variable condensers, a line to be marketed with their already well-known "Tesco" products.

Mr. Kramaroff, of the Precision Radio Manufacturing Co., announces the placing on the market of a high-class variable condenser. Several of the retailers in town have commented favorably on the article.

The Yankee Coil Company, of Stiles street, announce that they are ready to take fall orders on their line of variometers and variocouplers. These articles have received a hearty reception throughout the country, according to Mr. Coan, of the company.

Cheltenham's C. T. R. Radio products are well thought of in Philadelphia, as in all other parts where the name Cheltenham means quality and service. Right next door to the Atwater Kent plant on Stenton avenue, they have a plant at their disposal that can insure quantity deliveries on short notice.

Quaker Light Supply Company made no mistake in employing H. J. Dunbar, Jr., to take charge of the radio department. Mr. Dunbar is well known to the radio trade.

The Consolidated Electric Company, under the direction of W. McAvoy, are turning out radio equipment and accessories in quantity in their plant on North Thirteenth street.

GOOD PANEL BUSINESS

Poster & Company, New York City distributors of XX Bakelite Dilecto Panels report brisk business in that product among jobbers and dealers.

The company is undertaking to make immediate delivery on any quantity, cut to any specified size. The fact that this company does drilling and engraving on short notice, is helping to sell Bakelite Panels, because of the great convenience it affords the consumer, when he can have his panel not only cut to the correct size, but engraved and drilled, ready for mounting. The good points about XX Bakelite Panels are well known. It is positively guaranteed high in dielectric and tensile strength.

The MULTILISTENER

Saves the cost of additional Head Phones.
Provides listening facilities for EIGHT PERSONS.

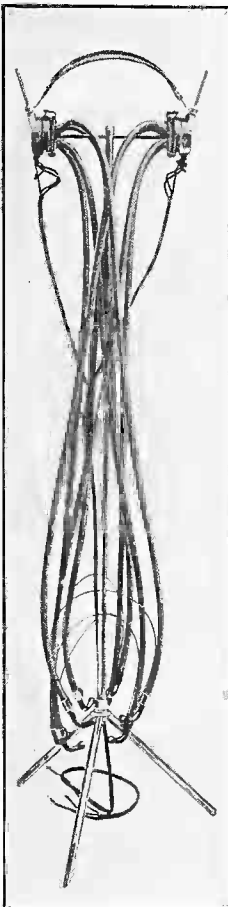

Complete with Adjustable Stand \$10.00 — 8 PHONES IN 1 — For Crystal or Tube Set

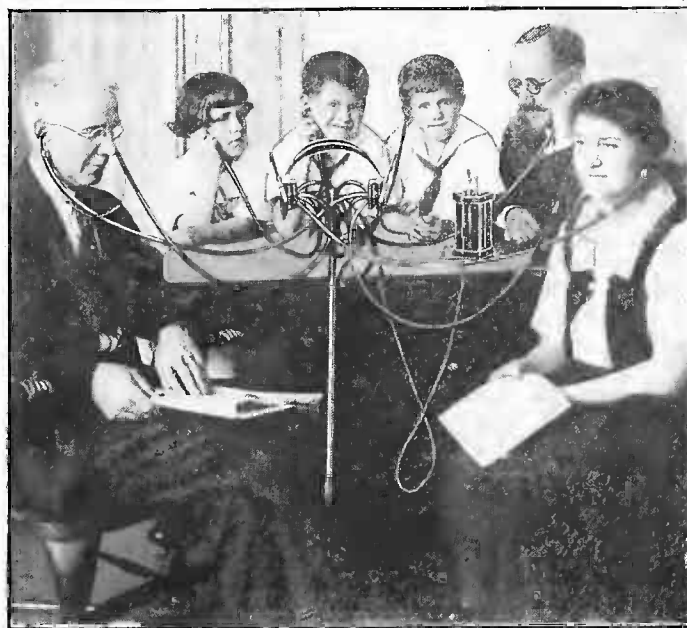

Comfort for the WHOLE FAMILY

Furnished with Rubber Ear Tips as shown, or with Ear Plates which do not enter the ear cavity (the external Auditory Meatus) at all.

Inquire of your jobber, or write to

F. C. MANNING COMPANY

Manufacturers

57-59 Spring Street, Newark, N. J.

ROSEMARK RADIO RECEIVING SETS



Rosemark Two-Stage Unit (Pat. Applied for)

Detector, One Stage, Two Stage, and Roseradiola Grand

THE SIMPLEST TUNER MADE

A Complete Line of Non-Regenerative Tube Sets at a Right Price That Bring Good-Will Orders

Every Instrument Tested and Guaranteed Against Electrical or Mechanical Defects

Tube Sets Built to Specifications Write for Attractive Proposition

ROSEMARK RADIO CORPORATION

Southern Distributor Wm. W. Moyle & Son Charlotte, N. C.

Manufacturers of Radio Apparatus 29 Lexington Avenue New York City

Mid-West Distributor Hi-Gee Radio Mfg. Co. Marion, Ill.

A VERNIER RHEOSTAT

It is doubtful whether, during the past few months, there has been scarcely a word more often used than that of Vernier. It is, indeed, an indication that manufacturers have been working hard to perfect the radio set of to-day and that they are anxious to give to the public a sensitive instrument. Radio has passed through the rough stage of its existence and daily, one reads of finer and more sensitive adjustments. It is in keeping with this progress that the Wald Electric Company of New York City has placed in the radio field a new rheostat known as the Microstat. The cut here shown explains fully the principle of construction. It is a seven ohm rheostat having a nichrome resistance

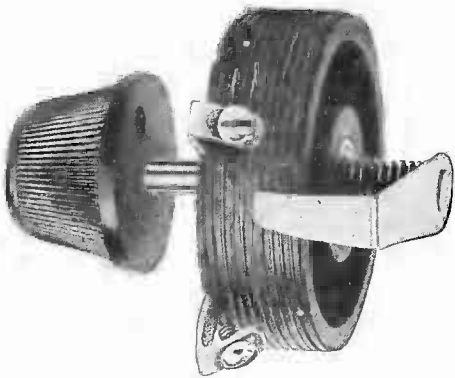

element. All moulded parts are made of high heat tested Thermolax and metal parts are heavily nickel plated. According to a recent circular instantaneous filament control can be obtained without having to guess for rough and fine adjustment. The Company also claims that the Microstat makes for reception as clear as a bell, and that noises which are generally mistaken for static or gassing batteries are entirely eliminated.

RITTER RADIO PARTS

The Ritter Radio Corporation of New York City, is now offering to the trade knock down crystal sets, variometers and varicouplers.

Complete instructions as to the hook up of the parts are furnished with each knock down set, which make it very simple for the radio fan to enjoy the making of his own set, and permit him to be reasonably assured that the set will work.

A SUPERIOR AUDIO FREQUENCY TRANSFORMER

USED AND
RECOMMENDED
by
LEADING
REPUTABLE
MANUFACTURERS
of
RADIO
APPARATUS

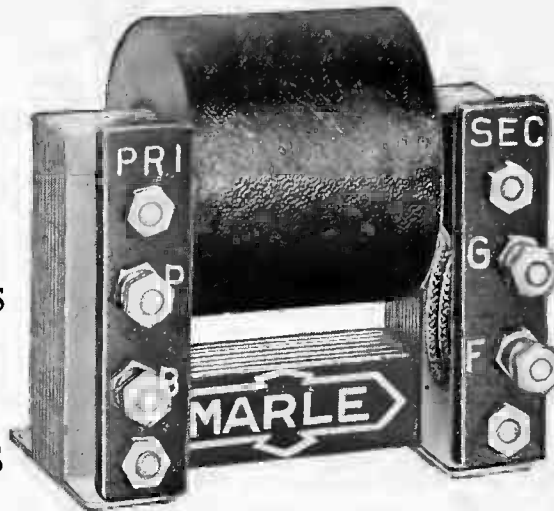

LIST
3.75
MOUNTED

Write for
Information
and Discounts

Jobbing
Concessions
Restricted

Manufactured by

MARLE ENGINEERING CO., ORANGE, N. J.

Special Prices Quoted On Unmounted Type To Manufacturers

CONDENSITE CELORON

Sets a New Standard in Radio Panels and Parts

Cut your panels from Condensite Celoron. This strong, handsome, jet-black, insulating material will give your customers a surface and volume resistivity greater than they will ever need. It is the ideal panel material because it machines readily, engraves with clean, cut characters and takes a high, natural polish or a rich, dull mat finish.

**Give your customers Quality
and they will give you orders**

Condensite Celoron—approved by the Navy Department, Bureau of Engineering—offers a sales opportunity unequalled to the live wire dealer who is keen on building his business on a quality basis. Write us today for our Special Dealer's Proposition and let us give you all the facts.

Diamond State Fibre Company

Bridgeport (near Philadelphia), Pa.

Branch Factory and Warehouse, Chicago

Offices in Principal Cities

In Canada: Diamond State Fibre Co., of Canada, Ltd., Toronto

Lattice Variometer

Estru Product Steps from Beaten Path in Form of Construction

The majority of variometers to date have been of the single layer framework type. A deviation from this method is the variometer manufactured by the Dalton, Whittier, True Company of Chicago, Ill. Manufactured under the trade name of Estru the variometer is lattice wound and occupies but 14 cubic inches of space back of the panel as compared with about 95 cubic inches occupied by the average variometer. It is about one-eighth the weight of the average variometer and has no framework of wood or other moulded material. This particular design of variometer, the company claims, produces as nearly as possible an ideal variable inductance, the measure of quality being represented by distributed capacity and low high-frequency resistance due to the method of winding. This assertion is based on the statement that an Estru grid variometer, at maximum inductance setting is only 30 micro-farads as compared with 180 micro-farads for a common wood block type. The Estru variocoupler is designed and constructed along similar lines to the variometer and matches it as to general size and appearance. The rotor is of the lattice wound type. The variocoupler is designed to operate with the lattice type variometer.

NON-FATIGUE HEAD SET

Those who have sat before a receiving set for an hour or more at a time will appreciate the light weight of the new Turney Head Set manufactured by the Eugene T. Turney Laboratories, Inc., of Newark, N. J. Fatigue is claimed to be a negative quantity with this 3,000 ohm, eight-ounce head set. The material used is of the highest quality obtainable, which makes for a sensitive instrument, having a low distortion constant. The Turney Laboratories have produced this head set as a result of years of constant intercourse with telephone receivers, and in placing it in the market they claim it to be of the best.

WANT CATALOGS?

Retailers and jobbers who desire Radio catalogs are advised to send their name and address to the Service Bureau, RADIO DEALER.

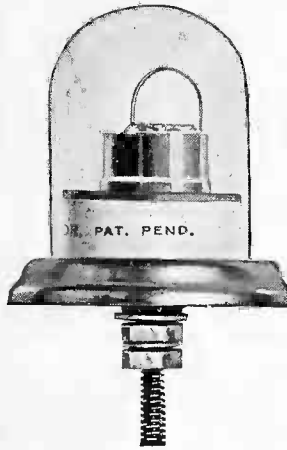

(Actual Size)

The One Outstanding Detector GREWOL

Nationally Advertised

A well-established product. Proven out in practical use under all conditions by amateurs everywhere. One fan recommends it to another. It pays to sell so popular an article.

A Good Proposition
For Every Radio Dealer

\$2

Permanent Adjustment

Always Set and Ready

Glass Enclosed

RANDEL WIRELESS CO.

Sole United States Distributors

9 CENTRAL AVE.

NEWARK, N. J.

!!!THE PREMIER RADIOVOICE!!!

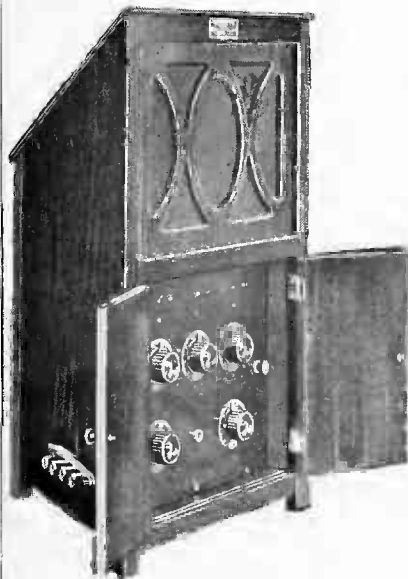

Is the first practical and commercial accomplishment of meeting the public's requirements and demand for a *Complete, Simple, Compact, Attractive and Efficient Loud Talking-Detector and 2-Stage Radio Receiver* at a Popular Price. Simple in Control — Wide in Range.

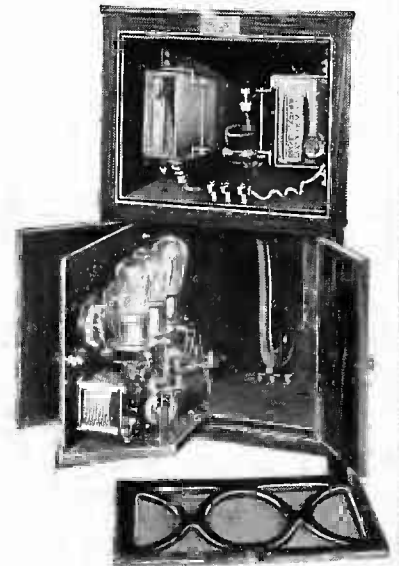

Mounted on a Bakelite Panel are

Premier Built and Tested Radio Condensers, Rheostats, V. T. Sockets, Transformers, Tuning Coils, Jacks, etc.; the panel being hinged within the beautiful 5 ply Mahogany Veneer Loud Talker Cabinet, measuring 21" in height by 12" in width, weighing, completely equipped with "B" Batteries and Loud Talking Phone as shown, only 17 lbs. Can be set in a corner of the living room, on library or end table, or on a piano, blending into the richest of furnishings with equal attractiveness. Price complete, excluding only bulbs and "A" battery—\$95.00.

Where an even lower priced equipment is desired, eliminating the phone and loud talker cabinet, our Type P' equipment, including "B" batteries, mounted in cabinet as shown, parts, hookup and panel being identical to that used in the Premier Radiovoice, is priced at \$55.00.

The Premier Radio Corporation is an old electrical manufacturing concern, which has turned its entire resources and equipment to production of high class radio parts and receiving sets. The Premier line is handled and is available to only the highest class of dealer, jobber or distributor, and to such is offered discounts to permit profitable merchandising. Descriptive bulletins sent on request.

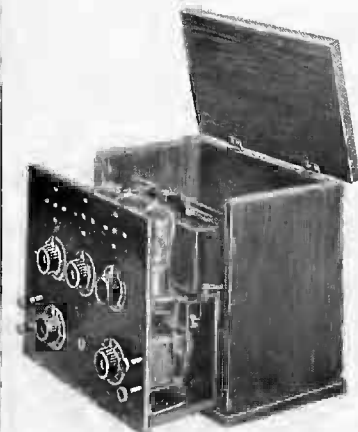

**Premier
Radio
Corporation**

6800 Bostwick Ave.
Detroit, Mich.



"Aerovox" Products



No. 1010 Rheostat

The Aerovox Rheostat assures double life to any vacuum tube set. It is well designed, mechanically perfect and very attractive in appearance.

A few interesting facts:

1. Base of molded insulating material of very high heat resistance.
2. Resistance element wound in hard fibre. It has a resistance of 6 Ohms and withstands a continuous current flow of $1\frac{1}{2}$ Amperes.
3. Phosphor bronze spring contact of ample size to prevent heating and still make contact on only one turn.
4. Adjustable to fit any size panel, $\frac{1}{8}$ to $\frac{7}{8}$ ".
5. Highly polished tapered knob conforming to latest advances in apparatus designed and rendering every operation.

*Certificate of Merit from
N. Y. Eve. Mail Laboratory*

*Jobbers, Attention! Wire
or write for open territory*

The
**RADIOLA
WIRELESS
CORPORATION**

208 West 17th Street
New York City

Perfects Receiver Without Aerials

A new radio invention that requires no aerial, ground wires, or outside connection of any sort has been perfected by David Grimes, a radio expert of Grasmere, S. I. The invention, which he calls the electronaire, is claimed, marks a new step in the development of radio receiving.

A series of demonstrations made recently before radio engineers, newspaper men and others have shown that the electronaire makes almost perfect reproductions of broadcast programmes. Practically all noise is eliminated, buzzing is done away with and the familiar "howling" of some radio receiving sets is completely prevented.

The electronaire, according to Mr. Grimes, is based on a new principle, which results in receiving original wave lengths with great strength and clearness. A receptor, the nucleus of the apparatus, receives wave lengths so keen and firm that the set can be heard clearly even in large rooms without amplification.

Noises are eliminated because with the electronaire outside wires are not required. Aerials tend to increase noise in reproduction because they pick sound waves from all directions. Loops do away with a great part of that noise, but still they reproduce all the sound waves that come from the direction in which the loop is pointed. "Howling" is caused by regeneration, and as the electronaire reproduces original sound waves instead of amplifying weak waves, that type of noise is also eliminated.

"Furthermore," said Mr. Grimes, "besides showing a marked ability to overcome static disturbances which put so many radio sets temporarily out



The Grimes Receiver

of commission, the electronaire is also free from static difficulties."

The electronaire is incased in a cabinet not unlike a music box. It consists of the receptor, the horn, and batteries. One of its features is an electric volume control by which sound can be reproduced in almost any volume without interfering with the quality of reproduction.

DICTOGRAPH LOUD SPEAKER

The Dictograph Products Corporation of New York City, well known to the trade as manufacturers of sound transmitting devices, have recently perfected a loud speaker that bids fair to rival the other popular products of this company. The loud speaking unit incorporated in the Dictograph Radio Loud Speaker is a specially devised loud speaking element. The design and construction is such as to permit of maximum amplification and the elimination of side tones, distortion, mechanical vibration and a metallic sound.



THE EAR OF THE WORLD

The Ear of the World is the title of a catalog recently issued by the Chicago Radio Laboratory of Chicago. The company is manufacturer of the well known Zenith products. The catalog is different from the average, as it appeals to the non-technical in a straightforward manner. No reference, except that noted below, is made to what lies behind the panel except to say that it is "good" and that to obtain the music and news broadcasted it is only necessary for the purchaser to know how to use the dials placed on the panel. It takes the average person away from the mysterious side of radio and leaves technicalities to the manufacturer to worry about. The company has taken for the keynote of its catalog, simplicity of installation and operation.

For the benefit of those who are interested in the technical side of the sets the company has devoted several paragraphs in the back of the catalog to a complete and clear technical description of each set.

WHAT WE NEED

The radio industry requires active broadcasting stations, to operate day and night service.—S. E. TEPPER.

AUTOMATIC'S HEAD SET

After many months of research and careful experimentation Automatic Electric Company, manufacturers of automatic telephone and switchboard equipment, has placed on the market a radio head set embodying some unusual features.

The Automatic Electric receiver is designed with a single powerful electro-magnet, which acts on the exact center of the diaphragm causing it to vibrate as a unit and not in sections, thus eliminating much distortion and false overtones.

In addition to this feature, the receiver is so designed that the voice current magnetism has an almost complete soft iron path, resulting in the reproduction of both weak and strong signals clearly, and without loss of power.

Attention is directed also to the fact that practically no consideration has been paid to resistance. Careful attention has been given to proper effective impedance and the design of the magnetic circuit, which are important factors.

Automatic Electric head sets are of standard size, but weigh only twelve ounces complete with head band. The shells and caps are of bakelite. The ear caps are designed for perfect comfort and maximum reception.

**RADIO PANELS
XX BAKELITE**

Manufacturers and dealers: Immediate delivery—
any quantity. Panels cut—drilled and engraved.
Ready for mounting

Write for free sample and prices

POSTER & CO.
552 SEVENTH AVE., NEW YORK
PHONE BRYANT 2572

THE NATIONAL TRADE SURVEY NOW BEING
PUBLISHED IN

The Radio Dealer Weekly

Should be of interest to

Every Manufacturer

Subscription to the WEEKLY
One Dollar the Year, payable in advance
Sample free on request

The Radio Dealer Weekly
1133 Broadway New York, N. Y.

List Price 75c

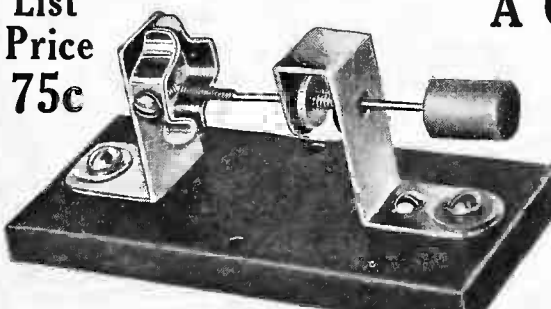

A CRYSTAL DETECTOR

Has universal adjustment permitting the entire surface of the crystal to be searched. Will maintain a constant pressure on crystal and cannot be jarred out of adjustment after setting. One piece crystal holder will accommodate either unmounted or mounted crystals. **List Price, 75c**

A VARIABLE CONDENSER

Made of hard aluminum plates. Special movable plates afford delicate adjustment on starting engagement and maintain proper rate of capacity increase throughout the range. Lock nut and double end conical bearings of dial spindle maintain positive adjustment and prevent short-circuiting. Heavy gauge metal end-plates afford superiority over material that warps.

List, .0005 Mfd.....\$3.75
List, .001 Mfd..... 4.75

Immediate Deliveries

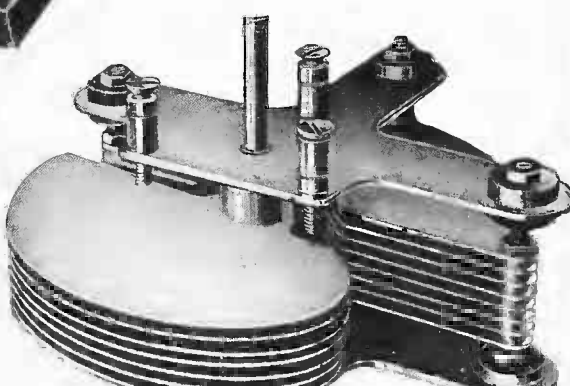

Write for Our Proposition

Our products tested electrically and mechanically and positively guaranteed.
Awarded the New York Evening Mail Certificate of Excellence.

DIAMANT TOOL & MFG. CO., Inc.
93 Runyon St. -:- Newark, N. J.

STRAHS ALUMINUM CO.
 announce their removal from 53
 Grand Street to much larger premises.
 New Address
 48 FRANKLIN STREET
 NEW YORK CITY

CABINETS
 Write for quotations
MARVIN B. FALLGATTER
 Waupaca, Wisconsin

Chaslyn Patented
 "Sink-or-Swim"
 Ball Battery Tester



Every user of an "A" battery needs it—and most will buy "on sight."
 Specific gravity shown instantly by sinking or floating of colored balls.
 Simple—Accurate—Won't break when dropped.
 Retail Price of Ball Tester, Water Filler and Depth Gauge, One Dollar.
 SPECIAL INTRODUCTORY OFFER.
 TWO sets for a Dollar to any recognized dealer, post-paid.
THE CHASLYN COMPANY
 4323 Kenmore Ave. Chicago

Best by Test!



Hundreds of manufacturers, dealers and owners of receiving sets everywhere have tested and found our crystals the most sensitive and efficient obtainable.
 Double your pleasure and increase the efficiency of your set by using our
ALL-SENSITIVE GALENA CRYSTALS
 Galena Crystal, Mounted - - 35c
 Galena Crystal, Unmounted - 25c
 IMMEDIATE DELIVERY
 Every Crystal
GUARANTEED PERFECT

Manufacturers, Jobbers, Dealers, write for quantity prices
GALENA CRYSTAL MFG. CO.
 464 Bushwick Ave. Brooklyn, N. Y.

We are manufacturers and distributors of
RYC
RADIO FREQUENCY TRANSFORMERS
 200 to 600 M. Wave Lengths.
RYC
CHOKE COILS
 0.1 and 0.01 Henry
RYC
RESISTANCES
 12,000 Ohms
RYC
 Products Are Guaranteed Products
LIBERAL DISCOUNTS TO DEALERS AND JOBBERS
YORK RADIO CO.
 1384 Bristol St., New York City

THE DEALER IMPORTANT

(Continued from page 34)

condition is unnatural and must be remedied. Every reputable dealer who is handling the equipment of representative manufacturers must let these manufacturers know that he is on the map. The radio dealer should see to it that he receives a plentiful supply of circulars, literature and display material. He should be able to obtain electrotypes from the manufacturer for his local newspaper advertising and he should tie in his advertising with that of the manufacturer.

Both the radio dealer and the radio manufacturer have recognized the fact that the jobber performs a useful and logical function just as in the older industries, such as the electrical industry. From the standpoint of the manufacturer the jobber acts as a balance wheel serving to keep demand on a more even basis and thus helping to minimize production costs. Moreover, the jobber, by carrying a certain amount of stock, adds his financial resources to those of the manufacturer, thus permitting of more flexible credit arrangements as far as the dealer is concerned. With the radio industry on a more settled and established basis the dealer will have the additional advantage of being able to obtain from the jobber whatever equipment he requires when he needs it and in small or large quantities. The dealer should see to it that his jobber does not compete with him as a retailer and that he is being allowed the discounts set by the manufacturer. Aside from this he should not look to the jobber to help his sales.

Although the radio dealer is probably buying from the jobber rather than direct from the manufacturer, he should make it a point to keep in very close touch with the latter. He should request window display material, catalogues, advertising literature and all other sales helps which the manufacturer may have. If he does not get prompt and willing co-operation he should transfer his trade to the manufacturer who is wide-awake enough to realize that the radio dealer, selling to the ultimate consumer, is the determining factor upon which the success of all depends.

DICTOGRAPH DIVIDEND

The Dictograph Products Corporation directors last week, declared a dividend of 8 per cent upon the cumulative preferred stock for the last quarter, payable September 15.

Variable Condenser—Tested and Guaranteed. Immediate Deliveries.

43 plate001	\$3.50
23 "0005	2.75
13 "0003	2.50
11 "00025	2.25
3 "	Vernier	1.25

Liberal Discounts to Dealers
DETROIT RADIO SUPPLY CO., MFRS.
 228 East Baltimore Detroit, Michigan

To Manufacturers and Distributors
A SPECIFIC GUARANTEE
 Backs **CONTAINA CRYSTAL** Setting
 (Patent Pending)
MAXIMUM SENSITIVE AREA AVAILABLE
 Awarded Evening Mail Certificate of Excellence
CURTIS G. CULIN
 366 Broadway New York City

MANUFACTURERS & JOBBERS

A MAILING LIST OF DEALERS to our Advertisers

The
RADIO RED BOOK
 CIRCULATION 25,000

radio trade directory & buyers' guide
 120 PAGES — PRICE \$1.00

write for rates

RADIO RED BOOK PUBLISHING CO.
 406 West 31st., NEW YORK CITY

New Couplers

Thompson-Levering Makes Odd Bank Wound Parts

Thompson-Levering Co., Inc., of Philadelphia, for years recognized as among the foremost manufacturers of electrical instruments, have designed a unique line of bank-wound vario-meters and vario-couplers for which they claim superiority over many of the types now widely in demand. These parts, as can be seen from the accompanying illustration, differ greatly in design from the average.

It is claimed by this company that the use of solid material for a surrounding medium does not give as good results as does air, because of the losses engendered by the



former medium. To this end their engineers have made the coils self-supporting, and the only solid material in the immediate vicinity are the small clips which enable the coils to rotate.

This type of coupler is said, therefore, to have losses less than those of other types, and an equal wavelength. They also have low distributed capacity, large inductance variation, and low comparative resistance.

Other products manufactured by this company for the radio trade are variable condensers, plugs, jacks, telephone head-sets, and a recently added line of choke-coils and non-inductive resistances for use in the new Armstrong super-regenerative circuit. All Thompson-Levering products bear the "Peerless" trademark.



Which Is The Best Radio Line?

Mr. Dealer—now is the time to make a careful comparison of the Radio lines offered you. Selection of the best line will enable you to lay a foundation for a permanent, profitable radio business.

Illustrating a few items of the Bestone Line

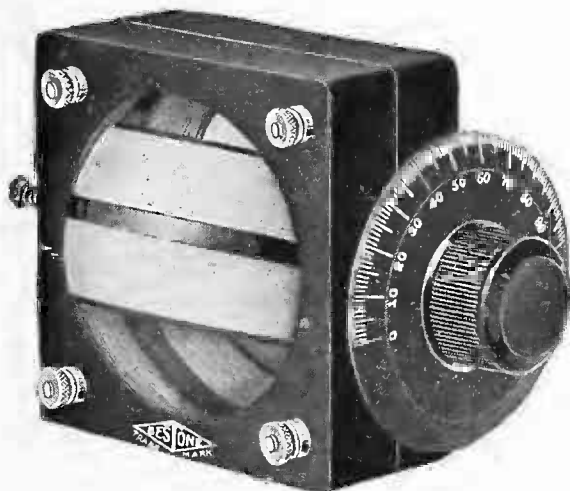

No. 711—"Bestone" Variometer

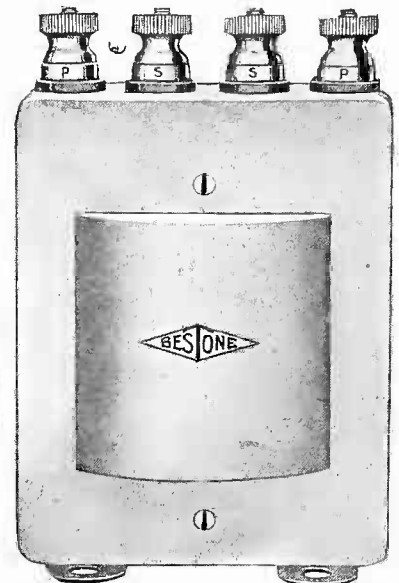

No. 715—"Bestone" Fully Enclosed Amplifying Transformer

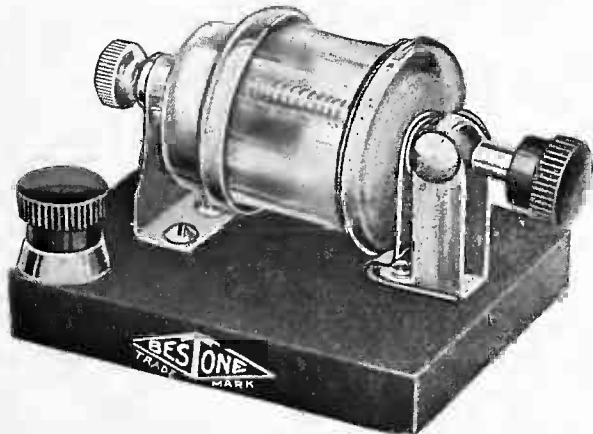

No. 716—"Bestone" Horizontal Crystal Detector



No. 723—"Bestone" 23 Plate Variable Condenser

INVESTIGATE

Bestone Wireless Apparatus

the high quality Radio line which you can sell with satisfaction and profit.

Write for Catalog and Discounts

HENRY HYMAN & CO., Inc.

Manufacturers

Chicago
212 W. Austin Ave.

New York
476 Broadway

San Francisco
711 Mission St.

Permanent Radio Fair

Announce Plans for Permanent Exhibit of Radio Equipment

Announcement has been made of a permanent radio fair, or exhibit, directed and managed by R. F. Yates, of The New York Evening Mail, to open September 1st.

The Red Room of The Hotel Imperial, New York City, has been secured for this exhibit, and a number of manufacturers are expected to reserve space where they may display their products.

The exhibition will continue until May, 1923, according to the preliminary announcement of the management.

The hall will be open to buyers only, during the morning hours, admission being by card only. An engineer will be in attendance, according to the announcement, who will demonstrate the equipment displayed. In the afternoon and evening hours the room will be open to the public.

Special facilities will be arranged for the distribution of literature for manufacturers exhibiting in this hall.

PHONETRON LOUD SPEAKER

Lieut. R. L. Adams of the Sound Wave Corporation, Brooklyn, N. Y., writing of the loud speaker manufactured by that company and which is known by the trade name of Phonetron says, "The loud speaker embodies an entirely different principle from that on which all other loud speakers operate. A large conical diaphragm propagates the full sound in all directions, and does not take a given amount of sound and 'shoot' it in one direction to concentrate it at that point. The result is a perfectly clear reproduction of the sound sent out, which is not distorted by sound interferences, nor by metallic vibrations within a horn." The construction of the Phonetron is simple and is not susceptible to damage by ordinary use. Another feature is that it does not require a current from the A battery to operate and therefore does not cause a heavy drain on that part of the radio set.

STRAHS MOVES

The Strahs Aluminum Company formerly of 53 Grand Street, New York City, announce their removal to much larger premises on September 1, 1922.

Their new location at 48 Franklin Street, New York City, is in the heart of the metal district.



Standard
2500 Ohm
Headset

Retails at \$5.75

Guaranteed to be equal to any phone on the market retailing at \$8.00

Polished aluminum shell—excellent of course
 Duranoid cap—strong and durable.
 Laminated magnets—maximum flux density.
 Enameled diaphragm—prevents corrosion.
 Adjustable pole pieces—no rattling as loud speaker.
 Perfect workmanship—backed by 15 years electrical instrument manufacturing experience.

JUDGE FOR YOURSELF
Dealers and Jobbers Write

THE MILLS RADIO & ELECTRIC CO.

Distributors for: STANDARD headset Irvington SPA- GHETTI KENTONE Amplifying Horn U. S. Variable Con- densers	Manufacturer of AER- WIN Products: Vernier Adjuster Variometer and Vari- coupler Model "A" Receiving Unit Special Detector Crystal
---	--

1010 Springfield Ave. Irvington, N. J.

WANTED—Your Confidence

OUR LINE OF APPARATUS

DIALS KNOBS JACKS PLUGS PANELS TUBING ROTORS STATORS "SPAGHETTI" INSULATORS METAL SOCKETS	MOULDED TUBE SOCKETS RHEOSTATS POTENTIOMETERS BATTERY SWITCHES BALANCED VARIABLE CONDENSERS CONDENSER END PLATES VARIO-COUPLER ASSY INDUCTANCE SWITCHES VERNIER DIAL ATTACH- MENTS
---	--

All our products are manufactured with the greatest care. Extensive and thorough experimental tests have been made on each part. All parts sold by us are guaranteed to be exactly as represented. Our slogan, "Apparatus built to build and hold a reputation," means to us much more than perfect design, workmanship and operation of our products. It means SERVICE of the highest quality that we render to our friends and patrons.

It will be our pleasure to submit catalog, discounts and laboratory tests on request.

BROUN RADIO COMPANY
 Manufacturers and Manufacturers' Representatives
 552 Seventh Avenue New York City

RADIO FREQUENCY RECEIVER

**TWO TUBE SUPER-SENSITIVE RECEIVER.—
 THE LATEST DEVELOPMENT IN A SIMPLY
 TUNED LONG DISTANCE RECEIVER. CAN BE
 USED DIRECTLY ON LOUD SPEAKER IF WITH-
 IN 50 MILES OF BROADCASTING STATION.
 UNLIMITED RANGE WITH AMPLIFIER. LOW-
 EST PRICED HIGH GRADE SUPER-SENSITIVE
 SET MADE; \$65.00. DEALERS WANTED.**

WIRELESS PHONE CORPORATION 193 ELLISON STREET
 PATERSON, N. J.

LET OUR FREE
SERVICE BUREAU
 Help You Buy Your Supplies

SEE PAGE EIGHTEEN

New York Show

Radio Exhibits to Be Feature at Electrical Show

With a large section of the main floor turned over to the manufacturers and dealers in radio apparatus, the wireless department of the New York Electrical and Industrial Exposition promises to be one of the most important and interesting of the entire show. The show is to be held October 7th-14th at the Grand Central Palace. The wireless displays will be grouped on the main floor and, as they will all include working demonstrations they will appeal not only to the fan who wants to see the latest developments in apparatus but to the novice.

Among the wireless companies which will exhibit this year, according to the management of the show, are the Radio Corporation of America, the Weston Electrical Instrument Co., the Continental Radio Corporation, the Pioneer Radio Co., Disbecker and Co., John Firth and Co., Electric Service Engineering Co., V. Himmer, Jr., Shelton Electric Co., Multiple Storage Battery Co., Electric Storage Battery Co., Sleeper Radio Co., and the Norman W. Henley Publishing Co.

WIRELESS ELECTRIC SETS

In a recent circular issued by the Wireless Electric Company of Pittsburgh is described a receiving set Type RA-4 having one step of radio frequency and two steps of audio frequency amplification. A feature of the set is that any combination of radio and audio frequency amplification may be obtained by the operating of a special switch on the panel. Type DC receiving set is a crystal detector unit consisting of a variocoupler tapped for continuous adjustment over its entire primary, a secondary condenser and crystal. A novel feature of this set is that it may later be used as a unit for an audion set and may be put into use as a crystal set at any time the tube set should not be working due to discharged batteries, etc.

GENERAL ELECTRIC

General Electric stock is now selling at around \$183, and it is hard to realize that only a year ago Wall Street was enthusiastically selling the stock short below \$110, and predicting a dividend cut and much lower prices still. There is nothing back of the present advance, except a high-grade, sure 12 per cent. stock taking its proper place in a rising investment market.

And now
the S-P-2 "ADAPTER"

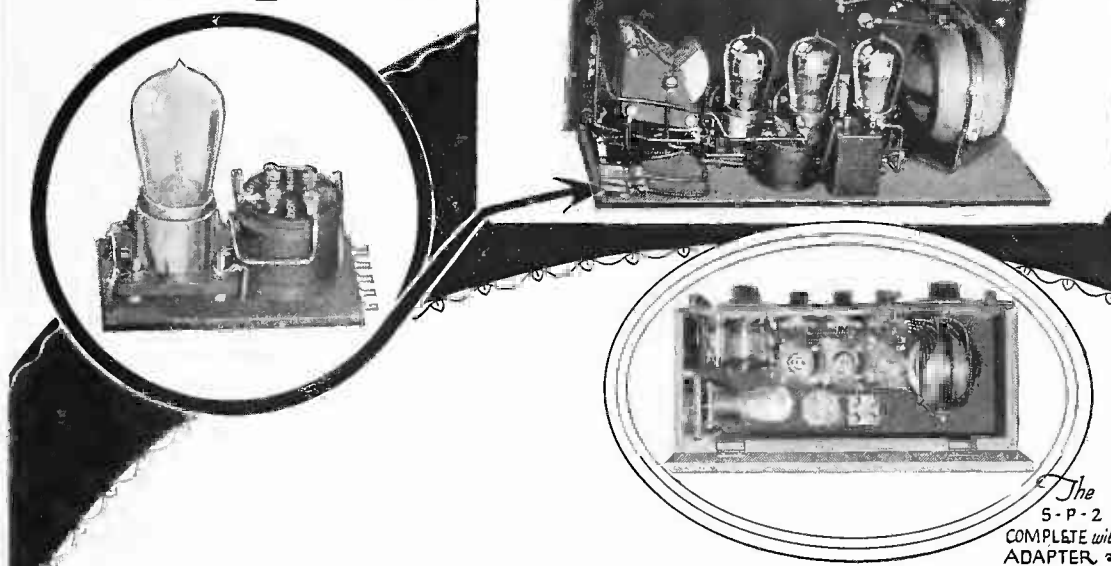

Another remarkable feature added to the amazing S-P-2 Receiver. An Adapter representing an additional stage of audiofrequency amplification, added to the S-P-2 Receiver AS SIMPLY AS INSERTING A TUBE INTO A SOCKET. Without necessitating the change of a single binding post, wire or batteries or headphones! The S-P-2 Adapter is a basic patent and is thoroughly covered.

The S-P-2 RECEIVER, now in vast production and under the severe test of hundreds of dealers everywhere, has thoroughly established its claim of ACTUAL SUPERIORITY as against any regenerative receiver now offered costing \$125 to \$180, based on actual comparisons. THE LIST PRICE OF THE S-P-2 IS BUT \$85, WITH AN ADDITIONAL CHARGE OF \$15 FOR THE ADAPTER.

The S-P-2 is a complete Receiver of radio-telephone and radio-telegraph signals over a wave length range of from 180 to 650 meters, using three tubes, viz.: detector, one stage of radio frequency amplification and one stage of audio frequency amplification.

The S-P-2 accomplishes the exit of the day of blatant and aggravating "noise" in radio reception. It brings the QUALITY in music and in all instrumental and vocal signal that is now universally desired and demanded. The great "evil" of radio (harsh and distressing foreign noises) has been wonderfully overcome in the amazing manner in which the S-P-2 PRACTICALLY ELIMINATES all atmospheric disturbances, commonly known as static, and also such interferences as received from local power stations, arcing commutators, street cars, rumbling traffic, etc.

The S-P-2 Receiver is also especially designed for the reception of long distance and weak signals. In thorough tests, using a single wire antenna 40 feet long and approximately 20 feet above ground, the entire broadcasting programs of Newark, N. J., Schenectady, N. Y., Atlanta, Ga., Detroit, Mich., Davenport, Iowa, Louisville, Ky., and Kansas City, were received nightly in Pittsburgh, Pa.—and during the mid-summer, supposedly poor receiving months. This reception was duplicated when using four wires strung along the ceiling of a one-story building. In the most severe tests, interference from static was not noticeable.

Dealers, write today for Catalog 101B

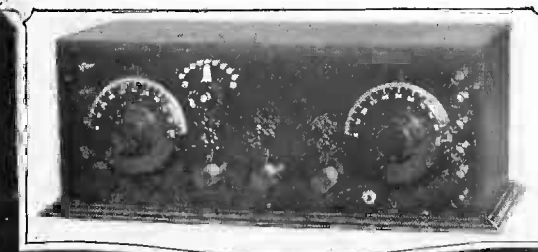

PITTSBURGH RADIO SUPPLY HOUSE

963 Liberty Ave. Pittsburgh, Pa.

BELL TELEPHONE
GRANT 3631

Du Kane
Variable Condensers
All Metal
High Capacity

43 }
23 } Plate Sizes
17 }
11 }

Immediate Shipment
Any Quantity

Duquesne Radio & Mfg. Co.
6426-28-30 Hamilton Ave.
PITTSBURGH, PA.



**THE BEST
HEAD SET
AS YET
LIST \$5.75**

Distributors—Jobbers
Dealers—Write

**STANDARD ELECTRIC
SALES CO.**
843 Broad Street
NEWARK, N. J.



\$100.00 will give you a complete stock of supplies to start a Radio department.

Write for full particulars.

When in the market for crystals, remember U. S. Eagle crystals are the best.

U. S. Radio Co. of Penna., Inc.
Manufacturer, Distributor and Importer
Corner Ferry and Diamond Sts.
Pittsburgh, Pa.

Broadcasting by Relay

Crystal Sets to Hear Long Distant Broadcasting Stations

Radio development to the nth degree is planned by Colonel E. H. R. Green, son of the late Hetty Green, for the new high-powered broadcasting station he is having built at Round Hills, South Dartmouth, in Southeastern Massachusetts. The new station, which will be in operation in September, will be heard only in the New England area, but some of the things Colonel Green plans are of interest to radio enthusiasts everywhere.

Through a system of relays Colonel Green purposes to transmit to the small crystal sets in New England homes messages from Scotland, Germany and ships at sea. Double use will be made of his station, which in equipment will be practically a duplicate of the best types of broadcasting stations.

"Everything that is broadcasted from other stations we will be able to pick up," said Colonel Green in outlining his plans recently. "And these we shall relay through our new station to the 'boys.' Our big amplifier will so broadcast the sound that concerts from stations such as Newark will be as clear through the small receiving sets of this vicinity as if the singer or player were in the same room. By the relay station we will overcome static electricity and render everything clear."

"Another feature," continued Mr. Green, "will be a station at Padanaram (a nearby summer resort), with a broadcasting radius of 5,000 feet. People for almost a mile around who can not afford receiving sets will hear the concerts. Persons on the boats in the harbor may hear them; also passengers on the New York boat as it passes within radius. If we have friends on the boat we will be able to talk to them easily."

The organization of a news service by radio is one of the things advanced by Colonel Green. "By private wire to New York," he says, "news will be received and broadcasted before it is printed. I believe that a radio association will come into existence something like the Associated Press.

"The radio may broadcast the fact, but it can not give the full details of a story. People hearing the radio report would buy a newspaper to learn more of the account. Radio in this respect would be much like a bulletin board."

Ask Our
Service Bureau
See Page 18

KRAMER RADIO COMPANY

4713 Sheridan Road. CHICAGO, ILL.
MIDWEST DISTRIBUTORS
Of Quality Radio Products

Write Us for Catalog and Discounts



Our Radio Department is conducted by electrical engineers which assures you with dependable and highly efficient Radio equipment, either in complete sets or separate units, such as Head Receivers, Varicouplers, Variometer, Cabinets, Detectors, Antennas, Rotary Spark Gaps, Sliders, Panels, Dials, Knobs, Condensers, Grid Leaks, Contacts, Galena Crystals, etc.

For a popular home receiving set we recommend the RESODON. This set comes in a beautiful mahogany finished cabinet. Write for literature.

PAUL G. NIEHOFF & CO., Inc.
Electrical Laboratories and Manufacturers
238 E. Ohio Street Chicago

GANAERITE Detector Crystals

Twenty years of practical mineralogy gave us the material to produce the highest quality crystal.

We are now undertaking the largest single order for mounted crystals in the market.

We individually test and guarantee to replace or refund on any unsatisfactory Ganaerite crystal.

The Harris Laboratory
26 Cortlandt St., New York City

A Song Well Sung

Parkin Advertises Good Times and Also Acts

By L. N. ALLEN

In a recent letter sent out to the trade the Parkin Manufacturing Company of San Rafael, California, strikes the key note of the tune that should be a best seller the year round. The popular song is named "Optimism" both in word and deed. The Parkin company have expressed the 'word' in its letter and the 'deed' has been carried through in the recent enlargement of the San Rafael factory and the running of three shifts in order to get a big stock to fill the fall demand. The company is preparing for what it tells the radio industry in its letter is to be "a bigger boom than ever will start in September." A line like that sent out by every one in the radio field to their respective correspondents would result in a boom that would make the 'klondike' a thing to be forgotten.

The Parkin company is also backing up its opinion with an advertising campaign, another way of saying "We'll bet we're right."

In its recent catalog the Parkin company also shows its keen regard for the "Purchaser." A careful reading of the few paragraphs addressed to that worthy personage will prove that the company was not a birth of the last few months and bears out the fact that it has profited by its years of experience in the radio field.

Among the products of the Parkin company is a new type of dial rheostat (patent pending) known as the Parkin Dial Type Rheostat that carries the resistance element in a groove in the back of a three inch molded bakelite dial, a construction that eliminates much material in construction and thereby lowers the cost. The Parkin Knob Type Rheostat (patented) is somewhat similar in principle of construction to the dial type. The resistance element is directly back of the knob, the variable resistance being made by a stationary spring brass contact. Another product is the Parkin variable condenser (patent pending) that employs the use of mercury, mica, bakelite and tin foil in its construction.

VARIABLE ANTENNA PLUG

Works Where Others Fail. Uses No Current.

Jobbers and Distributors

Write for Discounts

Made by

Levre Mfg. Co.

Manufacturers of Radio Insulite Products

Complete lines of INSULITE PRODUCTS

WM. J. MILLARD & CO. TILLMAN PRODUCTS

THORDARSON CUTTING & WASHINGTON U. S. TOOL CO., INC. ROOKER & BARRON UNIVERSAL "A" BATTERIES

Panels, Tested Condensers. Radio Frequency Transformers, List \$2.00.

Enclosed Detector, Rheostats, Potentiometers, Plugs, VT Sockets, Complete Receivers, etc.

Transformers Regenerative Receivers Variable Condensers Crystal Sets from \$5 to \$25 All Sizes

Also Jacks, Homerchargers, Dials, Coils, etc.

GENERAL MERCHANDISE COMPANY

of N. J., Inc.

NATIONAL DISTRIBUTORS

142 Market Street

Newark, N. J.



JUST LIKE A VARIABLE CONDENSER

Price \$1⁷⁵

ACTUAL SIZE Satisfaction Guaranteed

HAVE YOU HEARD? OF THIS PROPOSITION?

IT SELLS ON SIGHT

GEN. GEO. O. SQUIER

has Edited Seven Popular Books on Radio, Prepared by Prof. Morecroft of Columbia University, R. S. Ould of Bureau of Standards, John V. L. Hogan, Raymond F. Yates, Waldemar Kaempffert, Pierre Boucheron and A. P. Morrison, known as

THE EASY COURSE IN HOME RADIO

SEVEN VOLUMES—560 PAGES
150 FULL PAGE ILLUSTRATIONS

EACH VOLUME HAS AN
ATTRACTIVE COLORED COVER

We Back You With
NATIONAL ADVERTISING
ATTRACTIVE CIRCULARS
ARTISTIC POSTERS

1. A Guide for Listeners-In
2. Radio Simply Explained
3. Tuning and What it Means
4. The Alladin's Lamp of Radio
5. Bringing the Music to the Ear
6. How to Make Your Own Parts
7. Installing the Home Set

Seven volumes including
an artistic box container

List Price, \$3.00 per Set
50c per single volume

ASK YOUR JOBBER
TO SHOW THEM TO YOU

OR WRITE US FOR A
LIBERAL PROPOSITION

MARTIN H. RAY
Publisher

165 BROADWAY, NEW YORK

Mu-rad Receivers are Very Efficient

There is a peculiar and indisputable fascination in being able to hear signals 500 or a thousand miles away, so that one can, by making a single simple adjustment, bring in various stations from widely different parts of the country, and if, moreover, this can be done without the necessity of erecting an outdoor aerial wire, the average modern radio enthusiast may rightly consider that he is enjoying the possibilities of radio reception.

In the efforts of the Mu-rad Laboratories, Inc., to produce a receiver for the latest group of radio enthusiasts it has developed a class of receivers with the deliberate idea of producing equipment of fine sensitiveness, which will meet the most exacting demands not only of the amateur relay man but also of men in all walks of life who desire the very finest results. Two types of receivers have been constructed: the Type MA-12 three stage radio frequency amplifier and detector unit, and the Type MA-13 three stage radio frequency amplifier, detector and two stage audio frequency amplifier. Each is a continuous range receiver, from 175 to 600 meters. Tuning is accomplished by a single unit, a variable condenser, connected across the input terminals of the set.

This sensitiveness is obtained by patent circuits and transformers employed in the three stage radio frequency amplifier portions of the sets. Both receivers have a conservative range at all seasons of the year of 300 miles from broadcasting stations, using a small 4-inch diameter coil as "pick-up" without any aerial whatever. They may be used with a larger loop if greater range

is desired or with an antenna for extreme distances of the order of 1,500 miles or greater. With a 1 ft. square loop, the Type MA-13 will bring in music and reports from broadcasting radiophone stations of the usual type several hundred miles distant with sufficient intensity to operate a loud speaker so that the signals are intelligible throughout a large room or hall.

In construction, these receivers follow the highest engineering standards. Special metal adjustment dials are used which are grounded to prevent external capacity effects. One dial is provided for tuning, while a second dial controls a patent circuit unit useful for stabilizing the receiver and controlling the strength of the received signals. Rigid wiring results from the use of tinned copper bus wire. The cabinets are of solid mahogany, varnished, and given a piano finish. The panels are of polished black Radion. All metal parts within the cabinets have a white satin-nickel finish.

NOVEL TYPE CATALOG

The Radio Development Corporation of Springfield, Mass., has hit upon the idea of combining an interesting magazine and catalog. The magazine is known as the "Radio Development" and is issued monthly. The topics covered are of general interest to the consumer and cover the construction of sets that have been made by the company and found satisfactory. The write-up on the different sets gives a short description together with a list of the various parts necessary for construction and the list price of the parts, while the hook-ups are well illustrated.

Factory
of the
Murad
Laboratories,
Asbury Park,
New Jersey



New Company

Announce Combination of Radio Interests

A consolidation of a number of distributing and manufacturing interests under the title of the Fourar Radio, Inc., has been brought about, according to a recent notice sent out by the corporation, its purpose being to act as distributors to department stores of radio merchandise qualified to meet the requirements defined by a representative body. The officers of this corporation are well known to the radio field. Alfred Fantl, head of the Fantl buying organization, is president. William Dubilier, president of the Dubilier Condenser and Radio Corporation, is first vice president. The second vice president is Frederick Dietrich, president of Brandes, Inc. Third vice president is Maurice C. Rypinski, formerly sales manager of the Westinghouse Electric and Manufacturing Company. Secretary and treasurer is Arthur Wiesenberger, formerly director of research of the National Dry Goods Association.

In announcing the incorporation of Fourar Radio, President Fantl summed up the purpose of the corporation as follows:

"Notwithstanding all that was accomplished (in radio)—and much indeed was achieved in the struggle towards standardization and dependability—there remained the factor of finding merchandise of the quality required in volume adequate to supply the enormous national market. And not for department stores alone, because, while the department store does represent the ideal in such high class retailing, there will always be other retail outlets making appeal to the consumer and endeavoring to qualify for radio in its best estate. It was the office of commerce to supply this link missing from distribution of radio. It is the aim of Fourar Radio, Inc., to serve as the needed link. It has been organized to serve as the responsible merchandising organization in the wholesale field, with its direction including only men who are either expert as radio engineers or as merchandisers.

"They will endeavor to maintain a standard which will render service completely satisfactory to the public; to sell at prices which will enable manufacturers to guarantee deliveries to provide a discount for the retailer that will permit of profitable merchandising; and to remove the complications now besetting the sale of radio so effectively that its sale to the public shall be established on a sound, profitable basis."

ESTABLISHED 1888



SENSORY CABINET UNITS

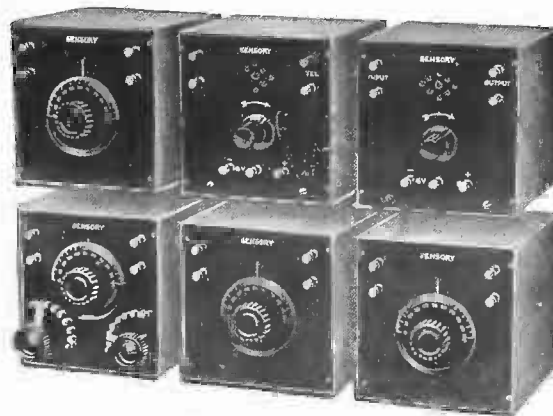

The most flexible method of adding to, or obtaining a variety of hook-ups, and giving an appearance equal to any single cabinet set. Each cabinet contains a "Sensory" element.

THE FULL LINE OF "SENSORY" ACCESSORIES IS SHOWN IN OUR NEW BULLETIN NO. 12
WRITE FOR IT TODAY

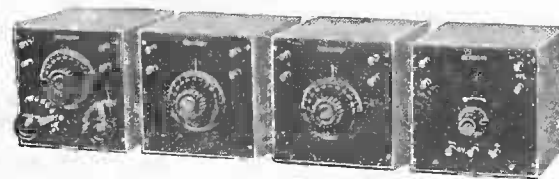

HEINEMANN ELECTRIC COMPANY

Manufacturers

Radio Division

Philadelphia, Pa.

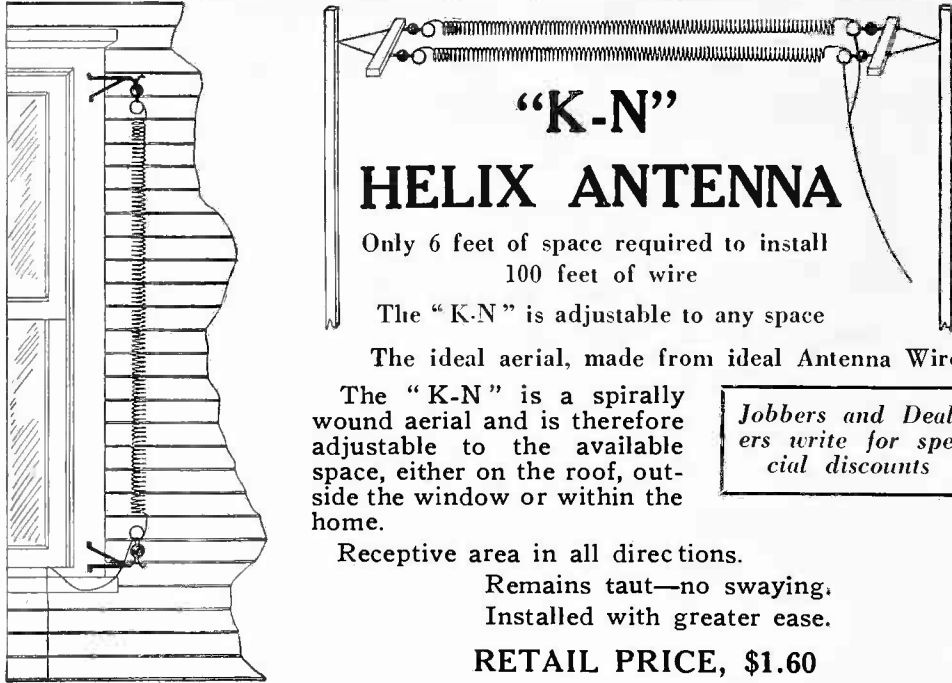

**“K-N”
HELIX ANTENNA**

Only 6 feet of space required to install
100 feet of wire

The “K-N” is adjustable to any space

The ideal aerial, made from ideal Antenna Wire

The “K-N” is a spirally wound aerial and is therefore adjustable to the available space, either on the roof, outside the window or within the home.

Jobbers and Dealers write for special discounts

Receptive area in all directions.
Remains taut—no swaying.
Installed with greater ease.

RETAIL PRICE, \$1.60

Manufactured by
WALTER S. KRENZ

339 So. Central Park Blvd. CHICAGO, ILL.

Forms for the
OCTOBER ISSUE OF THE RADIO DEALER
Close. at New York, September 15th. Advertisers desiring proofs should have copy in considerably earlier
ADVERTISING DEPT., THE RADIO DEALER
1133 Broadway, New York, N. Y.



\$3.75

MADE IN NEWARK N.J.

Rad'O Crystal Attachment

For Your Crystal Set Use One Ear Phone, a RAD'O and the Whole Family Can Listen In

Made of Aluminum—and designed according to the laws of acoustics, and guaranteed to give satisfaction. Tubes of best quality rubber, with heavy walls; the ear tubes made of hard rubber and easily kept in sanitary condition. By the use of the Rad'O all distortion is eliminated.

Jobbers Communicate **RAD'O, P. O. BOX 418, NEWARK, N. J.** Dealers Ask Your Jobber

Offering Varied Parts

Jobbers Are to Feature Many Stellar Radio Parts

By **FREDERICK W. GERMER**
Mgr. General Merchandise Co.

After a great deal of experimentation, the Levre Manufacturing Company, of Newark, N. J., manufacturers of Radio Insu-Lite Products have perfected an Antenna Plug that will work under all conditions. This plug, when directions are closely followed, operates in the same manner as would a variable condenser connected in series with the lighting circuit. The secret of their success lies in the manner in which the four condensers used in this plug are constructed. There has already been a large demand for their products. It is only natural that this plug wherever purchased, will establish the name of the Radio Insu-Lite Products with every radio fan who uses it. They also manufacture condensers which are built and tested by hand, and are sold with the guarantee to test within one micro-farad.

These condensers are built in all capacities and only the radio fan who builds his own tube or crystal set or his favorite Armstrong hook-up can appreciate the value of a fixed condenser to test within one micro-farad of its capacity. The writer has been informed that the Levre Manufacturing Company is to install a Weston machine for testing these condensers as it will facilitate their production to such an extent as will supply the demands of the general market.

Another item which has met with popular approval is the Insu-Lite panel. The cost is approximately one-half that of any reliable panel, and is claimed to be the very best attainable in radio panels.

In the next issue of this magazine, there will be advertised the latest creation of the engineering staff of the Levre Manufacturing Company, to wit: a radio frequency transformer which in the mind of a number of experts is really something that has long been looked for by the radio amateur. The cost will be approximately one-half that of the cheapest makes now on the market, and the service rendered will be as good if not better than the most expensive. It is very small and compact in size. Deliveries can be made promptly.

The General Merchandise Company of New Jersey, Inc., offices at 142

Market Street, Newark, N. J., have been appointed general distributors for the products of the Levre Manufacturing Company and can promise immediate deliveries on all products of their manufacture.

The General Merchandise Company is also distributor for William J. Millard & Company, manufacturers of the well-known Tillman Products. Also distributor for Thordarson Transformer Company; Cutting and Washington Corporation, manufacturers of Regenerative Receivers; Rooker and Barron Manufacturing Company, manufacturers of regenerative and non-regenerative sets, and also a complete line of crystal receiving apparatus; Essex Radio Manufacturing Company, manufacturers of the Erasinc VT Receivers and numerous other well liked radio parts and accessories.

TITAN-O-TONE CRYSTAL SET

According to the T-F Radiophone Company of Brooklyn, N. Y., manufacturers of the Titan-O-Tone, the purpose of this set is to permit every one, even those of small means to enjoy the benefits of broadcasted news and music. Due to the novel features of construction the set eliminates foreign noises to a great extent. Its parts are well made with the purpose in mind of making a product that will be permanent. The company claims an average reception of 35 miles with the Titan-O-Phone. The T-F Radiophone Company also announces large sales of its "Crystal Wash," a preparation for cleaning the surfaces of crystals, one of the novelties of the year.

PREMIER RADIOVOICE SET

The Premier Radio Corporation of Detroit is placing a new detector and two stage amplifier known as the Premier Radiovoice, on the market, enclosed in an attractive plywood cabinet. A special hook-up used in this set incorporates a triple unit pancake coil with tapes taken off to cover a range of wave lengths from 150 to 600 meters. It is claimed that this type of winding is highly efficient, as it eliminates all possibility of the incoming signal strength being consumed or dissipated within a number of complex windings. The control, aside from the rheostats regulating the lamp filaments, is incorporated in two lower knobs, one for setting the pancake inductance to the proper wave length, and the other utilizing the condenser for tuning to the proper degree of sharpness and clearness. For long distance reception and tuning a jack is placed in the center of the panel to permit plugging in head phones.

RADIO HOMCHARGER DE LUXE

Beauty has been combined with utility in the new Radio Homcharger de Luxe, a battery charging rectifier developed by the Automatic Electrical Devices Company, 144 West Third Street, Cincinnati, Ohio, especially for the Homcharging of Radio A and B batteries.

Finished in a dull mahogany and beautiful old gold, it harmonizes with the finest room furnishings, and permits the radio enthusiast to recharge his battery after an evening's entertainment, without even disconnecting it from his set.

The Radio Homcharger de Luxe is constructed upon the same perfect operating principle used in the Type A Homcharger, which has heretofore been the most popular battery charging rectifier in the radio field. Its working parts are entirely enclosed, eliminating all danger of shock and fire. It is constructed of the highest grade materials throughout—moulded bakelite base—jewel ammeter—oversized silicon steel transformer. There are no frail castings to break, as all parts are made from highest quality stampings.

The Homcharger de Luxe can be operated by anyone. It is self-polarizing, so that the batteries may be connected either way and they will always charge. It gives a tapering charge, as recommended by battery manufacturers, and is guaranteed not to harm or injure the battery in any way.

It is claimed to fully charge any A or B storage battery overnight at a cost of only a few cents. Conforms to the latest Underwriters' requirements and requires no watching.

The company has issued a very handsome booklet, illustrating the radio Homcharger de Luxe in actual colors.

THE EDISON ANNIVERSARY

Announcement has been made of the preparation of plans for honoring Thomas A. Edison and celebrating the fortieth anniversary of the beginning of the central service in New York. It was in September, 1882, that the current was first turned on. Edison himself planned the station. The celebration will take place in the form of an anniversary dinner to be held at the Hotel Commodore with Thomas Edison as guest. Sharing the honors with him will be the Edison Pioneers who worked with him on the first station. An extensive historical exhibit of the early electrical apparatus used at the first central station is planned for the Electrical Show to be held at the Grand Central Palace in October.

GERMAN RADIO APPARATUS INDUSTRY

Vice-Consul Nathaniel B. Davis,
Berlin.

German manufacturers of radio apparatus and equipment are not in a position to make extensive deliveries of their product, as up to the present time the demand has not been sufficient to warrant the manufacture of radio instruments in large quantities.

Amateur radio work is not popular in Germany, and stations are not numerous. Radio telephony in particular is almost an unknown science, except to engineers, professional operators, and experimenters. The principal reasons given for the lack of interest in radio on the part of the general public are that amateur stations are a luxury beyond the means of the average German under present economic conditions and are subject to official restrictions on their use.

All radio communication in Germany is under the control of the Federal Post Office Department, which operates the commercial stations. Private installations must ordinarily be made by the department; however, in exceptional cases private companies or individuals may be authorized to erect their own plants, but they must first obtain a license from the Post Office Department. The fee for such a license varies according to the size of the plant, with a maximum of 2,000 marks per annum.

At present only one station in Berlin is licensed to broadcast, the Deutscher Wirtschaftsdienst, which broadcasts market and exchange quotations. Subscribers to this service are permitted to install receiving stations upon payment of the license fee and the monthly subscription rates, which vary at present from 1,000 marks to 7,500 marks, according to the class of subscription. Subscribers may rent receiving sets from the Post Office Department for 2,500 marks per month, if they do not desire to build their own.

A similar service for broadcasting news items is being planned, but has not yet been put into operation. The organizers of this service, however, intend to serve provincial newspapers rather than amateurs.

In spite of the lack of demand for short-wave amateur apparatus, there are a number of firms in and about Berlin which manufacture either complete receiving sets or parts. Vacuum tubes are almost unavailable, and practically all receiving sets manufactured in this district operate with crystal detectors.

Vict-ra-phone Console Cabinets for Radio Sets

High Grade Cabinet Work Adds Neat Touch of Distinction of Quality Radio-Phonograph Sets

By THOMAS J. RYAN

Victor, Vict-ra-phone radio receiving sets, manufactured by the Victor Radio Corporation of New York, are built in period cabinets and console tables in several finishes and woods, being designed with the idea of presenting a high grade set as an article of furniture that would be added grace to any home.

According to the manufacturers there are a number of special features used in connection with their sets that make them especially adapted for the reception of music and voice, etc.

The designers of the Victor Corporation, according to recent announcement, are men of long years of experience in the manufacture of high grade radio apparatus, having been connected with the manufacturer of equipment for the army and navy for a number of years.

The tuning arrangement which responds to a wavelength range of 150 to 3,000 meters, consists of an antenna series condenser, a variometer and a triple bank Litz coil wound on formica tubing.

The detector and two stage amplifier are equipped with automatic filament control jacks, which not only provide a rapid means of shifting the telephones from one stage to another, but also increase the life of the vacuum tubes and storage batteries, as only the tubes actually in use are lighted.

The number of controls has been reduced to a minimum, so that operation is as simple as possible, without sacrificing close tuning. A copper shield is secured to the rear of the panel to keep the receiver free from external capacity effects.

The panel which is made of the best quality Bakelite Grade XX, is carefully machined and grain finished. The controls, telephone jacks, rheostats, etc., are neatly marked by engraving, filled in with white enamel.

In each of the different types, the

receiving set is located so as to be easily operated. The storage battery is placed in a special compartment lined with sheet lead, to protect the cabinet from acid and fumes. Batteries are also placed in a suitable compartment. In a set recently inspected all the wiring was quite neatly done and entirely out of sight.

The cabinets are ruggedly con-



Vict-ra-phone Console Cabinet for Phonograph and Radio Set Combined, Permitting Use of One Horn

structed of mahogany, walnut and oak, and are supplied in various finishes. A number of standard period designs are also furnished to the trade.

Antenna and ground connections are made to binding post underneath the cabinet, and are therefore out of sight. An antenna plug which may be inserted in any electric light socket is furnished with each set, so that an outside antenna is not required.

In addition to the console and period table types, the Vict-ra-phone sets are made up in upright style, designed after the fashion of upright phonograph cabinets, the set being placed in the top while the space below is reserved for batteries, etc.

In the combination radio and phonograph console type set, as pictured in connection with this article, one compartment contains the radio receiving set, while the other side contains the phonograph. The loud

speaker horn in the center can be used either for radio or for ordinary "canned music." These cabinets are supplied to the trade for sale either with or without phonographs, a sale oftentimes being made where the purchaser already has a phonograph that can be inserted in the set.

All parts used in these sets are of standard manufacture, considerable testing being done before every contract was placed. All incoming merchandise is severely tested as well as given other tests when the sets are assembled.

Connecting wires are covered with spaghetti and all joints and terminals carefully soldered. Metal parts are nickel plated to prevent corrosion.

GOULD CATALOG

The recent radio battery catalog issued by the Gould Storage Battery Company of New York covers briefly and completely the Gould radio A and B batteries. Other than a description of the batteries the catalog includes a table that permits

the purchaser to choose a battery suitable to his individual need. Another table shows the discharge hours of the various type batteries.

CRAMER CIRCULAR

The W. R. Cramer Company of Omaha, Nebraska, feel justly proud of their new circular containing a short story of the Cramer receiving set. An interesting and attractive cut shows, pictorially, the many good things that are going through the air that may be brought into the home by the Cramer receiving set.

DEALER AD.

The recent issue of the Tourist Directory of Henry, Ill., blazons forth the advertisement of a progressive radio dealer of that town. The Wicker Battery and Service Station has chosen a very suitable display of its sets and parts.

Planet Loud Speaker

It is generally conceded that to date the radio industry has not perfected the loud speaker without amplification by use of batteries. With the sudden demand for such an instrument during last spring those who were in the business for the sole purpose of getting money out of the market without giving the public a fair deal and the public glad to get anything that would intensify the noise bought anything that looked like a horn. These same "get-rich-quick overnights" evidently found a number of horns long discarded by phonograph manufacturers with the result that once more we gazed upon the crude horns that graced the phonograph in its earliest days. The result was a great deal of dissatisfaction with results.

The loud speaker of to-day is sold in a buyers' market with the result that attention is being given to clearness and quality of tone and not intensity of noise. There have been a few good loud speakers on the market from the start but they are indeed few. It is in this march of progress that the Planet Radio Company of Chicago files in placing on the market its new Planet Loud Speaker. Made of the best grade of materials including special patented Murphy bell alloy this loud speaker is claimed to be free from all distortion, scraping noises and static thus assuring clear tones and perfect sound reproduction. The speaker itself is attractive in appearance. The case is finished in mahogany, the emitter burnished and the connecting cord silk covered. The Planet speaker can be attached to any standard two stage amplifier receiving set, according to the makers.

MIRACO RADIO FREQUENCY

The Midwest Radio Company of Cincinnati, Ohio, are placing on the market a radio frequency receiver designed to meet the demand for a moderately priced, long distance, vacuum tube receiving outfit. It is reported by the company that broadcasting stations located in Georgia, New York and Missouri have been heard from Cincinnati and that under average conditions reception may be had at a distance of 300 miles. The set is simple to operate and may be connected with a loud speaker and an audio frequency amplifying unit. The company especially recommends the Miraco two step amplifier for most efficient results with the above receiver.

Jobbers! Dealers!—Guaranteed Long Distance Reception with "ETHERTROLA"

WRITE FOR OUR INTERESTING PROPOSITION, WITH "ETHERTROLA" YOU CAN BE ASSURED OF CONSISTENT 500 MILE RECEPTION

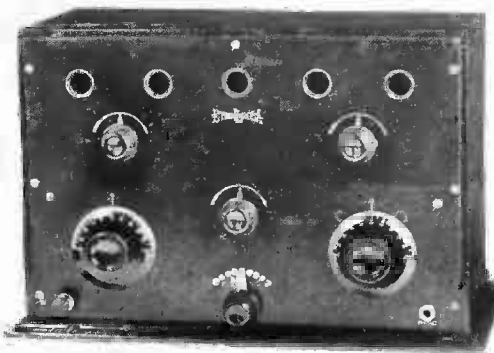

Type 2D2

On July 22 to 24 Havana, Cuba "Ethertrola" received KDKA and WJZ—a maximum distance of 1350 miles despite static disturbances.

At Babylon, L. I., every day "Ethertrola" receives WGY and WWJ a maximum of 750 miles, and many other long distance records.

For Loop or Antenna—2 Stage Radio Frequency, Detector and 2 Stage Audio Frequency Amplification

DOUBLELL RADIO CO.

57 Dey St.

New York City

INTERESTED IN RADIO PATENTS?

Radio Business men and Manufacturers who are interested in the patents issued by the U. S. Patent office may find this information each week in

THE RADIO DEALER WEEKLY

One dollar the year. Sample free on request

Address

THE RADIO DEALER WEEKLY, 1133 Broadway, New York, N. Y.

DEALERS AND JOBBERS

Our new Fall Catalogue No. 25 is ready, consisting of new featured Sets and Accessories. Our prices are right. Send for catalogue.

Manufacturers and Distributors of

Condensers
Vacuum Tube Sockets
Mountings
Dials
Rheostats
Potentiometers
Plugs
Jacks

Tube Sets
Crystal Sets
Knock-Down Sets
Headphones
Radio Frequency Transformers
Audio Frequency Transformers
Switch Levers
Binding Posts

DISTRIBUTORS WANTED



78 Fifth Avenue

New York

Variable Condensers of Quality

Designed by J. B. Elenschneider, for over ten years Engineer for the Marconi Wireless Telegraph Co. of America.

Embody features found only in instruments for commercial and professional use.

Some manufacturers of high grade regenerative receivers have adopted our condenser for their sets.

The condensers are constructed of the highest grade material and with best workmanship.

Insulating ends of high dielectric strength.

Plates of fine hard aluminum, shaped so as to give a straight line increase of wave length and minimum capacity when the condenser is in its open position.

Shafts, spacers, rods and nuts, and so forth, turned to precision—not stamped.

Bronze bearings with adjustment.

Each condenser fully guaranteed.

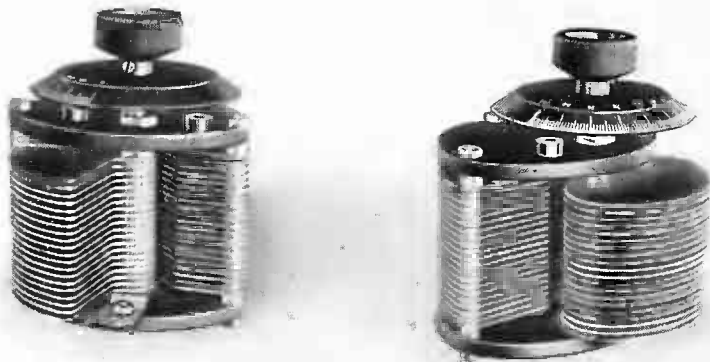

9 plates,
list price..\$3.25
21 plates,
list price.. 4.75
41 plates,
list price.. 5.75
Knobs or dials
extra.

THE FINEST CONDENSER MADE TODAY

Manufacturers, jobbers, dealers, write for discount.
Can make prompt deliveries.

Radio Laboratories of New Jersey, Inc., Cranford, N. J.

Book Review

By BERNARD JEROME FARRELL

The Editors of the RADIO DEALER will be glad to review new publications in this field as they may be issued. Address them attention BOOK REVIEW EDITOR, the RADIO DEALER, 1133 Broadway, New York City.

THE EASY COURSE IN HOME RADIO. Published by Martin H. Ray and Review of Reviews Co., New York City. Maj. Gen. G. O. Squier, Editor-in-Chief.

The course consists of seven volumes and has been planned to take the novice, in easy stages through radio reception in its important phases. Each volume is of such a size that it may be carried conveniently in the pocket and each deals with a particular phase of radio.

Volume one, 122 pages, "A Guide for Listeners In," by A. Morrison. This volume gives a description of several sets, explains how they are kept in good condition, how they are operated and answers the most obvious questions. In addition, the volume summarizes the Government and fire underwriters regulations, explains the meaning of radio terms, translates telegraph signals, gives a complete list of broadcasting stations with their call letters and concludes with a "who's who in radio."

Volume two, "Radio Simply Explained," by Waldemar Kaempffert. This volume lays down the principles of radio. It assumes nothing in the way of knowledge on the part of the reader and covers the subject to a nicety.

Volume three, 77 pages, "Tuning and What It Means," by John V. L. Hogan. This volume explains the whole process of tuning in terms of such familiar objects as tuning forks and pendulums.

Volume four, 77 pages, "The Aladdin's Lamp of Radio," by Prof. J. H. Morecroft. The subject of the vacuum tube is thoroughly and simply covered. It not only explains the action of the tube, but shows, with the aid of diagrams, the different ways in which the tube may be incorporated in circuits to produce different results. This is valuable to the man who owns a vacuum tube set and who does not understand clearly the functions of the vacuum tube, or who is building a vacuum tube set of his own.

Volume five, 82 pages, "Bringing the Music to the Ear," by R. S. Ould. This volume tells how the radio set

Can You Beat These Prices?

Federal Phones, 2200 Ohms....	\$8.00	List less 35% discount
Federal Plugs.....	1.75	List less 45% discount
Federal Jacks, All Numbers....	1.75	List less 35% discount
Federal Transformers.....	7.00	List less 35% discount
Dictagraph Phones, 3000 Ohms.	2.00	List less 35% discount
Glass Enclosed Crystal Detector.	2.50	List less 40% discount
Porcelain Rheostats.....	1.20	List less 55% discount
Potentiometers	1.75	List less 45% discount
Rheostats Composition.....	1.00	List less 50% discount
Phone Condensers (All Capacities).....	70 Cents	Net

Similar discounts on all your radio needs
Immediate deliveries

Frank Radio Co.

122 Fifth Ave.,

New York

receives not the human voice, but waves of electricity. It explains how the living voice is changed into inaudible electric waves, shows what happens when the waves strike the antenna and reach the receiving set, and reveals the process by which the waves are reconverted into sound.

Volume six, 59 pages, "How to Make Your Own Parts," by Raymond Francis Yates. This volume shows how the parts of a radio set can be built at home with nothing but the ordinary tools to be found in the average house.

Volume seven, 75 pages, "Installing the Home Set," by Pierre Boucheron. This volume is practically a continuation of Volume 6, its primary purpose being the explanation of the processes of installation. It discusses not just one set but all types of sets, from the simplest crystal detector to the elaborate set which dispenses with antennae altogether.

Over one hundred carefully selected pictures illustrate the seven volumes. In addition, there are fully one hundred drawings and diagrams.

"The Easy Course in Home Radio" is enclosed in an attractive box so that the volumes can easily be kept intact on the shelves of the library and yet used separately.

HOW TO MAKE THE VACUUM TUBE RECEIVING SET. L. D. Brigham. Published by the Archway Book Store, Seattle, Wash.

The purpose of this book is to give the amateur the information necessary to construct his own set and to do this in the clearest and most complete manner possible, according to the authors introduction. The purpose has been well carried through and the reader should find it a valuable guide in the making of a tube set. The hookups shown throughout the book are exceptionally clear and, thereby, relieve the text matter of the duty of many details that would otherwise be necessary. Each set described is shown hooked up and the parts used are listed conveniently together with the list of tools that good workmanship warrant using. A design of panel is shown for each of the various sets. The sets described and illustrated are a detector set, a two-stage amplifier set, a radio amplifier set, a radio-audio amplifier set, an Armstrong Regenerative set and the last named with amplifiers. The latter part of the book deals with various types of aerials, concluding with a number of valuable hints regarding receiving sets as a whole. In the back of the book is a list of the broadcasting stations and with their allotted wave lengths.

HOW TO BUILD YOUR OWN RADIO SET. By James R. Cameron. Published by the Technical Book Company, New York City.

The book is pocket size and contains much valuable information for those who contemplate building their own tube or crystal set. The first chapters are devoted to aerials, condensers, couplers, etc., covering their construction in detail. The latter half of the book is devoted to the installation of the set. In the back of the book is information regarding time signals sent out from the various government stations, a list of the popular broadcasting stations, the wireless alphabet, symbols used in radio work and a list of the abbreviations used in radio communication.

RADIO DICTIONARY. Published by the Technical Book Company, New York City.

Over seven hundred terms used in radio are defined and the relation of the various parts clearly explained. Numerous tables and charts of general aid to the progressive amateur fill the back of the dictionary. It is a unique handbook that fills a timely need.

THE BOOK OF WIRELESS TELEGRAPH AND TELEPHONE. By A. Frederick Collins. Published by D. Appleton and Company, New York City.

The Book of Wireless covers the field with earnestness, and does not try to do so in a few odd pages, but utilizes a full quota of over 200 pages.

The book is divided into three parts. Part 1 deals with a demonstration wireless outfit for sending and receiving, including a chapter on how wireless works and a method for learning the code. Part 2 covers the transmitter and receiver for long distances, the construction of appropriate aerials and a chapter on tuning the transmitting and receiving sets. Part 3 explains the latest phase of wireless telegraphy and telephony, namely, continuous wave transmission. Chapters are devoted to vacuum tube sets for both sending and receiving and an explanation of how the sets operate. The latter part contains useful information regarding Government rules and regulations and a definition of radio terms used throughout the book.

The book as a whole covers the radio field in plain and simple language and where further clearness warrants it, many drawings are used that need no code of symbols to explain.

RADIO FLASH. Published by Hubbs Publishing Company, Inc., New York City.

This booklet contains a collection of clear and self-explanatory diagrams of aerial and ground equipment and for receiving sets varying from a simple cigar box crystal outfit to a detector and two stage amplifier. Pictorial views of the various receiving sets and schematic wiring diagrams for them are clearly shown. The appendix contains information on methods of mastering the wireless code and a list of correct symbols used in diagrams and drawings. The book should prove useful to the beginner and those who are interested in constructing their own sets.

RADIO RED BOOK. Published by the Radio Red Book Publishing Company, New York City.

The Radio Red Book is published monthly and contains a compilation of manufacturers and distributors of radio apparatus under two main classifications. The first section is devoted to a directory which contains alphabetically arranged headings of radio products and beneath the various headings are listed the names of the manufacturers. The second section contains a directory of the trade names of the manufacturers of radio parts. This book is invaluable to the dealer who carries radio parts and should prove a means of securing many parts that otherwise he would be unable to obtain.

HOW TO MAKE YOUR OWN WIRELESS RECEIVING SET. By L. D. Brigham. Published by the Archway Book Store, Seattle, Washington.

This book contains complete instructions on the construction of a complete crystal receiving set consisting of a two slide tuning coil, a crystal detector, and fixed condenser, with a chapter devoted to the aerial and its installation. The set is claimed to be capable of receiving broadcasting or other messages within a radius of ten miles. The book contains diagrams that are easily followed. The book is of the type that should prove a good medium for dealers' local advertising. The publishers have printed a few lines informing the reader where he may buy the necessary parts to build the crystal set, and have reserved space for the dealer's name and address. The book sells for twenty-five cents.

Books for Review should be addressed, Book Review Editor, THE RADIO DEALER.

Marconi says:

THIS country is far in advance of any other in the radio development—so does NYCO; we ought to know, because we are supplying dealers and amateurs throughout the country with the best standard equipment.

A complete set—or any part of it!

"Write for our latest price booklet"

Radio



Supplies

507 PENWOOD AVENUE

WILKINSBURG, PA.

MILLIKEN CATALOG

The Milliken Brothers Manufacturing Company of New York City have recently issued a new and attractive catalog devoted to radio antennae towers.

Many new manufacturers in the radio field have placed on the Dealers' counters poorly printed and unattractive booklets and catalogs. It remained for the old timers to give the trade such attractive and artistic catalogs as that of Milliken Brothers. Having been in the bridge and building construction line since 1857 the company is in a position to show the radio industry something in the get-up of catalogs.

The catalog is a short treatise on the proper type of aerial and tower to use for specific cases. It is replete with photographs of towers the company has already constructed, and detail drawings of towers for various spans of aerial in ice localities and non-ice localities.

Among the many towers the company has erected are those of the American Tel. and Tel. Co., New York City, Station WVP at Fort Wood, N. Y., Station 2XY at Deal Beach, N. J. and Station WBZ at Springfield, Mass.

HORNE HM9 RECEIVING SET

The HM9 (Mercury) Receiving Tuner and Detector manufactured by the Horne Manufacturing Company of New York and Jersey City is especially adapted for reception of broadcasting via the ordinary lighting circuit. Of course, it is conceded that generally reception over the indoor aerial is not equal to that of an outdoor aerial with the ordinary set, but with the Horne HM9 receiver, according to the company, the difference in reception is overcome in the use of this set. With this set general broadcasting can be received in the average apartment house when the landlord objects to outdoor aerials and it eliminates the use of a lightning arrestor as well as extra wiring of lead ins, etc.

The set covers a band of wave lengths from 180 to 700 meters and the radio frequency tuner and detector permits very fine tuning adjustments. All battery connections are on the inside of the cabinet, thus eliminating all unsightly wiring. The whole appearance of the set is pleasing to the eye, being finished in various colors and well decorated.

The Horne Type HM6 2 stage amplifier or the Type HM8 3 stage amplifier may be used efficiently with the Mercury set.

Positive
Contact

COMPRESSED, BAKED, SEALED
KAPACITON
INDIVIDUALLY TESTED
KONDENSERS

Perma-
nent
Capacity

ARE BETTER CONDENSERS!

Phone * Grid * Grid with fixed leak * Grid with detachable and variable leak. (Pat. Pen.)

**A CUSTOMER—FOR—ONCE or
"FOR KEEPS" ?**

It's entirely in your hand to have either sort—the customer who comes once and swears "NEVER AGAIN," or the customer who enthusiastically keeps coming and grows into a valuable asset.

Dealers tell us KAPACITONS make repeat customers. Certainly, they build a buyer's confidence in you. To begin with, a KAPACITON is a technical product, not a toy or a makeshift. We've been making the best electrical insulations over a decade. We make the best condensers now and

When better ones are made, we'll make them

KAPACITONS have positive contact through continuous copper foil, UNIFORM KAPACITY through being compressed to a definite thickness, PERMANENT CAPACITY through being baked and sealed; KAPACITONS are individually tested. They improve reception and eliminate those noises which are directly caused by a loosely wound condenser without continuous foil. KAPACITONS are moderately priced and allow the dealer a fair profit.

That's why they are

SOLD BY THE BEST JOBBERS AND DEALERS!

Meirousky

Established 1910

Jersey City, N. J.

3YQ TRANSFORMER

The Federal Institute of Wireless Telegraphy, of Camden, New Jersey, operating station 3YQ, from which regular broadcasting service is operated through the Camden Daily Courier, has placed an audio-frequency transformer on the market specially designed for maximum audio frequency amplification without distortion. This transformer is known as the 3YQ. It has been designed and manufactured by competent radio engineers of long repute in the electrical instrument field.

The voltage amplification is said to be as high as is consistent with satisfactory operation. The instrument does not distort and is free from all howling noises. The impedance is just right for operation in conjunction with the tubes on the market today; and for power amplification it is insulated to stand voltages as high as 600. Exceptionally large wire is used in winding, which means that the impedance is not made up mainly of resistance. The magnetic circuit has been carefully designed for maximum efficiency and only the best silicon steel has been used in its construction. The transformer is said to be admirably fitted for use in the new super-regenerative circuit.

EASTERN PRECISION EXPANDS

In keeping with other progressive manufacturers and attesting to the progress of radio industry, the Eastern Precision Electrical Instrument Company of Rockville Centre, N. Y., have arranged for additional space to take care of its growing business. In addition to the Company's Radiophone instruments it is now manufacturing numerous small parts, such as condensers, variable grid leaks, crystal detectors, etc. The Company is well equipped to manufacture parts to specification.

DASCO "AIRLINE" CONDENSER

D. A. Sanders of Nyack, N. Y., manufacturer of the Dasco radio products in a recent catalog describes in detail several of the Dasco "Airline" condensers. The condensers are known as types DA-3, DA-11, DA-21, DA-43, the number indicating the number of plates in the various types. The Dasco condensers are claimed to be the result of the manufacturers best effort in construction and detail. The materials are carefully selected and the workmanship is of the best.



Studio of the Electric Service Products Company of Chicago. Note the Tasteful Color Scheme of the Walls. This Picture Was Published Last Month with the Incorrect Caption

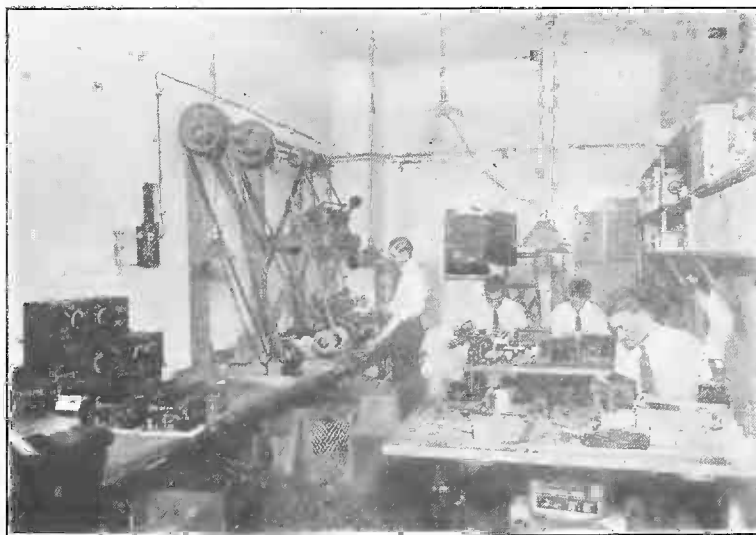

Experimental Laboratory of the Montclair Radio Corporation, Montclair, N. J.

Ask Our Service Bureau

"TUNING IN"

To the right tune is very simple when your connections are soldered with the

NEW "POST SOLDERING IRON"

(The iron with the platinum heating unit)

Removable Soldering Tip

Designed especially to cover every requirement for delicate work.

The smallest practical-efficient instrument on the market.

Attaches to any socket, Universal Current.

Fully Guaranteed.

From your jobber or write

POST ELECTRIC COMPANY

30 EAST 42nd STREET

NEW YORK

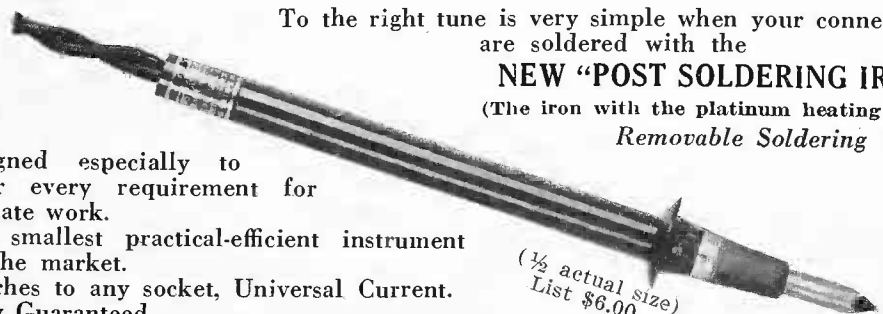

(1/2 actual size)
List \$6.00



ZELLAC

Economical Equipment Finishes

Zeller Lacquers constitute the most economical finishes on the market today for radio equipment of all kinds. They are easily applied either by dipping, brushing or spraying and completely dry in normal room temperatures within 15 minutes.

Zellac is made in all colors and can be applied to all materials. Beside the standard natural wood finishes, our Hard Rubber Black has become popular among manufacturers for finishing instrument bases as well as cabinets while our White is used exclusively by many organizations for the graduations on dials and knobs, as well as for panel work. A thin coat of our material, which has a high dielectric strength, applied to coil windings, holds them permanently in place without causing the usual undesirable effects.

We welcome the opportunity to discuss finishing problems with radio equipment manufacturers. May we be of assistance to you? In any event, write today for a copy of our free booklet, "250 Lacquer Questions Answered," using your business stationery.

**ZELLER LACQUER
MFG. CO., Inc.**

342 Madison Ave., New York

A Real Radio Show

Fall Radio Show in Chicago to Be Big One

The prospectus, which has just been issued, of the Chicago radio show—International and Annual—to be held at the Coliseum, October 14th to 21st, inclusive, indicates that the show will be one of the biggest and most important radio exhibitions yet held in the United States, and if the prospectus is a criterion, one of class as well as importance. The selection of the Coliseum gives the show an adequate setting and the prestige of the very many successful trade shows that have preceded it. It is planned as a "get-together week" for the manufacturer, offering him an opportunity of meeting the jobber, the dealer and the general public, and plans to make it appealing to each faction are being perfected. The arrangements for the show are the product of the study of practically every other radio exposition that has been staged in this country during the past year and a half, as its projector, U. J. Herrmann, himself a showman of long experience, has visited practically all of them to learn what not to do.

An outstanding feature of this show is that over 60% of the floor space has been devoted to aisle space for the comfort of the crowds that will undoubtedly attend. And it will come at a season when the buying public will show keen interest in the developments of radio during the summer months and at a time when they are looking for some diversion for the winter months. It has been announced by the management that several foreign countries have considerable exhibit space under option, which will assure an international interest.

VOLTA PRODUCTS

The Volta Engineering Company of Brooklyn, N. Y., whose standards are "accuracy, dependability and perfection" have on the market products that are well worthy of attention. Among these products is the Volta crystal set the features of which are the easily adjustable detector, sharp and simple tuning, a range doubling device and its strikingly handsome appearance. Another product, the Volta variometer is so constructed that it is perfectly balanced and cannot move once it is set. It can be mounted for both table or panel use. The Volta Variomocoupler (patent pending) is exceptional in that there are no lever or contact adjustments which the company claims permits simple and proper primary tuning.

DOUBELL RECEIVING SET

The Doubell Radio Company of New York City, claim to have solved a great many of the average consumer's problem in regard to aerials, interference and distance from broadcasting station. The solution of these problems is in the form of a receiving set having two stages of radio frequency, detector and two stages of audio frequency. The set is designed by W. J. McCord, who is already well known to the radio field.

The set which is known by the trade name Ethertrola is made up in two types; 2D2 as described and 2DL2 containing a special loud speaker built into the same set, the face of the horn coming flush with the panel. According to a report by the company a type 2D2 sent to Havana was able to consistently receive Newark and Pittsburgh, a distance of about 1,300 miles. It is also reported that a type 2DL2 installed in Babylon, L. I., receives the broadcasting programs from KYW, WWJ, KDKA and WGI on a loud speaker, an approximate distance of 750 miles. Interference from the high power stations located on the island and the nearby ship stations were readily tuned out. Despite the great distance received however, the company insists in being conservative and merely states that 500 miles consistent reception can be counted on by most anyone.

NEW TYPE CONDENSER

The Bayley Condenser Company of 105 Vandevor street, Brooklyn, have designed and tested, and are now manufacturing a condenser for which it claims new and useful features, and a tested capacity up to .0011 mfd, which does not vary. This is a die-cast product and all movable plates are cast definitely spaced, on spindle, and all stationary plates cast with uprights as a solid, close-spaced unit. The company claims sharp tuning and no shorting for this condenser. It is sold with a money back guarantee.

SYNTONE RECEPTOR- AMPLIFIER

The Syntone Receptor Amplifier manufactured by the United Radio and Electric Company of Brooklyn, N. Y., and known as type SJ-4 has been claimed by the company to have passed severe tests under adverse conditions for receiving broadcast entertainments, with highly successful results. One of the outstanding features of the set is its easy tubing adjustment. Loud and clear reception is accomplished by the turning of a single dial.

MR. DEALER— Display This Prominently

What Steinmetz Says About Radio and Lightning:

Dr. Steinmetz, who is an authority on high power electrical phenomena, was asked the following question during his visit to the Radio Congress. His reply to the inquiry follows:

Question: Dr. Steinmetz, many of us have amateur radio receiving sets in our homes. We have heard rumors that the Underwriters consider that there is a fire hazard because of the antenna and the ground connections and that certain restrictions may be placed on amateur installations. We would like to have your opinion as to the real hazard involved.

Answer: There is no hazard in the amateur radio receiving station. It involves no fire risk nor risk to life. It is merely a harmless toy, but is a great deal more than a toy. It is one of the most valuable developments of the last years, by its instructive and educational value and the recreation and pleasure which it supplies. It would, therefore, be very regrettable if by a misguided public opinion obstructions were placed in the way of the fullest and freest developments of the amateur radio station. With regard to the possible lightning risk from the grounded antenna, first—the lightning risk in a city is very remote in any case and, second—the grounded antenna rather acts like a lightning rod and exercises a protective action against lightning. Any danger from the radio power received by the amateur station obviously is ridiculous when considering that the energy of a single pound of coal would be more than enough to operate the radio receiving station continuously for over a thousand years. Certainly this is not enough energy to do harm.

From a Statement Issued by

THE RADIO CORPORATION OF AMERICA

INTERVIEWING BEYMER

(Continued from page 48)

the fact that so many of the manufacturers and jobbers were operating on a shoe-string that they were compelled to get the money in advance or C. O. D., immediately.

"This condition was radically unfair to the recognized radio dealer, and it has worked a decided hardship on him, and is another condition which will eventually 'wash out.' During that time, however, because of the second of the causes named, a great many of these manufacturers and jobbers will be forced out of business. In order to stay in business they are creating a very unstable credit system with the retailer, by offering discounts, which on the face of them, show that they have little conception of what overhead and manufacturing costs consist of. So these folks will go out of the game, and the dealer will learn the great lesson that he should buy from firms whose business methods are such as would indicate that they had the finances, or the business acumen, not only to finance their own business, but to carry the legitimate dealer the regular 30 days that he would require ordinarily, and still be in position to undertake an adequate line of advertising to back up the purchases which the dealer would make.

"All of this means that the retailer must place himself in such position that he can do business readily with concerns of this calibre. Therefore, he should be educated to have ready business statements for very large purchases, or references for ordinary credit extension, which he would present to the manufacturer or jobber, as one business man to another, and in confidence, which would be returned to him regularly in the form of added courtesy, respect and accommodation on the part of the manufacturer and jobber.

"Many failures are coming in the radio business in the next year or two, in the three divisions of the radio business, retailer, jobber and manufacturer, and this is regrettable because it is going to render the business very unstable until this condition liquidates. So, it does seem to me that the main office of THE RADIO DEALER is to educate the retailer and the jobber to buy from firms who are so situated financially that they are able to advertise nationally; who can present references of their own as manufacturers, showing that they are able financially to remain in business, and are able, as business men, to conduct their business in a way that will show them the necessary profit, so that the dealer can be assured of a continuous source of

supplies of quality goods if he concentrates on one line. This means that he cannot expect to do business with manufacturers of this character, who know costs of doing business, who know that there is such a thing as overhead, and that somebody has got to pay it, unless he would expect to give the proper references, gracefully, knowing them to be held in confidence, and from whom he would not expect other than fair legitimate discounts such as would permit him to make a profit, and permit the jobber and manufacturer to make their profits.

"In referring to manufacturers, this does not mean necessarily, that the company manufacturing the radio goods, has to be an old established company.

"The New Haven Radio Company is a relatively new company, but it is an outgrowth of a firm which is well and favorably known, and has a business standing in the community in a highly specialized line. We happen to be fortunate to have associated with us men of proper technical radio education, the proper manufacturing facilities, and the proper knowledge of what constitutes legitimate costs, profits, and methods of figuring overhead expenses; sufficient funds to enable us to undertake our advertising and sales campaign on a sound national basis, and enable us also to make haste slowly in establishing our connections, and to carry our customers' accounts the legitimate period of time the legitimate trade needs.

"I am referring to our company merely to illustrate the type of concern the dealer should do business with, as there are many others as equally well favored as the New Haven Radio Company. The dealer frequently overlooks that particular angle of his business education, that he should make as close an inquiry as to the ethical status, and the responsibility of the firm he does business with, as that firm would make of him, and until he does this the radio business is going to be a very unstable proposition."

Mr. Beymer's informative talk ended with the thought that the automobile industry, as well as the phonograph business, in their infancy, suffered as is the radio industry today.

Mr. Beymer is at heart greatly interested in the radio industry; is certain it is going to take a tremendous position in the life of the American public.

The fundamentals laid down by Mr. Beymer are vital to the trade's welfare.

Radio Call Letter

Government Has Devised System for Broadcasting Stations

There are reasons why certain letters are assigned to broadcasting stations and none of the letters given out by the Government are the result of guess work. There's a system.

This is explained in the pamphlet entitled: "Commercial and Government Radio Stations of the United States," issued by the Department of Commerce, bureau of navigation, radio service.

In this pamphlet are listed alphabetically all the government land stations, government ship stations, land and ship stations, commercial land stations, commercial ship stations and land and ship stations, special land stations grouped alphabetically by names of stations and by districts; radio compass stations on the Atlantic and Pacific coasts, alphabetically by names of stations and by call signals. This pamphlet is available at 15 cents.

The reason why some calls begin with W and others with N and K is that at the Geneva Radio Conference the countries of the world were allotted certain alphabetical groups. Those of the United States are all the N's which are governmental; the K's, beginning with KD, also governmental as well as commercial, and all the W's, some of which are governmental.

The commercial calls start with KDKA, beginning on the W's at WAA. The navy calls begin with NAA and cover all the land and ship stations down to the NU's. The special land stations have a different sort of calls—like Montclair, 2XS, or one in Nutley, 2ZH. The 2 in these calls signifies the district in which the station lies. These districts now number nine, the last in the pamphlet in hand being 9ZZ, at Kansas City, Mo.

When it comes to other countries Germany leads off, with the first group letter being A down to AM. Great Britain has all the B's and all the M's. All the I's are Italy and all the J's Japan. And so on. For instance BAG would be an English call ICA one of Italian origin and JPD one from a Japanese station.

Some stations have three letters—like WJZ—but is due to the fact that these letters were already in use when the rules were promulgated and no more three letter names are being issued. There is no set rule as to grouping of letters.

Ask Our Service Bureau, See page 18.

Radio Trade Unaffected by Inventions

Little Likelihood of Present Equipment Being Scrapped to Make Room for New Discoveries

By JOSEPH FRANK

of the Frank Radio Co., New York, N. Y.

For the past few months the public has been fed on idle rumors of new inventions about to be placed on the market to radically change radio.

This bugbear caused jobbers, as well as dealers, to hold back in their buying until the eleventh hour. A little thought will show the foolhardiness of such expectations, even if we were inclined, in general, to heed the hearsay of those who know not, and know not that they know not. Changes and improvements there will be as there have been, but revolutionary changes that would cause the scrapping of the sets and parts now on the market are not to be expected.

The most sensational inventions that have yet been introduced into radio have not caused the discard of a single part. We have added to existing parts; new and various hook-ups have been introduced, but nothing have we relegated to the scrap heap.

The radio buying season is here, and jobbers and dealers have begun to lay in their supply, knowing full well the lesson they learned last year. They know that, although potential output is greater this year than last, it is smaller in proportion to the expected increase in demand. They know that any projected fundamental changes, if there were any, have been thrown upon the market ere now so as to get the benefit of the season's opening.

All hesitation has vanished and manufacturers everywhere report excellent orders.

Another cause of over-cautious buying has been a fear lest prices should drop after a stock was put in. Some price slashing by panic-stricken firms and firms financially weak trying to save themselves, there has been. But in general the goods thus sold have been faulty and inferior and have in the end proved more expensive, if not entirely worthless, to their purchasers. There has been slight fluctuation, but quality merchandise has held fast and firm, and prices have shown a slight tendency to increase rather than decrease.

Now that the larger manufacturers have issued their catalogues for the season, there can scarcely be any more question on the score of undulations

in price, at least from the big ones.

As manufacturers become overwhelmed with orders, and as they find that their raw materials become scarcer and therefore higher in price, they may be compelled to raise prices, or even find themselves unable to fill orders, as was the case last fall and winter. Considering the number of broadcasting stations that have been built throughout the length and breadth of this country since last winter, and the rate at which they are

daily increasing, this seems not at all unlikely.

The scare of vital changes in radio and the fear of dropping price, seem now to have faded away into thin air, as the radio season has actually arrived without either materializing.

As a result of negligible buying during the summer months, a greater rush to fill the gaps is now taking place. There will undoubtedly be many times this season on which it will be impossible to fill this sudden demand.

The Future of Radio

Radio Has Not Come Suddenly After All

By E. J. Nally, President Radio Corporation of America

Contrary to the popular understanding radio has not come to us suddenly. It has been under development continuously during the past twenty-two years. Commercial radio communication, that is, overseas radio telegraphy, has reached a high state of development and has found its place in the commercial world. Radio is now carrying a large part of the telegraph traffic between the United States and Europe and between the United States and Japan, the total volume of traffic constantly increasing.

Radio telephony has been under development during the past fifteen years, and during the late war was successfully used for both one-way and two-way communication.

Popular radio—relatively short-distance radio telephone broadcasting is the outcome of the realization of the vast possibilities of one-way transmission of news matter, vocal and instrumental music, lectures, sermons, etc. Radio phone transmission from central, organized sources of information and entertainment makes it possible for the citizen to receive this service through the small instrument involved in purchasing a radio phone receiver.

It is not communication in a two-way sense; radio broadcasting is the employment of a fairly well developed science to a new use. Broadcasting is the recent development—not radio.

The future of radio telegraphy, therefore, is assured. It already has

a healthy and well defined field. The future of radio phone broadcasting is another matter and in this we can speculate with only the imagination limiting.

We may visualize the future of radio as developing in quantity and quality perhaps as news distribution has grown since Franklin's time, and as organized entertainment has grown in popular favor since the days of the Globe Theatre.

Radio phone broadcasting here gives us a new facility by means of which these potent agencies of civilization may be strengthened and made more popular and universal.

Broadcasting already has given the condition of isolation a new meaning. Isolation now, if it exists, must be a desired condition. No man, no family, no matter where located geographically with regard to railroads or wire telegraphs, need be beyond the range of daily radio broadcasted news, etc.

It is difficult to understand how any thinking person can believe that broadcasting will not be further extended.

The facility of the radio phone is here. It is available. If there is anything nebulous about its status, it is only that its vast, significant possibilities have been realized so recently that there is not yet agreement as to what its most useful application shall be.

In the meantime it is serving—making its way here and there and getting acquainted, so that we may well believe that in time it will occupy a destined place among the great forward steps of civilization along with the newspaper, the magazine, the rural phone and the automobile.

MANUFACTURERS
JOBBERs—

Have You Seen
The Radio Dealer
WEEKLY

?

This weekly folder issued by the Service Bureau of The Radio Dealer lists inquiries of dealers all over the United States and Canada

SEND FOR SAMPLE COPY TODAY

Service Bureau

THE RADIO DEALER

1133 Broadway

New York City

For the Livest Business Man in Your Town

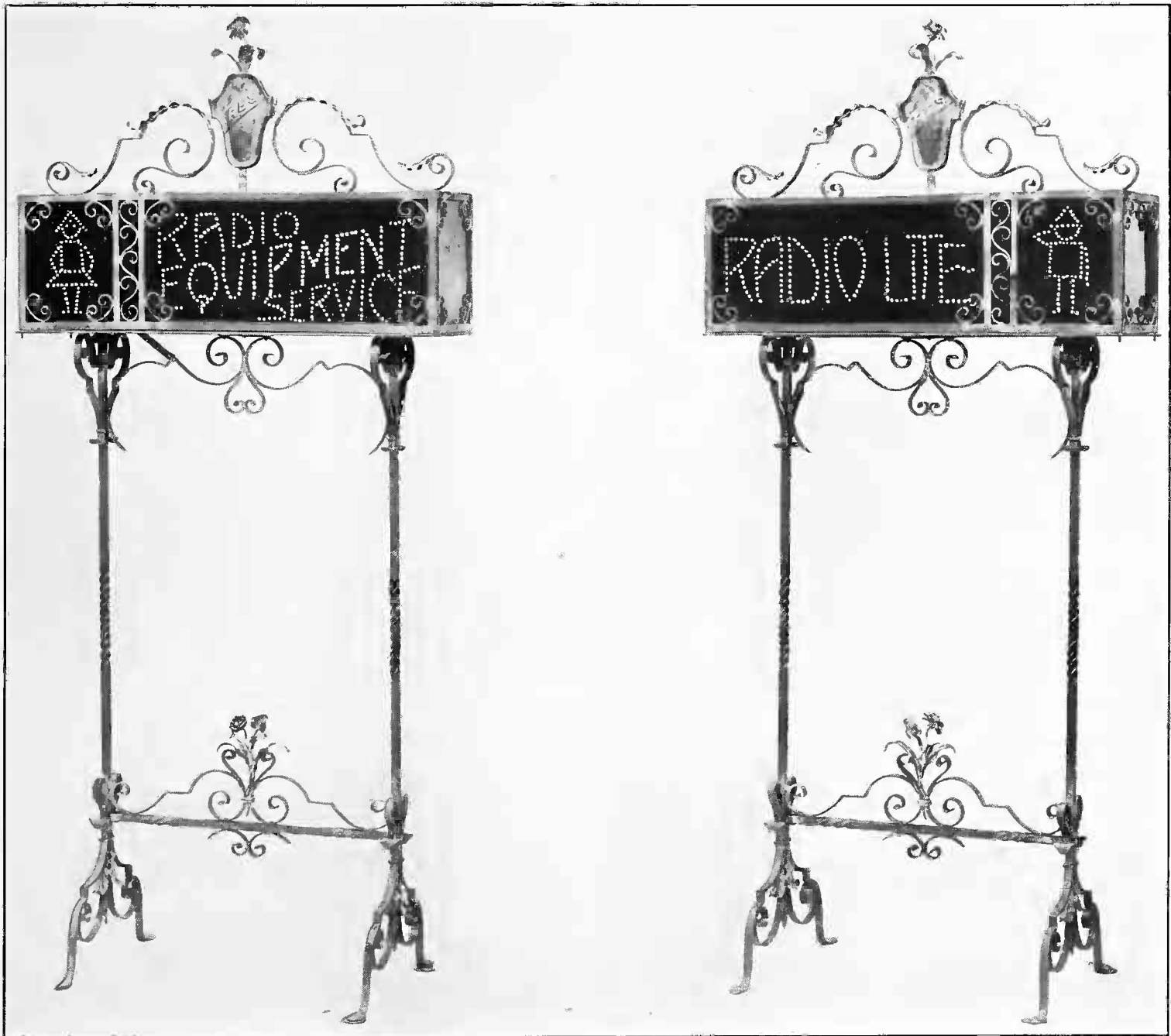

The RADIOLITE sign and talker pictured here will sell quickly to the livest business man in every town. He will buy on sight. Take this advertisement out of the paper and show the design to the owner of your best hotel, to the president of the new bank, to the publisher of the daily newspaper. Show it to a real live-wire and you will begin to find out just how easy it will be to sell this latest novelty in the radio business.

Here's some of the selling points that will make this a winner for you--

A flashing electric sign.—A different design on either side, a flashing figure on the side of the sign that assumes half a dozen different positions—every sign made to special order according to the wishes of the buyer—a wrought iron model that is indeed a thing of beauty.

Special designs for indoors with seven-foot stand as pictured, or outdoor types that can be hung just like any other electric sign.

Equipped with a high grade radio set that will bring in broadcasting perfectly. The set sold complete with all batteries, and plug for wiring in the sign. Screw in the socket and book up the aerial.

Watch the crowd hunt for the loud speaker—it's in "the sign that talks."

Regular Discounts for live wires,—and NOT high-priced. Trade name registered U. S. Patent Office.

RADIO EQUIPMENT SERVICE

Manufacturers

500 Fifth Ave.

New York, N. Y.



**Na-ald
V. T. Socket**

Takes bulbs of all sizes. Double wipe contact with bottom and side pressure. Contacts of laminated phosphor bronze. All excess metal eliminated, aiding reception. Moulded from genuine Bakelite. Unaffected by heat of bulbs or soldering iron. Special protected slot with exterior reinforcement. Quality combined with low price by virtue of quantity production. Price 75c. each. *Special proposition to dealers and jobbers.*

ALDEN-NAPIER CO.
52 Willow St. Dept. F Springfield, Mass.

KNOCKDOWN APPARATUS

Knockdown variometer with brass fittings, boxed.

Knockdown variocoupler with brass fittings, boxed.

All size variocoupler rotors.

Two slide tuning coils.

Crystal sets assembled or knockdown.

Ritter Wood Work Co.
232 Canal Street New York City



35c each; 3 for \$1.00

**Na-ald
Genuine
Condensite Dial**

The dial that runs true

Numerals engraved on bevel and knob so shaped that fingers do not hide them. Thin edge with clear graduation to make accurate reading easy. Concealed set screw in metal insert. Will not warp or chip. Finish and enamel permanent. Low price with this quality possible only through quantity production. *Special dealer and jobber proposition. An opportunity.*

ALDEN-NAPIER CO.
52 Willow St. Dept. F Springfield, Mass.

Prompt Deliveries

Jet black high finish panels, .01 per inch, 3" nonbreakable, flexible dial with knob\$.70

3½" Vario-Coupler.. 2.00

Complete Receiving Set, \$25.00

Beau Ivorie Novelty Co., Inc.
127-129 Van Buren Street
Newark, N. J.

Ask Our
Service Bureau

MULTI-TERMINAL PLUG

The Howard Radio Company of Chicago recently issued a new telephone plug known by the name of the Multi-terminal. This plug has been brought out to facilitate two or more phones being used on the same plug and at the same time. It provides positive connection for all standard receiver terminals by merely inserting the tips into the holes provided. From one to six pairs may be accommodated in such a manner that electrical efficiency is assured. The internal wiring and connections of the plug permit of a variety of connections as two or more phones connected in series or in parallel. A chart is furnished with each plug showing the recommended manner of connecting various numbers of phones.

Variety of Radio Horns

The Standard Metal Manufacturing Company of Newark, N. J., feel qualified to state that they are the largest and oldest horn manufacturers in the United States, having made various kinds, sizes and styles for the talking machine trade for many years, running into thousands, selling such concerns as Edison, Victor, Columbia, Aeolian, Pathé and others. Also, manufacturing a variety of bulb horns for the automotive trade for American Locomotive Co., known as Alco, Locomobile, Packard, Pierce Arrow, Winton, Haynes, and Ford.

Besides these, they have made special design horns in large quantities for the electrical trade on telephone work and loud speakers. The company is at present making five different horns and feel that they have the facilities to design and manufacture a horn that will give entire satisfaction as to contour and shape, as well as mechanical workmanship and finish. Nothing is used in the construction of the horns but quality material to avoid a possible vibration and blast. The company is now working on a new horn that they hope to have ready for the market very soon.

CREATING CREDIT
By MELLVILLE HICKS

The retailer and jobber who is honest is never afraid to "make a statement" when he asks for credit. He should make every effort to acquire credit, buying on strict terms rather than via the special discount price.

Often the manufacturer and jobber who will not extend credit is working along get-it-now lines. Reputable houses want to establish credit arrangements with customers. It's good business.

TITAN-O-TONE \$10

Including Headset and Aerial with Double Titan-o-Tone Headset \$12



A well made and efficient outfit everybody can afford. Discounts 40 and 10.

For Jobbers and Manufacturers!

	Per 100 Net
Crystal Wash..	\$10.00
Mountable Crystal	4.50
Detector Hinged Knob	12.50
Large Knob and Set Screw...	2.50
Large Contact Switch	8.00
3" Aluminum Dial	8.00

Send for Samples
T. F. RADIOPHONE CO.
Manufacturers
667 Coney Island Ave., Bklyn, N. Y.
Telephone Windsor 7736

**MERCURY
RADIO PRODUCTS CO.**

We manufacture
a full line
of Quality
Products.

Loose Couplers
Crystal Sets
Bulb Sets

Write for Details

**51 Thomas St.
ORANGE, N. J.**

BUTLER WITH RADIOBAT

The Multiple Storage Battery Corporation, manufacturers of A and B storage batteries have placed R. H. Butler in charge of sales and advertising for their radio division.

R. H. Butler has been associated with the merchandising of radio products for three years. He has been connected with *Radio News*, Metropolitan Advertising Company and Lincoln Advertising Service. During that time, he has been actively connected with several of the most prominent advertising and selling campaigns in the radio industry.

The corporation makes an exceptionally lightweight rugged type of A battery and has just completed a storage B battery with a practical jelly electrolyte. These batteries are being marketed under the registered trade name "Radiobat."

An extensive selling and advertising campaign will be launched this fall calling for dominating space in leading national magazines and newspapers as well as the radio press. The sales policy will also include the liberal use of selling helps and various forms of sales cooperation for the benefit of the radio dealer.

The newly enlarged plant of the Multiple Storage is located at Jamaica, L. I., with a capacity of 5,000 A Radiobats and 10,000 B Radiobats per week, in addition to the automobile, farm lighting, aeroplane and other types of batteries for various purposes.

PAUSIN CONDENSERS

The Pausin Engineering Company of 123 William St., New York City, announces the release of their Two-in-One line of variable condensers. A novel feature of this variable condenser is that the multi-plate rotary has been provided with an independently adjustable capacity which is arranged to synchronize in initial adjustment with the position of the main rotary element, the vernier being at all times in a position to establish the closest possible plus or minus refinement of the condenser capacity regardless of the position of the main element. The company claims rapid and close tuning as a result of this design. The condensers are of high class workmanship and are backed by the Pausin guarantee.

THE CRYSTAL SET

No matter to what extent radio will develop, no matter to what heights the scientific minds will reach, it will ever be recorded that the crystal set made the wonders of radio a possibility.

FREDERICK H. PRUDEN INCORPORATED



A name in Radio that sets a new standard for Quality, Workmanship and Service. An organization of experienced radio men that have been conservative rather than impulsive.

In a business that has been literally "talked to death," a business that has been greatly damaged in public respect and support by insane publicity and ignorant merchandising methods, our organization has had the sense to work hard, use its intelligence and keep its mouth closed tight.

Now, for the first time in over seven months, we make our first announcement to the jobbers and dealers of the country—of the best products on the market, giving maximum satisfaction and service—at the right prices. That is why you will find the best radio jobbers and dealers featuring our

Quality Radio Products

Dictograph Headsets Dictograph Loudspeakers
Cutting and Washington Radio Sets
Universal 3-Plate Vernier. 23 and 43-Plate Condensers
Keystone Moulded Variometers and Variocouplers
Radio Storage "A" and "B" Batteries
Rheostats—Sockets—Crystal Detectors
Three-Inch Bakelite Dials

We are *direct* factors for manufacturers of products of the highest reputation. Jobbers and dealers get acquainted with the biggest proposition in Radio—TODAY!

Frederick H. Pruden Incorporated

FREDERICK H. PRUDEN
President

GEORGE R. HOLMES
Vice-Pres. and Treas.

Lerner Building

General Offices

Jersey City, N. J.



"The Seal of Quality"

SPECIAL AUGUST PRICES



Hard Vulcanized Rubber Polished Knob

Hand Buffed—Nickel Parts
Non-Binding Bearing
500 Lots, 16c Each



Composition Knob

Tapered and Highly Polished
500 Lots, 14c Each



Composition Knob

Hand Polished and Buffed
500 Lots, 12c Each

Further Reductions on Larger Quantities
Pink-a-tone Receiving Set Complete
\$12.50

Special Prices on Filament
Rheostats

CHAMPLIN MFG. CO.

90 WEST BROADWAY
NEW YORK

Tel. Barclay 8676

Est. ablished 1860

Henry Hyman & Co. Manufacture Bestone Line

The Henry Hyman and Company, Incorporated of New York City manufacture a complete line of wireless apparatus under the trade name Bestone. The line includes not only individual parts but a wide range of complete receiving sets which will be placed on the market in a short time.

lent design of Bestone products may be had from the accompanying illustrations of the Bestone V. T. socket and compact dial filament rheostat.

Realizing that extreme precision is necessary in the production of wireless apparatus Bestone products are scientifically and mechanically correct in

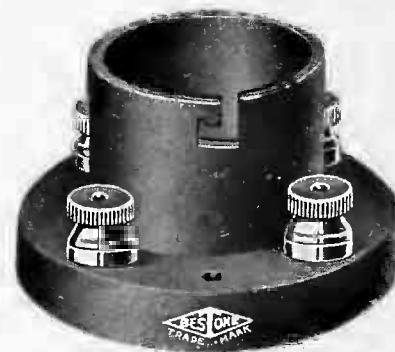
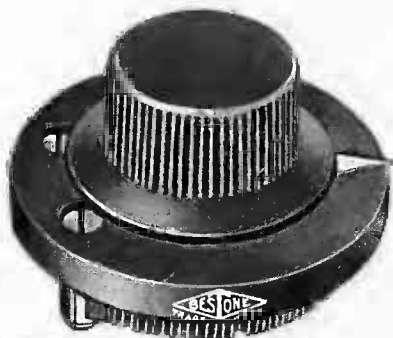

Henry Hyman and Company have had extensive experience covering many years in the manufacture of high grade electrical specialties for household and commercial use so that the organization devoted to the manufacture of Bestone radio apparatus possesses the experience and efficiency necessary to produce high grade wireless apparatus. An idea of the excel-

every detail. The new Bestone illustrated catalog, which also contains a glossary of radio terms, is attractively and neatly gotten up.

The company has had long experience in the metal goods field and to those who know will readily associate the name of Hyman with the well known Hylite products.

SUNRAID NEW RHEOSTAT

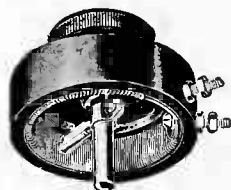

The Sunraid Radio Company of New York City has issued a new type of rheostat, which differs from the ordinary rheostat in that the contact with the resistance element is made by a ball bearing which rests on the open end of a small tube fixed to the shaft. Inside the tube is a wire spring that presses the ball-bearing against the resistance wire, assuring a firm and smooth contact. The ball bearing minimizes the wear on the resistance wire and permits of a fine adjustment. The material employed is of the highest grade.

RADIO DUCT

Radio Duct, a product recently placed on the market by the Columbia Electric Motor Company, of Hoboken, N. J., is a form of wire for use in hook-ups which is said to obviate the necessity for aerial and ground. The invention is the result of research by radio engineers employed by this firm into the reasons for loss of maximum efficiency in the ordinary radio set.

The wire consists of an inner, thick strand of copper wire, around which is placed two windings of small circumference wire. It is claimed for this form of wire that inductance in parallel wires is completely done away with, giving maximum efficiency and making the most of weak signals.

The product is completely protected by patents pending. According to Mr. Schimpf, of the Columbia Electric Motor Company, several sets which have been constructed with the use of this material have shown astounding results, and are now on exhibition at various places in New York City.

PHILLY SEPTEMBER SHOW

The American Radio Association which staged the successful radio shows in Pittsburgh and Detroit last spring announce that the first Philadelphia show, which was postponed from June until this Fall, will be held in the Industrial Exposition building in the Quaker City, September twenty-seventh to thirtieth, inclusive.

Philadelphia, the third largest market in America, did not develop interest in the industry as quickly as some other cities, but with the impetus which has been given during the past summer and spring the dealers, jobbers and manufacturers are now looking to this rich field as their next campaign grounds. Surrounded by large populous cities Philadelphia, in addition to its almost two million people, is the trading center for three million more.

A general invitation to dealers within this trading area is being sent out by the managers of the show who plan to make this a mart for buying fall and winter supplies. Special days will be reserved for these visitors and facilities for the transacting of this business will be afforded.

L. T. Davies will be in direct charge of the affair, and will be assisted by the members of his experienced staff as well as by the Philadelphia dealers and jobbers. The usual educational features which the American Radio Exhibitors' Association afford at their shows will be on the program at this show.

DEALER TRANSMITTER

A novel and useful transmitter that should prove of benefit to many dealers and jobbers is one of the features at the Grand Central Palace Radio Merchandising Fair. The set is demonstrated by the Sprague Radio Corporation of New York City. This set can be placed anywhere in a building. Without waiting for some broadcasting station to transmit, the set will transmit phonographic music, etc., with sufficient energy to be received plainly on the floors above or below. The company has had several years' experience in making marine wireless transmitters and receivers for the U. S. Navy and U. S. Merchant Ships.

FIRST DUBILIER DIVIDEND

The Dubilier Condenser and Radio Corporation has declared its first quarterly dividend of \$2 a share on its preferred stock, payable Sept. 1. The corporation reports that earnings in its first three months of operation—May, June and July—were more than five times the amount required for the preferred dividend for that period.

Radio Manufacturers

Make New Friends at the
Permanent

RADIO FAIR

The Official Buying Center of the United States

Under the Personal Direction of
RAYMOND FRANCIS YATES

Radio Editor of The Evening Mail

GEORGE T. KEEN, Business Manager

At the present time the radio industry is badly in need of a centralized exhibition of reliable merchandise where buyers may come and make their purchases with a feeling of security. The Permanent Radio Fair will be such a place; it will be the official radio buying center of the United States. Buyers from every part of the country will visit the Fair because it will save them time and worry in selecting their merchandise. The public is invited in between the hours of 1 P. M. and 10.30 P. M. Mornings reserved for buyers only. Only apparatus of recognized standing will be displayed and nothing will be accepted that does not meet with approval of Mr. Yates, Director of the Fair.

During the past eight years ready-to-wear goods, automobile accessory and toy fairs have been run under the management of the hotel with the object of accommodating its patrons in making their purchases. Some idea of the success of these fairs can be gained from the fact that over \$8,000,000 in orders were placed at a recent toy fair.

The Permanent Radio Fair will be held in the famous Red Room of the Hotel Imperial, where 165 glass-covered compartments, ranging in size from 24x24x36 inches to 36x36x36 inches, have been provided. These spaces are being rented at a charge of from \$1.00 to \$3.00 a day.

A large portion of the available space has been contracted for by many of the leading radio manufacturers, and immediate action will be necessary for those who wish to display their apparatus. Application for space should be made by wire to the

PERMANENT RADIO FAIR

Room 165, Hotel Imperial, Broadway and 32nd St.
NEW YORK, N. Y.

*Let the Men Who Buy See Your Merchandise
The Radio Fair Opens in September and Closes in
May, 1923*

UNION RADIO

Apparatus and Accessories

Generate and Broadcast

SATISFACTION, PROFIT
AND GOOD WILL

Receiving Sets

Two Step Amplifiers

Tube Receptacles

Variable Condensers

Condensite Dials

Telephone Tip Jacks

Write for our liberal
dealer proposition today!

UNION RADIO CORPORATION
200-MT. PLEASANT AVENUE, NEWARK, N.J.
NEW YORK OFFICE 116-WEST 32ND-STREET.

Radio Securities

By FRANK T. STANTON

The past month was a very inactive one in the Radio shares. Early in August Radio common sold down to 4½, the selling being principally by discouraged stockholders. Radio preferred remained practically unchanged.

Reynolds Spring Company. Reynolds Spring busted wide open and as this goes to press it is offered at \$25.00 per share. General dissatisfaction by the promoters is said to be responsible for this break.

De Forest Radio Tel. & Tel. A good demand for the De Forest Radio Tel. & Tel. shares developed, taking up all the loose stock offered in the street.

Canadian & English Marconi. These stocks were quiet awaiting developments of the important meeting taking place the latter part of this month.

Dubilier Radio. The stock was steady and acted very well around \$9.00.

Radio Corporation. When the news of the Irish seizure of the cables crippling the Cable Service became known all newspapers wrote how wonderfully the Radio Corporation of America handled the enormous business that was diverted to them. This brought out buying orders in the stock and the common rallied to 4¾ and the preferred to 3¼. As we approach the cool weather the demand for these shares becomes greater. Inquiries are coming in daily on all sorts of Radio companies. We look for a very big market in Radio shares this winter.

Following are the quotations for some of the principal Companies:

	Bid	Asked
Amer. Marconi unstamped.....	6	8
Amer. Marconi stamped.....	5c	20c
Canadian Marconi	2½	3¼
De Forest Radio	6	10
Dubilier	8½	9
English Marconi com. & pfd..	10	14
Federal Tel. & Tel.....	5	6
International Tel. & Tel.....	52	56
Marconi Int. Marine.....	7	8
N. Y. Tel. Pfd.....	107¾	107¾
Radio common	4½	4¾
Radio preferred	3½	3¼
Reynolds Spring	22	25
Spanish Marconi	1	3

ISSUE NEW CATALOGUE

The Premier Radio Corporation of America, located at 78 Fifth Ave., New York City, announces that its new catalogue is ready for distribution. This corporation manufactures a very complete line of parts and sets. The new catalogue is complete in every detail, attractive in appearance and interesting throughout.

FORD MICA PRODUCTS

The Ford Mica Company, Incorporated, of 14 Christopher St., New York City, are manufacturing a guaranteed to give satisfaction line of amplifying and radio frequency transformers, also mica condensers of all capacities, choke coils, etc. The quality of material and workmanship of the different parts should insure satisfied customers.

NAVY TYPE RECEIVER

The latest developments of the radio art are embodied in the design of a navy type receiver marketed by Charles R. Ablett Company of New York City. This instrument is of unusual efficiency combined with beauty of design and finish. It is equipped with binding posts which are normally short circuited for 300 to 6,800 meters, by which wave lengths up to 23,000 meters may be received by the attachment of loading coils. The normal wave length is from 300 to 6,800 meters. Capacities of proper loading coils for above are: Primary, 50; Secondary, 50; Tickler, 30 millihenries. While the receiver is provided with a "standby" or untuned circuit, it also has an unusual degree of selectivity. Although primarily designed for the more advanced fields of radio work, or the laboratory, the simplicity of arrangement and beauty of finish make it unusually desirable for the radio club or for the individual who desires the finest equipment obtainable for home or office.

Either of two tuned circuits, or an untuned secondary may be used through the operation of a switching mechanism.

The handsome containing case is of heavy mahogany, in which the receiver is mounted under Bakelite-dilecto panel. A switch is provided for protection of detector during transmission and also for reception of vacuum tube.

ALL SENSITIVE CRYSTAL

The Galena Crystal Company, of Brooklyn, N. Y., is marketing a crystal that the company claims to be literally all sensitive. Each crystal is guaranteed to be tested and found to be of uniform sensitivity. Mr. Bluman, a member of the company, has devised a method for moulding crystals which does not affect the original qualities of the crystal, generally due to the tremendous heat of the moulding, even when Woods metal is not used. The crystal is also guaranteed to bring in broadcasting music much better than the ordinary crystal under similar conditions.

EX-TONE NOW PATENTED

James Spavento of Brooklyn, N. Y., has just perfected a device known as "Ex-tone." This apparatus is made to fit all types of phonographs, or even a horn shaped paper megaphone, and will tend to amplify the volume of sound.

"Ex-tone" is built on a new principle, that is, it has two separate tone chambers that attach to the two phone receivers, and have a decided tendency to increase the volume of tone.

ZETA RADIO FREQUENCY TRANSFORMER

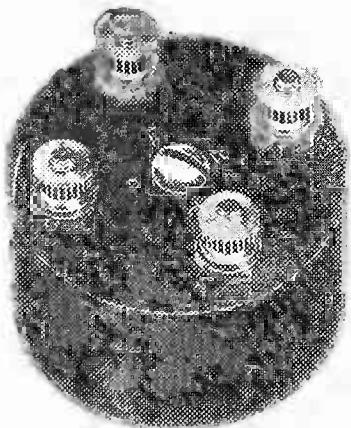

SCIENTIFICALLY TESTED
FOR ALL CHARACTERISTICS

LIST PRICE, \$3.50

Satisfaction Guaranteed

JOBBERs and DEALERs

WRITE FOR DISCOUNTS

CLARK & TILSON

51 East 42nd St. New York

Paragon Sells on Results Not Claims

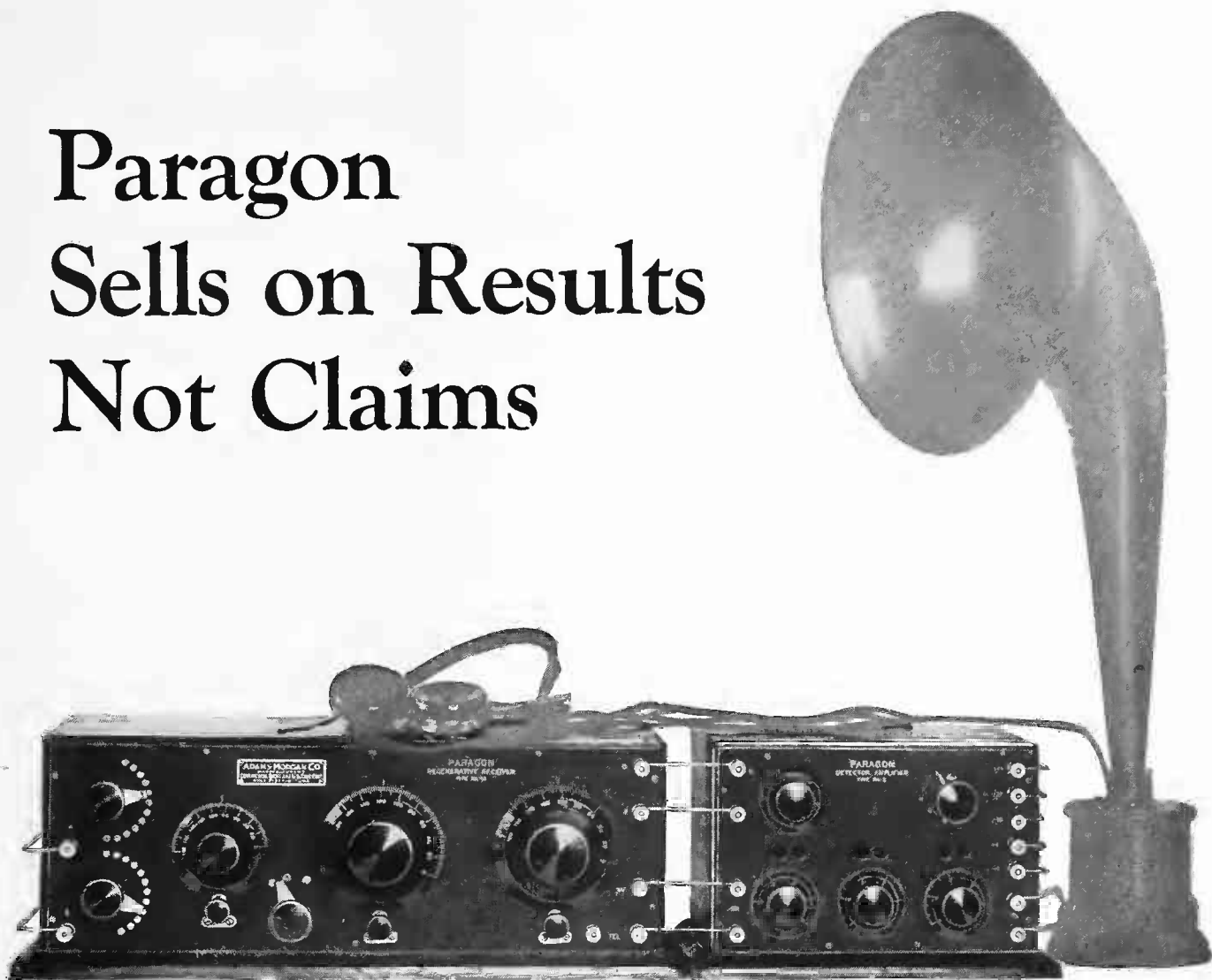

Type R-A-10 Receiver

Licensed Under Armstrong Patents

D-A-2 Detector-Amplifier

Also Manufacturers
of
PARAGON

Radio Telephone
Transmitters
V. T. Control Units
Rheostats
Potentiometers
V. T. Sockets
Amplifier Transformers
Detectors
Control Dials
Amplifiers
Receivers
Switches
Variometers

You can tell your customers this

In 1915 the *first* regenerative receiver, Paragon, was manufactured.

In 1916 Paragon effected the *first* transcontinental reception (not prearranged) from New York to California.

In 1917-18 Paragon receivers, due to greater sensitivity and selectivity, proved superior to all others in interception of enemy signals by the U. S. Army and Navy.

In 1921 Paragon effected the *first* transatlantic amateur reception, registering signals from 27 American amateur stations at Ardrossan, Scotland, a distance of 3500 miles.

In 1922 Paragon Products are safe to buy and easy to sell in a market in which it is difficult to judge values.

Some good territory is still open for reliable jobbers and dealers. Full details with catalogue, price lists, discounts, etc., will be sent promptly on request.

ADAMS-MORGAN CO., 12 Alvin Ave., Upper Montclair, N. J.

PARAGON

Reg. U. S. Pat. Off.

RADIO PRODUCTS

WHAT THEY SAY!

ANSWER FROM FRANCE

*** by way of remark let us state that we received a total of 46 replies from our July advertisement, one being from France, and that we have been successful in closing a moderate amount of business therefrom.—Chicago, Ill.

LOOKS LIKE A WINNER

Your Journal arrived and she looks like a winner.—Needles, Calif.

THE ONLY ONE

We approve of THE RADIO DEALER very much. It is the only magazine for the dealer. We wish you great success.—North Wales, Pa.

EXCELLENT MEDIUM

*** We consider THE RADIO DEALER an excellent medium and have other accounts soon to be placed in it.—Chicago, Ill.

LIKES THE SERVICE

Have had two copies of your paper and with the service you give every retailer should be a subscriber.—Springport, Mich.

GOT THE RESULTS

You may be interested to know that the replies we received from addresses of manufacturers of telephone cords furnished us by your service bureau was surprising in number and very satisfactory from a purchasing standpoint.—Ridgefield Park, N. J.

LIKES THE WEEKLY

*** Hoping that you will look it up at your end as we think a lot of this small paper. We want the weekly every week.—Lancaster, Penna.

EXCELLENT PUBLICATION

*** Permit us to congratulate you more heartily upon the excellent trade journal that you have published. We trust you will be able to keep up this splendid work.—Buffalo, N. Y.

LIKES OUR STYLE

*** We wish to congratulate you on the make-up of this magazine.—Richfield Springs, N. Y.

THE MAGAZINE HE NEEDED

Have just finished reading the sample you sent and feel that it is just the magazine I need.—Portland, Oregon.

DEALERS LOOKING FOR IT

THE RADIO DEALER is what many dealers have been looking for.—Cleveland, Ohio.

In response to a request from a well known advertising agency THE RADIO DEALER publishes herewith a few letters and quotations from letters as received from the trade which will give some idea as to the standing of this publication.

In view of the fact that every one of these quotations came unsolicited THE RADIO DEALER believes in all fairness it would not be best to broadcast the names of the writers, although EVERY SALESMAN and REPRESENTATIVE of this publication will be able to produce on short notice names and addresses for every letter quoted. The originals are on file in our New York office and may be seen on request.

A WORD OF THANKS

*** We want to take this opportunity to thank you for your interest and co-operation and hope to reciprocate in the very near future.—Chicago, Ill.

FROM A RETAILER

*** Want to offer my congratulations on the splendid magazine you are putting out.

With well wishes, for your continued success ***.—New York City.

SERVICE WAS SURPRISING

We are in receipt of your letter of the 11th *** We wish to extend our thanks to you for this effort at the same time frankly telling you that it is our first experience in co-operative efforts along this line and assure that we appreciate it regardless of the success made in soliciting the requirements of the prospects you forwarded us.

*** Should it be within our power to reciprocate some time in the future you can rest assured it will be gladly done.—New York City.

A SATISFIED ADVERTISER

*** We are highly pleased with the results we are obtaining from advertising in your wonderful paper, especially during the recent dull period through which we have passed, and I also wish to compliment you upon the tremendous growth of your magazine, which we feel confident to say that it is getting before the right class of trade and giving results to your growing list of advertisers.

Good luck to you and your organization *** believe me to be, A Satisfied radio Dealer Advertiser.—Philadelphia, Pa.

YOUNG BUT NECESSARY

*** We have a copy of your young but very necessary journal ***.—Dorchester, Mass.

A GREAT ASSET TO ALL DEALERS

*** May we say that THE RADIO DEALER is a great asset to all dealers in wireless equipment and is indeed doing something worth while in instigating a national organization of radio business men.

THE RADIO DEALER is to be commended on its fine start and showing. May the good work keep up.—Brooklyn, N. Y.

A PAPER OF SERVICE

*** Recognizing that a trade paper such as yours can be of wonderful service to the better manufacturers and better dealers, we wish to co-operate with you in any way possible.—Newcastle, Pa.

FROM AN AGENCY

*** We congratulate you upon foreseeing the need of a publication such as THE RADIO DEALER, and upon the splendid business-like way in which you are undertaking the task of making THE RADIO DEALER fill that need.

That we give your enterprise its merited support and co-operation in tangible form, Mr. _____ suggests that we place some advertising with you. . . . Our appreciation of the necessary and serious service you are undertaking for both the radio fraternity and the radio public ***.—San Francisco, Calif.

FROM HIS CLIENT

*** We wish to thank you for the excellent service you are giving us and assure you it is appreciated.—San Francisco, Calif.

THE SERVICE BUREAU

*** We wish to thank you for the results obtained for us in connection with condensers.—Birmingham, Ala.

FROM A JOBBER

*** We believe every dealer should subscribe for your journal, it being the best in the trade.—Albany, N. Y.

Are You Making Money Out of Radio ?

THE RADIO TELEPHONE HANDBOOK

By H. G. Cisin, M.E.

TELLS YOU HOW

IT CONTAINS THE FOLLOWING FACTS ABOUT RADIO YOU WANT TO KNOW

What Radio Apparatus to Stock
 What Class of Radio Sets to Handle
 The Operating Principles of Radio
 The Various Types of Radiophone Receivers—the Best Methods of Adjusting Them
 How Crystal Detectors Work
 What Crystals Work Best
 How the Vacuum Tube Works
 What Is Meant by Cascade Amplification

The Principles of Regeneration
 How to Select Telephone Head Sets
 Types and Uses of Tuning Devices
 The Meanings of Everyday Radiophone Terms
 How to Select and Install the Demonstration Set
 What Service to Give in Connection with the Sale of Radiophones
 How to Utilize Newspaper and Other Publicity

With This Book You Can Tell Your Customer

The Best Way to Erect His Aerial
 Which Is Preferable, a One or a Four-Wire Aerial.
 What Determines the Length of the Aerial
 Underwriters' Requirements
 License Requirements
 How Best to Protect Against Lightning
 Why Some Radio Sets Are Simple and Others Are Complicated
 Which Sets to Recommend
 What Batteries, if Any, Are Necessary
 How High to Put the Aerial
 When an Indoor Aerial Can Be Used
 Under What Circumstances Ground Connection May Be Dispensed With
 When a Loud Speaker May Be Used
 What the Loop Aerial Is

How Amplification May Be Obtained
 Whether a Vacuum Tube May Be Used in Conjunction With a Crystal Detector
 Whether More Than One Radio Receiving Set May Be Connected to the Same Aerial
 The Correct Way to Measure Aerial Length When Shielding Is Necessary
 How to Check Up the Condition of the Storage Battery
 How to Eliminate Howling
 Causes and Remedies for Weak Signals and Local Noises in Connection with Vacuum Tube Sets
 How to Locate Faults in Vacuum Tube Radiophone Receiving Sets

Single Copies.....Price \$1.00
 One Dozen Lots.....33% discount
 Four Dozen Lots.....40% discount

Special Discounts on Quantity Orders

Attractive Exclusive Proposition for Distributors

Published By

THE ALLIED ENGINEERING INSTITUTE
 1400 Broadway, NEW YORK CITY

FILL THIS OUT, TEAR OFF AND MAIL

THE ALLIED ENGINEERING INSTITUTE
 NEW YORK, N. Y.

GENTLEMEN:
 SEND.....COPIES OF THE RADIO TELEPHONE HANDBOOK FOR WHICH
 FIND ENCLOSED \$.....
 NAME.....
 ADDRESS.....
 CITY.....
 STATE.....

In Response to Demand

THE RADIO DEALER WEEKLY

Published by The Service Bureau
of THE RADIO DEALER

announces:

A SPECIAL OFFER

Effective September 1st,—

listings in the WHERE TO BUY RADIO EQUIPMENT guide appearing in THE RADIO DEALER WEEKLY each week, will be sold at the very low rate of

TEN DOLLARS UNTIL OCTOBER 1, 1923

for each two line listing. Less than THREE CENTS A DAY. To include a free subscription to the WEEKLY.

The Radio Dealer Weekly Where to Buy Guide reaches the widest range of any similar list on the market today.

Where a number of these listings can be handled at one time the cost of changes, etc., will be materially reduced, and it is only thru the savings thus effected that this special offer can be made.

THIS OFFER IS FOR A LIMITED TIME ONLY AND WILL BE WITHDRAWN AT AN EARLY DATE. After which the regular charge will be twenty-five dollars per year.

USE THIS COUPON

THE RADIO DEALER WEEKLY,
1133 Broadway, New York, N. Y.

Please list us as manufacturers of in THE RADIO DEALER WEEKLY until October 1, 1923, beginning with the next issue, for which we agree to pay ten dollars for each two line listing. It is understood we are to receive the WEEKLY free as long as this listing appears.

Signed (Pres., etc.)

Firm name and address.....

Please typewrite or print exactly as it should appear in the WEEKLY

INSURE YOURSELF AGAINST TUBE "COME BACKS"

AND WIN SATISFIED CUSTOMERS BY INSTALLING A W-B-L VACUUM TUBE TESTER



Type 1001
Showing a Tube Mounted for Test.

The only instrument made which will tell you in a simple, direct, and not-to-be-disputed manner the true characteristics of the tubes you are buying and selling—whether they oscillate; how well they detect; how well they amplify; the best operating plate voltage and filament current—and many other things you have wanted to know about your tubes.

Complete in itself, not dependent on broadcasting, it eliminates all guess work. Simple to operate.

The cost?—A negligible sum considering the money it will save you and the satisfied customers it will win. The salvage of a few supposedly-defective tubes will alone pay for it.

Manufactured by W-B-L Radio Co., exclusively for



845 BROAD STREET, NEWARK, N. J.
WESTERN SALES DEPT.: 8405 DETROIT AVE., CLEVELAND, O.

THE RADIO DEALER

Can Meet All Needs of The Radio Fan

With Apparatus Bought from

ELECTRIC SERVICE ENGINEERING CO. AT ANY TIME

SPECIAL ARTICLES

ELECTRIC SERVICE VARIABLE CONDENSER 23 or 43 Plate \$2.00 LIST

Amrad	Immediate Deliveries, Biggest Discounts
Chelsea	Immediate Deliveries, Biggest Discounts
Dubilier	Immediate Deliveries, Biggest Discounts
Fada	Immediate Deliveries, Biggest Discounts
Federal	Immediate Deliveries, Biggest Discounts
General Apparatus	Immediate Deliveries, Biggest Discounts

Complete Stock of HARD-TO-GET ACCESSORIES

Electric Service Engineering Co.

105 West 42nd Street

New York City

Where to Buy

A Handy Guide for the Convenience of Our Readers

AERIALS		Freed-Eisemann Radio Corp..... 58	Holloway Elec. Supply Co..... 82
Walter S. Krenz..... 110		A. C. Gilbert Co..... 26	Julius Andrae & Sons Co..... 56
ARMSTRONG HOOK-UP		Mercury Radio Products Co..... 124	Liberty Radio Co..... 82
Brady Electric Mfg. Co..... 50		Victor Radio Corp..... 19	Morscan Radio Co..... 14
AMPLIFIERS		Union Radio Corp..... 128	Moss Radio Co..... 80
Horning Experimental Laboratories.. 89		COMPOSITION	
F. C. Kent Co..... 80		Diamond State Fibre Co..... 98	
Sheltone Radio Sales Co..... 76		Nuloid Corp..... Inside Back Cover	
AMPLIFIER UNITS		Scheuroth Letonite Co..... 79	
Atwater Kent Mfg. Co..... 49		CONDENSERS	
ANTENNA LIGHT WIRE PLUGS		Chelsea Radio Co..... 4	
General Merchandise Co..... 107		Diamant Tool Mfg. Co..... 101	
The Racony Corp..... 136		Duke Radio Co..... 68	
Super-Antenna Co..... 8		European Radio Co..... 116	
ANTENNA WIRE		Radio Laboratories of New Jersey... 114	
Hintze Bros..... 75		Scheib Elec. Radio Co..... 78	
Copper Clad Steel Co..... 68		Seaboard Radio Corp..... 77	
"B" BATTERIES		The Radio Shop..... 50	
Gould Storage Battery Co..... 11		Tonks Mfg. Co..... 79	
BATTERIES		United Mfg. & Dist. Co..... 70	
Carbon Products Co..... 54		CONDENSER PARTS	
Comet Battery Co..... 90		New Haven Radio Co..... 62	
Economic Appliance Co..... 88		CONTRACT WORK	
French Battery & Carbon Co..... 70		Carlyle Johnson Machine Co..... 58	
Manhattan Storage Battery Co..... 84		COUPLERS	
Novo Manufacturing Co..... 69		Moreland Sales Corp..... 74	
Volton Battery Co., Inc..... 89		CRYSTALS	
BATTERY TESTERS		J. F. Bishop & Co..... 22	
The Chaslyn Co..... 102		Curtis G. Culin..... 102	
BESTONE PRODUCTS		Galena Crystal Mfg. Co..... 102	
Henry Hyman & Co., Inc..... 103		Harris Laboratory..... 106	
BINDING POSTS		Rocky Mountain Radio Products, Inc. 58	
The H. H. Eby Mfg. Co..... 55		U. S. Radio Co. of Penna., Inc..... 106	
Radio Accessories Co..... 91		CRYSTAL DETECTORS	
BOOKS		Ayan-Jay Sales Co..... 6	
Allied Engineering Institute..... 131		Diamant Tool & Mfg. Co., Inc..... 101	
Archway Bookstore..... 66		Randel Wireless Co..... 99	
Great Lakes Publishing Co..... 66		Scott Novelty Co..... 66	
Norman W. Henley Pub. Co..... 71		CRYSTAL SETS	
Martin H. Ray..... 108		Bershaw Radio & Mfg. Co..... 23	
BOXES		T-F Radiophone Co..... 124	
Weis Mfg. Co..... 68		M. P. Radio Co..... 90	
BRASS PARTS		Radio Music Co., Inc..... 21	
McKenna Brass & Mfg. Co..... 80		DIALS	
CABINETS		Alden-Napier Co..... 124	
E. Shoo Cabinet Works..... 79		Box 104..... 92	
Marvin B. Fallgatter..... 102		The Emeloid Co., Inc..... 69	
CABINET SETS		DISTRIBUTORS	
Heinemann Electric Co..... 109		Altadena Radio Laboratories..... 56	
Pittsburgh Radio Supply Co..... 105		American Electro-Phone Co..... 124	
Premier Radio Corp..... 99		Arrow Radio Co..... 58	
CHOKE COILS		Brown Radio Co..... 104	
Thompson-Levering Co..... 95		Detroit Electric Co..... 66	
COIL MOUNTINGS		Detroit Radio Co..... 90	
Astorloid Mfg. Co., Inc..... 53		Elec. Radio Supply Co..... 78	
COMPLETE LINE		Electric Service Engineering Co..... 133	
Adams, Morgan Co..... 129		Eugene T. Turney Laboratories..... 93	
Chelton Electric Co..... 5		Federal Tel. & Tel. Co..... 4	
Clapp Eastham Co..... 58		Frank Radio Co..... 114	
		General Radio Laboratories, Inc..... 41	
		Herbert H. Frost..... 62	
		GLASS	
		Vineland Scientific Glass Co..... 69	
		GRID LEAKS	
		Radiophone Equipment Co..... 78	
		Whitehouse Radio & Mfg. Co..... 82	
		HEAD SETS	
		Alcerno Mfg. Co..... 96	
		General Radio Equipment Mfg. Co... 88	
		Premier Accessory & Specialty Co... 93	
		Royal Electrical Laboratories..... 25	
		Mills Radio & Electric Co..... 104	
		INFORMATION	
		Service Bureau..... 18	
		INSULATION	
		National Fibre & Insulation Co..... 5	
		INSULATORS	
		Hubbard & Co..... 85	
		KNOBS	
		Champlin Mfg. Co..... 126	
		KNOBS & DIALS	
		Tait Knob & Dial Co..... 53	
		LACQUER	
		Zeller Lacquer Mfg. Co., Inc..... 118	
		LIGHTNING ARRESTERS	
		L. S. Brach Mfg. Co..... 60	
		Electric Service Supplies Co..... 6	

Where to Buy

A Handy Guide For the Convenience of Our Readers

LOOP AERIALS		POTENTIOMETERS		TESTING LABORATORIES	
Eagle Radio Co.	86	Advance Metal Stamping Co.	74	N. Y. Testing Laboratories	58
LOUD SPEAKERS		E. M. Wilson & Son	90	THREE COIL MOUNTINGS	
Dictograph Products Corp.	15	RADIO FREQUENCY TRANSFORMERS		Astorloid Mfg. Co.	53
The Magnavox Co.	45	Wireless Phone Corp.	104	York Radio Co.	102
LOUD SPEAKER SETS		Clark & Tilson	128	TRADE MARKS	
General Auto Electric Co.	68	RADIO CRYSTAL ATTACHMENT		Chauncey P. Carter	87
Radio Equipment Service	123	Rad'O	110	Radio Dealer Trade Mark Bureau	56
MAILING LISTS		RADIO TOWERS		TRANSFORMERS	
Chicago Trade Addressing Co.	58	Milliken Bros. Mfg. Co., Inc.	71	Clark and Tilson	128
Radio Red Book Publishing Co.	102	RADIOLITE		Federal Institute of Radio Tele-	
Ross-Gould Co.	62	Radio Equipment Service	12, 13	graphy	7
Sydell's Radio Directory & Service	67	RECEIVING SETS		Ford Mica Co.	69
The Business Bourse International, Inc.	65	Aerex Radiophone Corp.	58	Thornton Transformer Co.	78
MANUFACTURERS' REPRESENTATIVES		Doublell Radio Co.	113	Ideal Eng. Co.	98
Radio Equipment Service	66	Lewis and DeRoy Co.	52	York Radio Co.	102
METALS		Melchior Equipment Co.	84	TUNER AND DETECTOR UNITS	
Strahs Aluminum Co.	102	Midwest Radio Co.	55	Aronax Radio Sales Co.	85
MICA		Minnesota Radio Sales Corp.	24	TUNING COILS	
Meirowsky Bros.	116	Montclair Radio Mfg. Corp.	16	National Radio Co.	80
Mica Insulator Co.	22	Mu-Rad Laboratories, Inc.	9	UNIT TYPE SETS	
MICA DIAPHRAGMS		Paul G. Niehoff Co.	106	Jewett Mfg. Co.	47
Radio Mica Products Co.		Radio Outfitting Corp.	58	VACUUM TUBE TESTER	
MULTILISTENER		Bissell Engineering Co.	74	The Mydar Radio Co., Inc.	133
F. C. Manning Co.	97	Raymond Radio Corp.		VARIABLE CONDENSERS	
NAME PLATES		Inside Front Cover		Bayley Condenser Co.	95
Name Plate Co.	38	Rogers Radio Co.	84	Chelsea Radio Co.	4
PANEL WINDOWS		Joy Kelsey Corp.	84	John Cozzone Co.	87
Stevens	82	States Radio Corp.	92	Duquesne Radio & Mfg. Co.	106
PANELS		Tresco Radio Co.	70	Detroit Radio Supply Co.	102
Beau Ivorie Novelty Co.	124	W. R. Cramer Co.	60	Electric Service Engineering Co.	133
New York Hand Rubber Turning Co.	62	United Radio & Electric Co.	89	Montrose Mfg. Co.	90
Poster & Co.	101	RHEOSTATS		North American Radio Corp.	61
Standard Radio Parts Co.	73	Acorn Radio Supply Co.	83	Radio Laboratory of N. J.	114
The Continental Fibre Co.	83	Harold M. Schwab, Inc.	16	Radio Stores Corp.	136
PAPER TUBES		Parkin Mfg. Co.	65	Spiro Bros.	59
Baehm Paper Co.	58	The Radiola Wireless Corp.	100	White Radio Co.	84
PART MAKERS		Reco Radio Engineering Co.	28	VARIO-COUPPLERS	
Merit Machine Mfg. Co.		Louis A. Staff Co.	59	Maclite Radio Co.	84
Raymond Radio Corporation		Keystone Radio Co.	89	Marvin B. Fallgatter	84
Inside Front Cover		Sunraid Radio Co.	Inside Front Cover	VARIOMETERS	
PATENTS		SALESMEN WANTED		Eastern Specialty Co.	81
A. M. Wilson, Inc.	66	Box H-14, Care Radio Dealer	84	Franklin Radio Mfg. Co.	80
Emil Alexander Kern	90	SCREW MACHINE PRODUCTS		McConnell Cable and Specialty Co.	84
Manufacturers Patent Co.	58	Merit Machine Mfg. Co.	60	Nelson Radio Parts Co.	17
Otto K. Zwingenberger	58	Cap Screw & Nut Co. of America	58	Ritter Wood Work Co.	84
PHONES		SHEET COPPER		Simplex Radio Co.	85
Globe Phone Mfg. Co.	92	McKenna Brass & Mfg. Co.	80	Sound Wave Corp.	77
Standard Electric Sales Co.	106	SOCKET RHEOSTATS		Sunday & Scholtz Co.	54
T-B-H Corporation	60	Ajax Radio Corp.	90	Volta Engineering Co.	82
Tower Mfg. Co.	62	SOLDERING IRONS		VARIOMETERS AND PARTS	
True-Tone Radio Mfg. Co.	50	North Shore Radio Works	60	Scientific Dealers' Supply Co.	62
PHONES REPAIRED		Post Electric Co.	117	VERNIER ADJUSTER	
Montclair Radio Co.	58	SPAGHETTI TUBING		Robinson Specialty Co.	67
PLUGS		Mitchell Rand Mfg. Co.	62	VERNIER CONDENSERS	
North Ward Radio Co.	Front Cover	Mills Radio & Electric Co.	63	Jesser Radio Sales Co.	57
S. S. Novelty Co.	56	Mica Insulator Co.	22	VERNIER RHEOSTATS	
		STOCK BROKERS		Klosner Approved Apparatus Co.	43
		Frank T. Stanton & Co.	62	WINDING	
		SWITCH STOPS		Montclair Radio Co.	58
		Virginia Radio Corporation	83	WOOD PARTS	
		Premier Radio Mfg. Co.	87	R. C. Mills	84

ONE SALE MAKES MANY

When You Sell a RADIO STORES

VARIABLE CONDENSER

RADIO STORES CORP.

it Recommends all RADIO STORES Products.

A Minimum of Sales Effort—Every Sale Makes a Friend.

The RADIO STORES VARIABLE CONDENSER has these advantages:—

Counter weight under dial. Brass studs through aluminum plates and die cast. Shaft held in true center through brass bushings. Binding posts mounted on metal straps. No insulating material tapped—metal inserts throughout. Precision workmanship and best engineering design.

It is made in two sizes, 23 Plate .0005 mfd. capacity and 43 Plate .001 mfd. capacity.

The same applies to the—

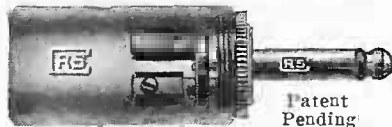

RADIO STORES TORPEDO PLUG
IT'S UNBREAKABLE

All conductive parts are of heavy machined brass, insulated throughout. It has screw binding post terminals, with separate anchor for tail of cord, and is designed to insure rigidity, durability, strength and lightness.



222 West 34th St. New York City

DEALERS: Write for prices and proposition.

Address Department D.

The ONLY Adjustable Plug on the Market

RACONY PLUG

\$3.00 and well worth it

Attach to Any Electric Light Socket

Consumes No Current

Made to Stand 2500 Volts

Genuine Mica Dielectric

This is the ONLY 4 Outlet Plug and has 14 Combinations



The RACONY New Dielectric Plug Complies with All Requirements of the Board of Fire Underwriters

With the Racony plug you can give your customers the BEST on the market and make a handsome PROFIT for yourself.

THE RACONY CORP.

SUCCESSORS TO The Radio Co. of N. Y.

799 Broadway, New York City

No More Aerial or Outside Wires

Electric Socket Attachment Plugs

Made to Standard 2500 Volts

“NULOID”

(A TRADE NAME FOR A SCIENTIFIC COMPOUND ESPECIALLY ADAPTABLE FOR RADIO PANELS AND PARTS)

U. S. Patent No. 1,107,003

“NULOID.” This is a patented and a secret compound, similar in appearance to hard rubber, horn, ivory, marble, made in all colors, for moulding purposes and can be moulded into sheets, rods, tubes, etc., and is a German invention for which we hold the United States and Canadian patent rights.

“NULOID”

has been approved and tested by the leading electrical and radio manufacturers and has been tested by Columbia University in their testing laboratory and was found to resist warping, water, oil, heat and cold; and resists a 23,300 high frequency voltage, on a 3/16th inch thickness of a panel.

“NULOID”

can be worked easily, as it does not chip or break. Can be easily engraved, cut, drilled, threaded, and polished.

“NULOID”

is manufactured in mahogany and other attractive colors.

“NULOID”

is made in our Kenilworth, N. J. factory, thus assuring immediate deliveries.

“NULOID”

panels and parts can be made to the specifications of any manufacturer.

“NULOID”

does not lose its high polish, regardless of climatic conditions.

“NULOID” prices are not higher than hard rubber or other substitutes.

*Manufacturers—Let us estimate on your specifications
Samples cheerfully submitted*

NULOID CORPORATION

119 Chambers Street

New York, N. Y.

LABORATORIES AND FACTORY, KENILWORTH, N. J.

981714



The Radio Public Is Ready to Buy

Are You Ready to Sell Them the Standard, Nationally Advertised Merchandise They Insist Upon?

A new radio buying public, made up of the great majority, who "waited to see what would become of radio," are already buying well and will buy more and more as the season progresses. These cautious folks, however, are insisting upon well-known products of established quality.

You can satisfy this new demand for quality merchandise most profitably and conveniently through the services of *Wholesale Radio Equipment*. Products of sixteen or more of the most important nationally popular manufacturers are always obtainable at attractive prices. Prompt, careful shipment.

Let us show you more about our service. A postal will do the trick!

Establish Your Source of Supply NOW. Place Your Order TODAY!

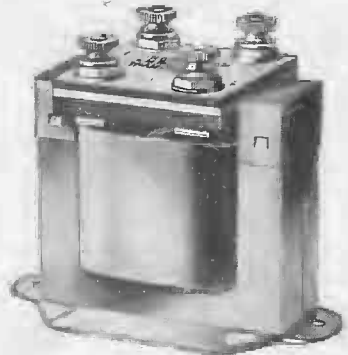

Two Fast-Selling Items THORDARSON

Amplifying Transformers—Shell Type

Low distributed capacity. The core of special 7 mil high silicon steel, is twice the cross section of the ordinary core. Coils wound with silk covered wire, in separate sections, and placed side by side on the core. Mounted on brass or nickel-plated frame. Bakelite terminal board.

LIST \$4.50

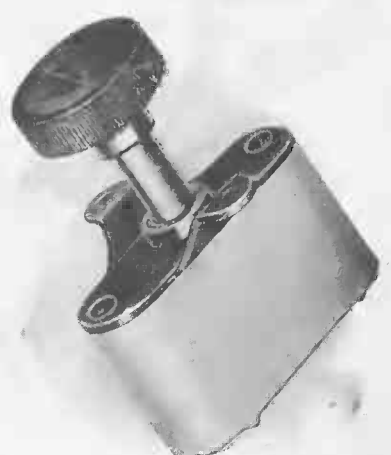

Bradleystat
REGISTERED U.S. PAT. OFF.
PERFECT FILAMENT CONTROL

A graphite compression rheostat that gives absolutely even control of filament current. For 1/2 or 1 ampere detector and amplifier tubes and 5-watt power tubes.

LIST \$1.85

Write For Attractive Discounts

DISTRIBUTORS FOR

- Acme
- Baldwin
- Bradleystat
- Chelsea
- De Forest
- Eveready
- Federal
- Homcharger
- Jefferson
- Klosner
- Magnavox
- Murdock
- Paragon
- Thordarson
- Tuska
- Western Electric

WHOLESALE ONLY!

Wholesale Radio Equipment Co.

24 WILLIAM STREET, NEWARK, N. J.